



2018

**winco**<sup>®</sup>

PROFESSIONAL FOODSERVICE STANDARDS.  
PROFESSIONAL INDUSTRY CHOICE.





# Welcome to **Winco**<sup>®</sup>

We are dedicated to providing a wide range of quality products with chefs and restaurateurs in mind. We deliver quality foodservice products for busy kitchens that enhance food preparation, cooking and dining experiences for operators and patrons.

Since Winco<sup>®</sup> began in 1992, our foundation remains based on the idea that a smallwares and equipment supplier must be able to **deliver quality products as well as partnership services**. These joint strengths, combined with the passion for foodservice, has made Winco<sup>®</sup> a leading brand in the industry.

Today, Winco<sup>®</sup> is best known for **the ideal product mix**, offering exactly what restaurant operators need from front to back of the house. Our ever-growing product range is manufactured to meet the standards of vigorous foodservice establishments and bakeries, a testament to our **core vision: Users deserve reliable, high-quality products without inflated pricing**. Winco<sup>®</sup> products are therefore on-spec for their application, no more and *certainly* no less. Our quality control and consolidation centers in the U.S.A. and overseas are committed to ensuring that the **products meet and exceed all standards**, while obtaining the value of logistics efficiencies, which we in turn pass on to our customers.

Winco<sup>®</sup>'s devoted team has been awarded for some of the **best service**, delivery times and fill rates in the foodservice industry! We have distribution facilities in New Jersey and California for the best stock availability on both coasts.

**For over 25 years you have allowed us to be your partner - Thank you. It is our honor to serve you!**

## *Facilities in California & New Jersey*

Our warehouse in CA houses over 180,000 Sq. Ft. of inventory, for even better stock availability. Conveniently located in La Mirada (less than 20 miles south of Los Angeles), Winco offers fast shipments to all of the West coast.

### *La Mirada, California Facility*



### *Lodi, New Jersey Facility*



#### **WINCO SNAPSHOT**

- ✓ Over 4,500 products
- ✓ 500,000 sq ft. distribution warehouses, 2 locations
- ✓ Over 200 employees
- ✓ Over 70 sales representatives covering North America

**Front of House** 17  
*Dining & Service*

**Dinnerware** 18

<b>Ardesia™ Porcelain</b>	18-27
<b>Ardesia™ Melamine</b>	28-37
<b>Ardesia™ Slate</b>	37

**Cadenza** 40

Monte Carlo	Claret
Isola	Carrera
Ampezzo	Aires

**Flatware & Steak Knives** 46

18/8 Flatware	Hollow Handle Knives
18/0 Flatware	Steak Knives

**Buffet Service** 64

Chafers & Accessories	Juice Dispensers
Chafing Fuel	Serving Trays & Utensils
Coffee Urns	Signs-Clip, Chain, Tent
Electric Water Pan	<b>Virtuoso™ Chafers</b>

**Tabletop** 77

Condiment Dispensers and Sauce/Dessert Cups	Salt Shakers
Fajita Servers & Sizzle Platters	Seafood Trays
Glass Shakers & Caddies	Serving Baskets- Plastic, Woven Poly, Wire
<b>Maestro™ Pepper Mills</b>	Serving Boards & Trays
Mini Baskets & Cups	Snail Server
Mini Cans & Pails	Sugar & Creamers
Mini Cookware/Serveware	Taco & Salsa/Dip Service
Salad Bowls	Tortilla Presses

**Dining Service** 94

Cafeteria/Mess Trays	Order Racks & Check Service
Call Bells & Crumbers	Seafood/Snail Service
Cheese Knives	Serving Trays & Stands
Coat Check	Signs- Stanchion Floor Stands, LED, Information, Braille
Condiment Dispenser	Squeeze Bottles
Cotton Gloves	Straw & Napkin Dispensers
Decorative Picks	Table Covers
Display Boards & Easels	Table Signs & Clips
Electric Tealights	<b>STABLEizer™ Wedges/Shims</b>
Flatware Organizers	Wine Service
Graters, Zesters & Peelers	
Menu Covers & Stands	

**Beverage Service** 114

Airpots & Racks	Juice Dispensers
Beverage Dispensers	Pitchers- Plastic, Stainless Steel
Coffee & Tea Accessories	Plastic Drinkware- Havana-style, Pebbled
Coffee Warmers-Single, Double	Punch Bowl
Cup & Lid Organizers/Racks	Beverage Signs-Chain & Tent
Drip Trays	<b>Virtuoso™ Coffee Urns</b>
French Press	
Insulated Servers	

**Display** 124

Angled Adaptor	Display Boards & Easels
Cake/Dessert Stands	Risers, Bowls & Trays- Acrylic, Plastic, S/S
Display Cases/Covers	Roll-Top Cover
Crocks & Covers-Plastic	

**Bar Supplies** 129

Bar Clean-Up	Insulated Ice Caddy
Bar Liners & Service Mats	Muddlers & Squeezers
Bar Speed Rails	<b>Moscow Mule Mugs</b>
Beer Mug Washer	Non-Slip Trays
<b>Accelmix™ Blenders</b>	Overhead Glass Racks
Bottle Openers & Corkscrews	Pour Bottles
Condiment Holders	Pourers & Stoppers
Drink Prep & Ice Tools	Syrup/Liqueur Pump Kit
	Wine Service

**Kitchen** 145  
*Prep & Cook*

**Professional Cutlery** 146

<b>ACERO™ Forged Cutlery</b>	Protective Gloves
Cheese Knives, Wires, Graters	Sharpening Tools
Cook's/Pot Forks	Shears-Poultry & Herb
<b>COOL HEAT™ Turners</b>	Specialty & Pizza Knives
Knife Storage/Transport	<b>STÅL™ Stamped Cutlery</b>
Professional Cleavers	Steak Knives

**Professional Cookware** 165

Aluminum Cookware	Pan Sleeves & Grabbers
Cast Iron Pans	Roasting Pans
<b>FIRE IRON Cast Iron Skillets</b>	Stainless Steel Cookware
Fryer & Pasta Baskets	<b>TRI-GEN™ Induction-Ready</b>

**Steam Table Pans** 186

Adaptor Bars & Plates	Specialty Pans & Covers
Bain-Maries & Insets	Water & Spillage Pans
False Bottoms	Wire Steam Pan Grates

**Poly Pans & Food Storage** 192

Beverage Container	Food Pans & Covers- <b>Blaze™ High Heat Nylon,</b> Clear & White PC
Dough Boxes, Covers, Dolly	Ingredient Bins & Lids- Mobile, Stackable
Drain Shelves	
Food Storage Containers- Round, Square, Clear, Translucent, White	

**Bakeware** 200

Baking Mats, Silicone	Mixing Tools- Paddles, Spoons & Bowls
Batter Dispensers & Funnels	Muffin & Loaf Pans
Cake Decorating Tools	Pastry Tools- Brushes, Blenders, Wheels, Cutters & Molds
Cake Pans- Round & Rectangle	Rolling Pins
Cookie Sheet & Cutters	Scrapers-Silicone & Plastic
Cooling Racks & Grates	Spatulas
<b>Connoisseur™ Pastry Blender</b>	Sheet Pans
Dough Preparation- Boxes, Proofing Pans, Dockers, Scrapers	Sheet Pan Racks
Doughnut Basket	Sifters & Sieves
Dredges & Lids	Specialty Pans- Tart, Bundt, Baguette & Bread Form
Leveler, Markers, Cutters	Springform Pans
Measuring Tools- Cups, Spoons & Ladles	Timers, Oven Mitts, Pot Holders

**Pizza Supplies** 223

Bubble Poppers	Oven Brushes
Dough Preparation- Boxes, Sifter, Scrapers, Mixing Paddles, Rolling Pins	Perforated Disks
Dredges & Lids	Pan Grippers
Heat Sink	Pizza Pans-Deep Dish, Round, Sicilian & Stackable
Insulated Delivery Bags	Stand & Rack
Mesh Screens	Peels-Aluminum & Wood
Pizza Knives/Cutters Pizza	Servers & Tongs

**Food Preparation** 232

Commercial Can Openers	Manual Prep Tools
Colanders	Mixing Bowls & Stand
Countertop Juice Squeezers	Pasta Maker
Cutting Boards & Mats	Salad Spinners
Dispensers- Batter & Condiment	Scales
Food Mills	<b>STATIKBOARD™ Cutting Boards</b>
<b>Kattex™ Slicers &amp; Cutters</b>	Thermometers
Mandoline Slicers & Blades	Tortilla Press
	Utility Pail

**Kitchen Utensils 251**

- Allergen-Free™ Tools**  
 Basting Covers & Utensils  
 Butter Roller  
 Cook's Forks  
 Culinary Baskets  
 Egg Tools  
 Fryer Accessories  
 Fruit Prep Tools  
 Funnels & Dispensers  
 Graters, Zesters & Peelers  
 Ladles & Dippers  
**Connoisseur™ Mashers**  
**Connoisseur™ Pasta Baskets**  
 Measuring Cups & Spoons  
 Meat Prep Tools  
 Mixing/Stirring Paddles
- Plating Molds & Utensils  
 Protective Gloves  
 Scoops & Rack  
 Scrapers-Plastic & Nylon  
 Serving Tongs-  
 Poly, Heat-Resistant &  
 Stainless Steel  
 Seafood Prep Tools  
 Shears-Herb & Poultry  
 Silicone Brush  
 Spatulas/Turners  
 Spoons-Nylon & Wood  
 Squeeze Bottles  
 Strainers & Skimmers  
 Whips, Stainless Steel  
**Winco Prime® Utensils**

**Apparel 290**

- Aprons, Bib & Waist  
 Chef Hats-Cloth & Disposable
- Signature Chef™ Apparel-**  
 Jackets, Shirts, Pants

**Back of House 294**  
*Clean & Organize*

**Janitorial 295**

- Brushes-Oven & Utility  
 Cleaning Accessories, Towels  
 Floor Care & Floor Mats  
 Gloves & Wall Brackets  
 Grill Maintenance  
 Hood Filters
- Insect Control  
 Janitorial Accessories  
 Restroom Necessities  
 Trash Cans, Lids, Dollies,  
 Receptacle & Wire Cart

**Shelving & Racks 309**

- Dunnage Racks
- Wire Shelving, Sets &  
 Accessories

**Bussing & Transport 313**

- Bus/Dish Boxes & Carts  
 Casters, Universal  
 Dish/Tray Caddy  
 Flatware Organizers
- Hot/Cold Food Transporters  
 Ingredient Bins  
 Sheet Pan Racks  
 Wire Dolly

**Equipment 321**  
*Cook & Merchandise*

**Countertop Equipment 322**

- Accelmix™ Blenders**  
 Beverage Displays-  
 Refrigerated  
 Butane Gas Stove, Portable  
 Coffee Warmers-  
 Single, Double, Tiered  
 Convection Ovens  
 Deep Fryers  
 Electric Water Pan  
 Food Cooker/Warmers -  
 Rectangular & Round  
 Heat Lamps
- Heated Merchandisers  
 Induction Cooker  
**Panasonic® Rice Cooker**  
 Pizza Oven, Electric  
 Rice Cookers/Warmers  
 Sandwich Grills  
**ShowTime!™ -**  
 Cotton Candy Machine,  
 Popcorn Poppers  
 Soup Merchandisers  
 Soup Warmers  
 Strip Heaters

**SPECTRUM 337**

- Electric  
**RollsRight™**
- Gas

**Index 347**

**Icons/Symbols**

Look for these symbols throughout the catalog:



New product introduced since last catalog



Product is packed in display-ready retail packaging (color box, color blister pack, hang tag, etc.)

**Certifications**



Product is NSF® certified and complies with all food safety standards



Product is listed in the CSA® Group Certified Product Listing



Product is ETL™ certified for compliance with accepted national safety standards for USA and Canada



Product is ETL™ certified for compliance with sanitation/food safety standards



Product is UL® certified for compliance with safety standards



Product is UL® certified to be compliant with safety standards for U.S.A. and Canada



**Energy Verified**  
**Rendement**  
**Energétique Vérifié**

Product is UL® certified to be compliant with energy efficiency standards



Product is color-coded for Allergen-Free



Product does not contain Bisphenol-A (BPA)



Product does not contain Perfluorooctanoic Acid (PFOA)



Product is compatible with induction cookers

**Most orders less than pallet loads will be shipped by UPS. Look for these shipping icons to guide freight evaluations.**



Additional oversize fee applies if item ships via UPS®



Item cannot be shipped by UPS®

All product photography © 2018 Winco®  
 DWL Industries Co.

## FRENCH BREAD WOOD BOARD

WCB-225

- ◆ Reversible design made of solid birch wood
- ◆ Hand wash recommended
- ◆ 22-1/2"L x 5-1/2"W x 3/4"H



WCB-225



P.82,  
103 &  
248

AVAILABLE IN  
FEBRUARY 2018

## AIRPOTS

AP/APSP/APSK-SERIES

- ◆ Available with push button or lever top
- ◆ Heat retention: 10 hours at 175°F; 24 hours at 151°F
- ◆ Swivel base for easy access
- ◆ Double-wall insulated
- ◆ Stainless steel satin-finish body
- ◆ Includes four (4) "Lift & Twist" color tags for **Coffee, Decaf, Tea & Hot water**
- ◆ 1.9L Glass lined airpot new size available



NEW  
SIZE



NEW &  
IMPROVED

COLORED  
IDENTIFICATION  
TAGS INCLUDED

"LIFT & TWIST" TAGS  
SUGGESTED FOR  
COFFEE, DECAF,  
TEA & HOT WATER



AP-819

APSP-925

P.116

## STAINLESS STEEL CONDIMENT PACKET HOLDER

SCPH-33

- ◆ Fits various configurations of 1/3, 1/6 and 1/9-size steam table pans\*
- ◆ Ideal for keeping sugar, salt or sauce packets organized
- ◆ Two openings, each measures 12"L x 6-1/8"W
- ◆ Sloped angle allows easy access on crowded countertops



SCPH-33



\*Pans sold separately

AVAILABLE IN  
MARCH 2018

P.106

## 25 OZ GLASS TEAPOT WITH INFUSER BASKET

GTP-25

- ◆ Fine stainless steel mesh strainer
- ◆ Glass carafe cradled in plastic body, suitable for loose tea brewing



AVAILABLE IN  
FEBRUARY 2018



GTP-25



P.120

## ROUND ICE CUBE TRAY

ICCP-6W

- ◆ Made of sturdy, stackable polypropylene
- ◆ Makes six (6) perfectly spherical 2" cubes
- ◆ 2-piece top and bottom tray for easy filling; stackable
- ◆ BPA-free



BPA  
FREE



ICCP-6W



2-piece tray



P.135





TRI-GEN™ TRI-PLY COOKWARE

TGAP/TGBZ/TGET/TGSP/TGFP/TGFP-NS

Tri-Gen™ Tri-ply Stainless Steel Cookware offers a well-balanced cooking experience by combining the beauty and grace of stainless steel with powerful heating properties of aluminum

- ◆ Handles offer excellent comfort and pan control, minimizing hand fatigue for high-volume operators
- ◆ Triangular positioned rivets provide strength - will not loosen in high-volume commercial kitchens
- ◆ Fry Pans available in natural and Excalibur® non-stick finishes
- ◆ Mirror finish exterior, satin finish interior
- ◆ Can be used with any type of cook-top, including induction
- ◆ NSF listed



INDUCTION-READY

**TRI-GEN**<sup>™</sup>  
by winco



NSF



NEXT  
GENERATION  
COOKWARE

Fry Pans  
Sauté Pans  
Sauce Pans  
Stock Pots  
Braziers



TGAP-Series

TGSP-Series

TGBZ-Series

TGET-Series

TGFP-Series

Nonstick Fry Pans





### STÄL PARING KNIFE BULK PACK

KWP-3046

- ◆ 3-1/4" paring knife made of X50 Cr Mo V15 German Steel
- ◆ Ergonomic, slip-resistant polypropylene handle is comfortable and reduces hand fatigue
- ◆ Protective finger guard
- ◆ Includes seven (7) handle colors
- ◆ NSF listed



KWP-3046

P.154

### WINCO® SPREADER BULK PACK

TWP-3135

- ◆ Assortment of seven (7) colors included in convenient display bucket
- ◆ 3-5/8" spreader with stainless steel, satin finish blade
- ◆ Slip-free comfort grip
- ◆ NSF listed



TWP-3135

P.154 & 273

### KNIFE BACKPACK AND INNER CASE

KBP-SERIES

- ◆ Backpack features wide, ergonomic straps with a back airflow system for extra comfort
- ◆ Padded laptop sleeve compartment with locking zippers
- ◆ Perfectly accommodates Winco's KBP-2 hard case
- ◆ The KBP-2 hard case has 10 slots to fit a variety of knives; has removable strap, which can be used for carrying without backpack



KBP-2  
Hard Case

KBP-S  
Backpack and Inner Case set

Easy-access lined top pocket fits glasses or cell phone

Wide, ergonomic shoulder straps with zippered stash pocket

Lockable zippers on compartment that fits a standard laptop

Securely lock zippers on large main compartment

Audio interface and zipper pocket on front

Airflow back system for extra comfort

Internal zipper pockets for wallet or valuables

Wide mesh pocket on each side, great for water bottle



KBP-1

P.159

### KNIFE BLADE GUARDS

KGD-SERIES

- ◆ Ideal for stamped or forged blades
- ◆ Felt interior prevents dulling
- ◆ Available in eight (8) sizes



AVAILABLE IN MARCH 2018



KGD-41 Blade guard with KWP-30 knife



KGD-815 Blade guard with KFP-80 knife

P.156

## 7 PC STÄL CUTLERY KIT

### KWP-KIT1

- ◆ Stäl stamped series offers exceptional quality
- ◆ Knives are NSF listed and have ergonomic, slip-resistant handles
- ◆ Rapid sharpening, easy edge maintenance
- ◆ Includes paring, utility, boning, offset bread, chef, slicer, sharpening steel and knife case
- ◆ Bonus red nylon spoon included
- ◆ NSF listed



**BONUS  
HIGH-HEAT  
NYLON SPOON  
INCLUDED**



KWP-KIT1



P.154

## 6" CURVED COOK'S FORK

### KFP-62

- ◆ Extra heavyweight
- ◆ 6" curved prongs
- ◆ NSF listed



AVAILABLE IN  
FEBRUARY 2018



KFP-62

P.148  
&288

## ACCELMIX™ 44 OZ BAR BLENDER

### XLB-44

- ◆ 44 oz, break-resistant and BPA-free Tritan™ container
- ◆ Quiet, high-performance 1/2 hp self-lubricating motor; uniquely designed high-impact blades
- ◆ HIGH/LOW toggle switch for precise consistency control
- ◆ Blade is removable for easy cleaning
- ◆ Non-skid feet securely grip the surface for stable operation
- ◆ Removable container covers and caps for adding/blending ingredients mid-cycle
- ◆ All parts (except bases) are dishwasher safe
- ◆ ETL listed for electrical safety in US and Canada, conforms to UL-197 and CSA C22.2
- ◆ 120V~60Hz, 400W, 3.5A
- ◆ Overall: 7"L x 5"W x 15-1/4"H; container: 7"L x 5"W x 9"H
- ◆ One year parts and labor warranty



**BPA  
FREE**



XLB-44

P.134  
&322

**ACCELMIX**™  
by Winco®



### FIREIRON™ CAST-IRON SKILLETS



#### CAST-SERIES

- ◆ Fine, smooth surface for excellent sear; also sauté, fry, boil, braise, bake and roast
- ◆ Widened handle with thumbrest for comfortable grip and better handling
- ◆ Induction ready; multiple cooking surfaces compatible
- ◆ Available in four (4) sizes



P.175

### 10" ALUMINUM GYRO PAN

#### AGP-10

- ◆ Ergonomically designed, insulated silicone handle is heat-resistant up to 450°F (230°C)
- ◆ NSF listed



HANDLE WITHSTANDS TEMPS UP TO 450°F



AGP-10



P.182

### ALUMINUM STRAIGHT-SIDED SAUCE PANS

#### ASP-SERIES

- ◆ 3003 Aluminum
- ◆ Broad base offers widest area for optimal heating; ideal for cooking sauces or vegetables
- ◆ 4.0mm thickness
- ◆ Available in four (4) new sizes
- ◆ NSF listed



ASP-6SW

P.182

AVAILABLE IN FEBRUARY 2018

### CHIMICHANGA/BURRITO FRY BASKET

#### FB-03

- ◆ Heavy gauge wire handle coated with high-temperature resistant colored plastic
- ◆ Commercial quality 18/8 stainless steel
- ◆ Two hinged wire shelves; front and side hooks

FB-03

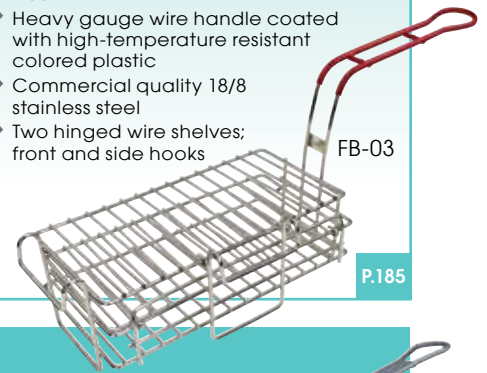

P.185

### FRY BASKETS

#### FB-SERIES

- ◆ One piece construction, non-welded structure
- ◆ Long lasting frame
- ◆ Heavy gauge wire handles are coated with high-temperature resistant colored plastic
- ◆ Nickel plated
- ◆ Available in three (3) new sizes



FB-05

FB-25

FB-35

P.185



## ALUMINUM BAGUETTE PANS

### ABP-SERIES

- ◆ 3003 Aluminum
- ◆ Non-stick coating for easy release
- ◆ Heat circulates through the perforations while cooking, resulting in crispy crusts while bread inside stays soft
- ◆ Commercial-grade quality
- ◆ All pans are 18" x 26"; variety of slot options
- ◆ PTFE/PFOA-free

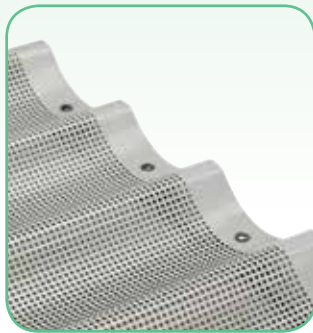

Perforations

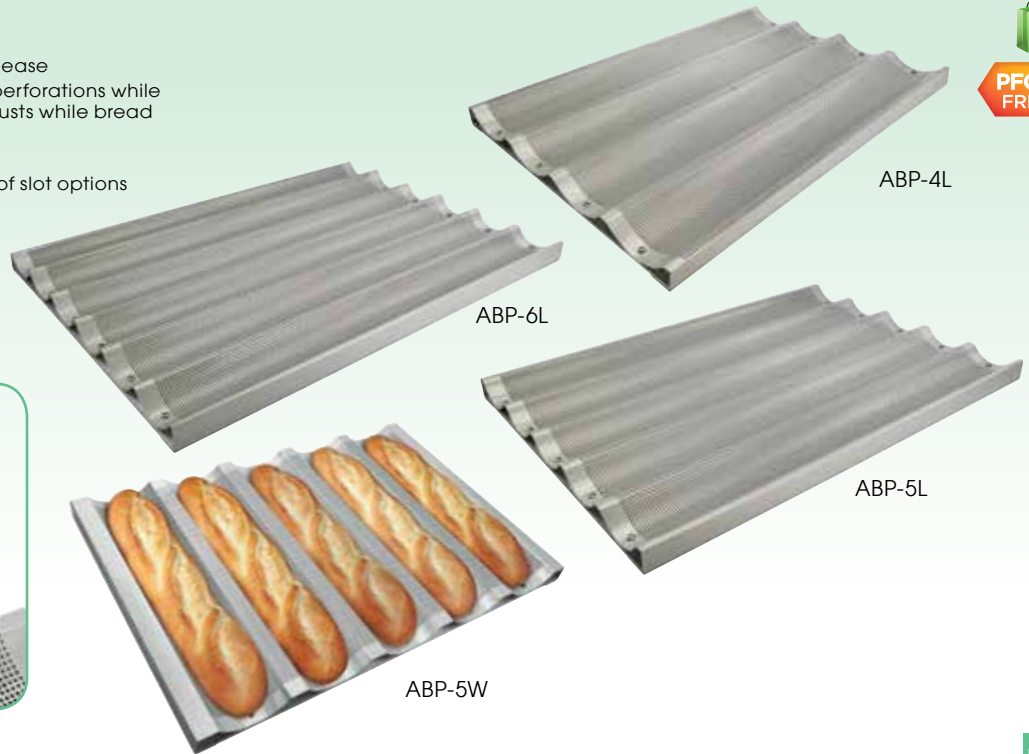

P.205

## STAINLESS STEEL STEAM TABLE PANS

### SPJH-SERIES

- ◆ 22 gauge perforated steam pans are available in six (6) new sizes
- ◆ 22 gauge half-long steam pans are anti-jamming and available in five (5) new sizes
- ◆ NSF listed



SPJH/SPFP-SERIES  
PERFORATED STEAM PANS



SPJH/SPJL-SERIES  
HALF-LONG SIZE PANS

P.187

## NINTH-SIZE STEAM PAN FLAT COVERS

### SPSCN-GN & SPCN-GN

- ◆ SPSCN-GN - 1/9 size solid cover for SPJH-906GN steam table pan
- ◆ SPCN-GN - 1/9 size slotted cover for SPJH-906GN steam table pan
- ◆ 18/8 stainless steel
- ◆ NSF listed

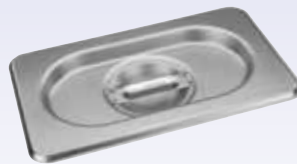

SPSCN-GN  
Solid



SPCN-GN  
Slotted

P.188

## NINTH-SIZE FOOD PAN

### SP7906

- ◆ Fits 1/9 size, 6" deep
- ◆ NSF listed



WITHSTAND  
TEMPS FROM  
-40°F TO 210°F



SP7906

P.193

## NINTH-SIZE DRAIN SHELF

### SP79DS

- ◆ Fits 1/9 size
- ◆ NSF listed



WITHSTAND  
TEMPS FROM  
-40°F TO 210°F

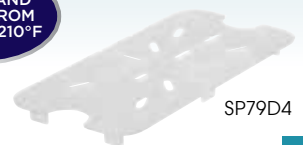

SP79D4

P.193

### HIGH-HEAT NYLON FOOD PANS, COVERS & DRAIN SHELVES

#### HHP-SERIES

Resistant to high temperatures, these pans can be used in the microwave, in the oven and on steam tables.

- ◆ Reinforced, rounded edges for added strength
- ◆ Easily transport from cold storage to warm applications
- ◆ Dishwasher safe
- ◆ NSF listed; BPA-free

**Blaze™**  
HIGH HEAT PANS  
By Winco®

NSF

BPA FREE

AVAILABLE IN  
MARCH 2018

WITHSTAND  
TEMPS FROM  
-40°F TO 400°F



HHP204



HHP304



HHP300S



DRAIN SHELVES

P.192

### QUARTER-SIZE SHEET PAN COVER

#### CXP-1013

- ◆ Protects food products during transport or storage
- ◆ Excellent reusable alternative to film or foil
- ◆ Polypropylene plastic; Dishwasher safe
- ◆ NSF listed; BPA-free



CXP-1013  
(sheet pan sold separately)

NSF

NEW  
SIZE

BPA  
FREE

P.201

### DOUGH SCRAPER

#### DSC-2W

- ◆ Stainless steel
- ◆ Plastic handle, NSF listed



DSC-2W



NSF

NEW  
COLOR

P.214  
& 229

### 8-CUP MINI LOAF PAN

#### HLF-8MN

- ◆ Heavy-duty carbon steel with premium non-stick coating
- ◆ Makes eight (8) mini loaves
- ◆ Withstands temperatures up to 410°F (210°C)
- ◆ Dishwasher safe
- ◆ PTFE/PFOA-free



WITHSTAND  
TEMPS UP TO  
410°F (210°C)



HLF-8MN



PFOA  
FREE

P.208





## STATIK BOARD™ CUTTING BOARDS

### CBN-SERIES

- ◆ Built-in hook for easy transport and hygienic storage
- ◆ Rubberized feet grip flat surfaces; rubberized sides keep the board upright without sliding
- ◆ Available in three (3) popular sizes
- ◆ HACCP color-coding system to minimize cross-contact
- ◆ Tough board surface reduces knife dulling; durable co-polymer prevents warping
- ◆ Dishwasher safe
- ◆ NSF listed; BPA-free

**NEW & IMPROVED DESIGN**



EDGES OF THE NON-SLIP FEET HELP PREVENT BOARDS FROM SLIDING WHEN STORED VERTICALLY WITHOUT RACKS

STATIKboard™



NSF

BPA FREE



P.247

## KATTEX CHEESE SLICERS

### TCT-375 & TCT-750

- ◆ Cast aluminum construction with stainless steel wires
- ◆ Dimensions (closed): 13.2"L x 6.7"W x 4.5"H
- ◆ Cuts 3/8" or 3/4" cheese sticks, cubes or slices
- ◆ NSF listed

**KATTEX**



NSF

AVAILABLE IN MARCH 2018



CLOSED

P.235





### Step up to Winco® Prime – A Cut Above

Winco® Prime products are made with industry approved materials that comply with or exceed accepted industry standards. All products in the Winco Prime family are NSF® listed to give a comfort level that every effort has been made to provide a safe and durable product at an affordable price. Winco Prime products are safe to be used and will hold up well in the most demanding food service environment!



 FPSN/FPPN-SERIES PORTIONERS



BAMN/INSN/INSC-SERIES BAIN-MAIRES, INSETS & LIDS



 BSON/BSPN/BSSN-SERIES  
BHON/BHPN/BHSN-SERIES BASTING SPOONS



 ICOP-SERIES DISHERS

 Right Hand Indicator



 LDCN/LDIN-SERIES LADLES



P.190,  
256  
-259

## STAINLESS STEEL SHORT HANDLE LADLES

### LDI-SERIES

- ◆ Stainless steel
- ◆ Highly polished mirror finish
- ◆ Available in three (3) sizes

**NEW SIZES**

**HIGHLY POLISHED MIRROR FINISH**



P.261

## ONE-PIECE STEAK WEIGHT WITH SILICONE SLEEVE

### SWS-74

- ◆ Unique one-piece design
- ◆ Can be stacked/nested together for heavier weight
- ◆ Handle is heat-resistant up to 450°F (230°C)
- ◆ NSF listed



NSF®

**AVAILABLE IN FEBRUARY 2018**



*Each weight sold separately*



## FISH BONE TWEEZERS

### TTG5-2PK

- ◆ Ideal for removing fish pin bones
- ◆ Stainless steel
- ◆ Dishwasher safe



**AVAILABLE IN FEBRUARY 2018**

**2 PCS PER PACK**



## SILICONE BRUSH

### SB-175R

- ◆ Non-stick friendly and easy to clean
- ◆ 100% silicone exterior; stainless steel interior
- ◆ Heat resistant up to 428°F (220°C)
- ◆ Dishwasher safe for easier cleanup
- ◆ BPA-free



**BPA FREE**



**HEAT RESISTANT UP TO 428°F**

P.219, 267

## NYLON WHISK

### NC-WP

- ◆ Non-stick friendly
- ◆ Heat resistant up to 410°F (210°C)
- ◆ BPA-free



**BPA FREE**



**HEAT RESISTANT UP TO 410°F**



P.267





### 20-TIER NESTING RACK WITH BRAKES

#### ALZK-20BK & AWZK-20

- ◆ Z-frame nesting design for compact storage
- ◆ Sturdy aluminum structure
- ◆ Capacity: up to 650 lbs & 20 full-size (18" x 26") sheet pans
- ◆ Full-swivel casters; two (2) with brake
- ◆ 3" spacing between each tier
- ◆ Fully assembled: 22" L x 27-1/2"W x 70"H
- ◆ NSF listed



AVAILABLE  
EITHER KNOCKED  
DOWN OR  
WELDED



ALRC-5STK  
caster "5  
with brake

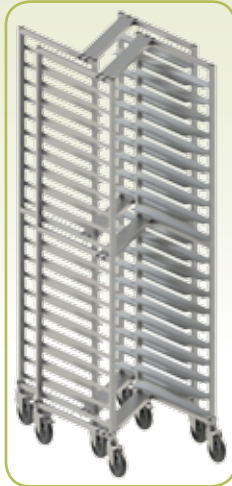

NESTING STYLE

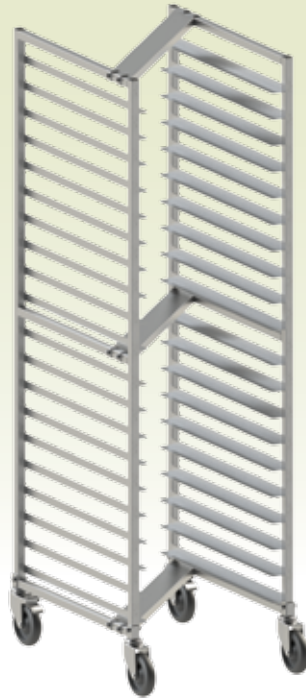

ALRK-20BK

P.203  
&315

### SLENDER TRASH CAN WITH SPECIALTY LID

#### PTC-23GR & PTCB-23GR

- ◆ Lid sold separately



PTCB-23GR



PTC-23GR

P.296

### GRAY POLYPROPYLENE LUG BOX LID

#### PL-8C

- ◆ Fits PL-8 lug box
- ◆ Containers can nest together, stack across each other and stack with lids on
- ◆ BPA-free

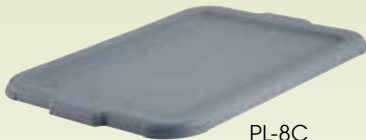

PL-8C



Conveniently nest  
together



Stackable

P.317

### 12" W FLOOR SCRUB BRUSH

#### BRF-12Y

- ◆ Multi-angle brush; works best for cleaning around hard-to-reach places
- ◆ Angled side bristles are ideal for baseboards, under counters and around corners



BRF-12Y

P.300

### STAINLESS STEEL HOOD FILTER

#### HFS-2520

- ◆ Easily clean with degreaser, soap and water, or in the dishwasher



HFS-2520

P.308

### HEAVY-DUTY ALUMINUM GRILL SCRAPER

#### SCRP-14

- ◆ Sharp 6" wide blade
- ◆ Ergonomic top-grip for efficient anti-fatigue handling
- ◆ Dual-grip to apply added pressure to remove grease and grime from flat tops and griddles
- ◆ Splash-guard deflects and helps collect debris for easy cleanup



SCRP-14



SCRP-6B  
Replacement blade

P.305

AVAILABLE IN  
MARCH 2018



### COMMERCIAL ELECTRIC INDUCTION COOKER, 3200W

#### EIC-400B

- ◆ Digitally controlled wattage and temperature
- ◆ Strong, enduring 11" x 11" German SCHOTT™ ceramic glass cooking surface
- ◆ Adjustable heat from 120°F to 460°F (50°C to 240°C)
- ◆ Durable stainless steel body construction
- ◆ Timer up to 150 min (2-1/2 hours)
- ◆ Feet are adjustable for added stability
- ◆ Auto safety shut-off at 2-1/2 hours
- ◆ EIC-400B: 240V~60Hz, 3200W, 13.3A
- ◆ Dimensions: 16-1/2"L x 13"W x 4"H
- ◆ One year warranty

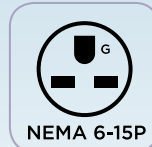

Plug type



**HIGHER POWER  
FASTER COOKING  
240V, 3200W**

EIC-400B

P.332

### 11QT ROUND FOOD COOKER/WARMER, 1250W

#### FW-11R500

- ◆ Insulated heating compartment for maximum efficiency
- ◆ No-drip rim keeps serving area clean
- ◆ Heats up to 212°F (100°C)
- ◆ ETL listed for electrical safety, conforms to UL-197
- ◆ ETL listed for sanitation, conforms to NSF-4
- ◆ 120V~60Hz, 1250W, 10.5A
- ◆ Overall Dimensions: 12-1/2"L x 12-1/2"W x 9-5/8"H
- ◆ Inner well fits 11qt inset pot\*
- ◆ One year parts and labor warranty



\*Inset pot sold separately



FW-11R500

P.327

### ACCELMIX™ 44 OZ BAR BLENDER

#### XLB-44

- ◆ 44 oz, break-resistant and BPA-free Tritan™ container
- ◆ Quiet, high-performance 1/2 hp self-lubricating motor; uniquely designed high-impact blades
- ◆ HIGH/LOW toggle switch for precise consistency control
- ◆ Blade is removable for easy cleaning
- ◆ Non-skid feet securely grip the surface for stable operation
- ◆ Removable container covers and caps for adding/blending ingredients mid-cycle
- ◆ All parts (except bases) are dishwasher safe
- ◆ ETL listed for electrical safety in US and Canada, conforms to UL-197 and CSA C22.2
- ◆ 120V~60Hz, 400W, 3.5A
- ◆ Overall: 7"L x 5"W x 15-1/4"H; container: 7"L x 5"W x 9"H
- ◆ One year parts and labor warranty



### ACCELMIX™ by Winco®



**BPA FREE**

XLB-44

P.134  
&322



## ELECTRIC STRIP HEATERS

### ESH-SERIES

- ◆ Ideal for pass-through stations
- ◆ Each unit includes: undermount bracket set w/screws (ESH-UB), hanging chains (ESH-CH), built-in cord w/plug to easily connect to electrical outlet
- ◆ Heavy-duty aluminum construction
- ◆ Tubular sheath heating element provides constant and reliable infrared heating
- ◆ Five (5) lengths: 24"L / 36"L / 48"L / 60"L / 72"L
- ◆ One year parts and labor warranty

INCLUDES  
HANGING  
CHAINS

BUILT-IN  
PLUG



Heating element



Undermount  
bracket  
without chain



ESH-SERIES  
(36" SHOWN)

AVAILABLE LENGTHS: 24", 36", 48", 60" & 72"

P.328

## COUNTERTOP SINGLE PANINI GRILL

### EPG-1C

- ◆ Ribbed cast iron 14" x 12" grill surface
- ◆ Hinged balanced top plate adjusts to food thickness
- ◆ Removable crumb and grease tray
- ◆ Power and ready light(s)
- ◆ Stainless steel construction
- ◆ Adjustable thermostat(s) up to 570°F
- ◆ ETL listed for electrical safety in US and Canada, conforms to UL-197 and CSA C22.2
- ◆ ETL listed for sanitation, conforms to NSF-4
- ◆ 120V~60Hz, 1800W, 15A
- ◆ One year parts and labor warranty



NEW &  
IMPROVED  
QUALITY



Closed



P.331

# FRONT OF HOUSE

*Dining & Service*



# PORCELAIN

Start a new collection or build on existing tableware with the versatile **porcelain** collections from Ardesia™ by Winco®. Find inspiration in the clean lines, bright whites and geometric forms that effortlessly assist culinary creation and presentation. Discover the wide range of porcelain selections from Ardesia™ by Winco® to achieve the perfect setting.



**ZENDO™** *A Touch of Contemporary*  
*Linear Embossment*  
 Bright White Porcelain

ITEM	DESCRIPTION	SIZE	CAPACITY	UOM	QTY/CASE
A	WDP022-101	Wide Rim Bowl	7-1/4" Dia	3 Oz	Case 36-Pcs
B	WDP022-102	Wide Rim Bowl	9" Dia	6 Oz	Case 24-Pcs
C	WDP022-103	Wide Rim Bowl	10-1/2" Dia	10 Oz	Case 12-Pcs
D	WDP022-104	Wide Rim Bowl	12" Dia	14 Oz	Case 12-Pcs
E	WDP022-105	Round Plate	6-1/2" Dia	Case	48-Pcs
F	WDP022-106	Round Plate	8-1/8" Dia	Case	36-Pcs
G	WDP022-107	Round Plate	9" Dia	Case	24-Pcs
H	WDP022-108	Round Plate	10" Dia	Case	24-Pcs
I	WDP022-109	Round Plate	11-1/8" Dia	Case	12-Pcs
J	WDP022-110	Round Plate	12-1/8" Dia	Case	12-Pcs
K	WDP022-111	Coffee Cup	3-1/4" Dia	6 Oz	Case 36-Pcs
L	WDP022-112	Round Saucer	6" Dia	Case	36-Pcs

**OCEA™** *A Combination of Modern and Traditional*  
 Creamy White Porcelain

ITEM	DESCRIPTION	SIZE	CAPACITY	UOM	QTY/CASE
M	WDP004-201	Oval Plate	8" L	Case	24-Pcs
N	WDP004-202	Oval Plate	10" L	Case	24-Pcs
O	WDP004-203	Oval Plate	12" L	Case	12-Pcs
P	WDP004-204	Oval Plate	14" L	Case	12-Pcs
Q	WDP004-205	Oval Rim Rnd Bowl	4" Dia	3 Oz	Case 36-Pcs
R	WDP004-206	Oval Rim Rnd Bowl	6" Dia	10 Oz	Case 24-Pcs
S	WDP004-207	Oval Rim Rnd Bowl	8" Dia	20 Oz	Case 24-Pcs
T	WDP004-208	Oval Rim Rnd Bowl	10" Dia	50 Oz	Case 12-Pcs
U	WDP004-209	Oval Dish	10" x 7-7/8"	Case	24-Pcs
V	WDP004-210	Oval Dish	12" x 9-1/8"	Case	12-Pcs
W	WDP004-211	Oval Dish	14" x 10-1/4"	Case	12-Pcs
X	WDP004-212	Oval Dish	16" x 12-1/4"	Case	6-Pcs
Y	WDP004-213	Oval Dish	18" x 13-5/8"	Case	6-Pcs
Z	WDP004-214	Coffee Cup	3-1/2" Dia	6 Oz	Case 36-Pcs
AA	WDP004-215	Oval Saucer	6-1/4" x 5-1/2"	Case	36-Pcs





# FALETTE™ *The Natural Wave*

Bright White Porcelain

ITEM	DESCRIPTION	SIZE	UOM	QTY/CASE
A	WDP010-101	Square Plate	9" Sq	Case 12-Pcs
B	WDP010-102	Square Plate	10" Sq	Case 12-Pcs
C	WDP010-103	Square Plate	12" Sq	Case 6-Pcs



# CRAMONT™ *The Windmill*

Bright White Porcelain

ITEM	DESCRIPTION	SIZE	UOM	QTY/CASE
D	WDP011-101	Square Plate	6" Sq	Case 36-Pcs
E	WDP011-102	Square Plate	7-1/2" Sq	Case 24-Pcs
F	WDP011-103	Square Plate	9-1/4" Sq	Case 12-Pcs



# BETTINI™ *The Timeless Unparalleled Rim*

Bright White Porcelain

ITEM	DESCRIPTION	SIZE	UOM	QTY/CASE
G	WDP009-101	Square Plate	7-1/2" Sq	Case 24-Pcs
H	WDP009-102	Square Plate	11" Sq	Case 12-Pcs
I	WDP009-103	Square Plate	14" Sq	Case 6-Pcs





# MAZARRI™ *Uniquely Engraved*

Bright White Porcelain

ITEM	DESCRIPTION	SIZE	UOM	QTY/CASE
J	WDP007-101	Round Plate	10" Dia	Case 12-Pcs
K	WDP007-102	Round Plate	10" Dia	Case 12-Pcs
L	WDP007-103	Round Plate	12" Dia	Case 12-Pcs



J K L

# CARZOLA™ *The Elevated Creativity*

Bright White Porcelain

ITEM	DESCRIPTION	SIZE	CAPACITY	UOM	QTY/CASE
M	WDP005-101	Square Bowl	6-1/4" Sq (5-1/2" Dia)	4 Oz	Case 36-Pcs
N	WDP005-102	Square Bowl	7-3/4" Sq (6-3/4" Dia)	10 Oz	Case 24-Pcs
O	WDP005-103	Square Bowl	10" Sq (8-1/2" Dia)	22 Oz	Case 12-Pcs



O N M

# BERGOMI™ *The Cozy Curve*

Creamy White Porcelain

ITEM	DESCRIPTION	SIZE	CAPACITY	UOM	QTY/CASE
P	WDP006-201	Oval Plate	8" L	Case	36-Pcs
Q	WDP006-202	Oval Plate	10-1/4" L	Case	12-Pcs
R	WDP006-203	Oval Plate	12-1/2" L	Case	12-Pcs
S	WDP006-204	Oval Bowl	8" L	6 Oz	Case 36-Pcs
T	WDP006-205	Oval Bowl	11" L	14 Oz	Case 12-Pcs
U	WDP006-206	Oval Bowl	13" L	20 Oz	Case 12-Pcs



S

P

Q

R



## RIMINI™ *The Imperfect Perfection*

Creamy White Porcelain

ITEM	DESCRIPTION	SIZE	CAPACITY	UOM	QTY/CASE
A	WDP003-201 Angled Bowl	6-1/2" Dia	0.5 Qt	Case	36-Pcs
B	WDP003-202 Angled Bowl	8-1/4" Dia	1 Qt	Case	12-Pcs
C	WDP003-203 Angled Bowl	9-1/2" Dia	1.5 Qt	Case	12-Pcs
D	WDP003-204 Angled Cup	5" Dia x 3-3/4"H	6 Oz	Case	24-Pcs
E	WDP003-205 Angled Cup	5" Dia x 5"H	8 Oz	Case	24-Pcs



## LAURETS™ *The Rounded Square*

Bright White Porcelain

ITEM	DESCRIPTION	SIZE	CAPACITY	UOM	QTY/CASE
F	WDP008-101 Square Bowl	4-1/2" Sq	9 Oz	Case	24-Pcs
G	WDP008-102 Square Bowl	6-1/4" Sq	20 Oz	Case	24-Pcs
H	WDP008-103 Square Bowl	6-3/4" Sq	1 Qt	Case	24-Pcs
I	WDP008-104 Square Bowl	7-5/8" Sq	1.5 Qt	Case	12-Pcs



## SEFTON™ *Rimless Square*

Bright White Porcelain

ITEM	DESCRIPTION	SIZE	CAPACITY	UOM	QTY/CASE
J	WDP019-101 Square Dish	10" Sq	1.5 Qt	Case	12-Pcs



# CALACATTA™ *Rustic Completion*

Creamy White Porcelain with Marble Effect

ITEM	DESCRIPTION	SIZE	UOM	QTY/PACK
K	WDP001-201	Rectangular Platter 10" x 4-3/4"	Pack	4-Pcs
L	WDP001-202	Rectangular Platter 12" x 5-1/2"	Pack	2-Pcs
M	WDP001-203	Rectangular Platter 13-7/8" x 6"	Pack	2-Pcs
N	WDP001-204	Rectangular Platter 16-1/2" x 7"	Pack	2-Pcs
O	WDP001-205	Square Platter 6-7/8" Sq	Pack	4-Pcs
P	WDP001-206	Square Platter 8-1/2" Sq	Pack	4-Pcs
Q	WDP001-207	Square Platter 10-1/4" Sq	Pack	3-Pcs
R	WDP001-208	Square Platter 11-7/8" Sq	Pack	2-Pcs
S	WDP001-209	Square Platter 14-1/8" Sq	Pack	2-Pcs



# DALMATIA™ *From the Harvest*

Creamy White Porcelain with Wood Grain Effect

ITEM	DESCRIPTION	SIZE	UOM	QTY/PACK
T	WDP002-201	Rectangular Platter 12" x 7"	Pack	2-Pcs
U	WDP002-202	Rectangular Platter 14" x 8-1/8"	Pack	2-Pcs
V	WDP002-203	Rectangular Platter 15-3/4" x 9-1/8"	Pack	2-Pcs
W	WDP002-204	Rectangular Platter 15-1/8" x 10-5/8"	Pack	2-Pcs
X	WDP002-205	Square Platter 10-1/4" Sq	Pack	3-Pcs
Y	WDP002-206	Square Platter 12" Sq	Pack	2-Pcs
Z	WDP002-207	Square Platter 14" Sq	Pack	2-Pcs



# VISCA™ *Classic with a Twist of Nature*

Black & White Dual Textured Porcelain

ITEM	DESCRIPTION	SIZE	UOM	QTY/PACK
AA	WDP023-201	Rectangular Platter 11-5/8" x 7-1/4"	Pack	2-Pcs
BB	WDP023-202	Rectangular Platter 13-1/2" x 8-1/2"	Pack	2-Pcs
CC	WDP023-203	Rectangular Platter 15-1/2" x 10"	Pack	2-Pcs
DD	WDP023-204	Square Platter 11" Sq	Pack	2-Pcs
EE	WDP023-205	Square Platter 13" Sq	Pack	2-Pcs

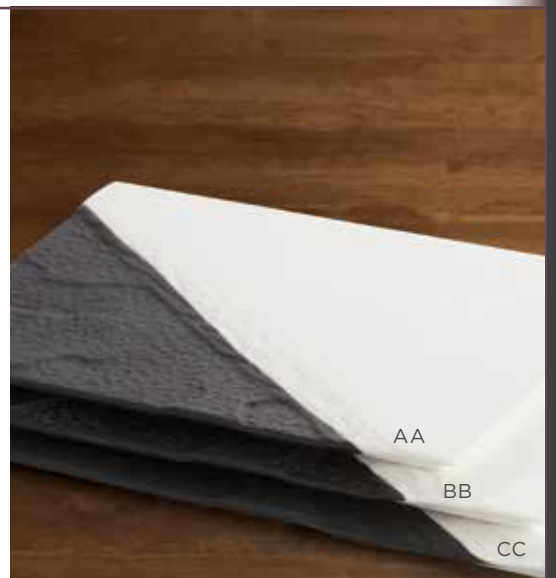

# PAREDES™ *Simple Presentation*

Bright White Porcelain

ITEM	DESCRIPTION	SIZE	UOM	QTY/CASE
A	WDP017-115	Rectangular Platter 12" x 3-3/4"	Case	24-Pcs
B	WDP017-116	Rectangular Platter 14" x 4-1/2"	Case	24-Pcs
C	WDP017-117	Rectangular Platter 16-1/4" x 5"	Case	12-Pcs
D	WDP017-118	Rectangular Platter 17-3/4" x 5-1/2"	Case	12-Pcs
E	WDP017-119	Rectangular Platter 20-1/4" x 6-1/8"	Case	6-Pcs

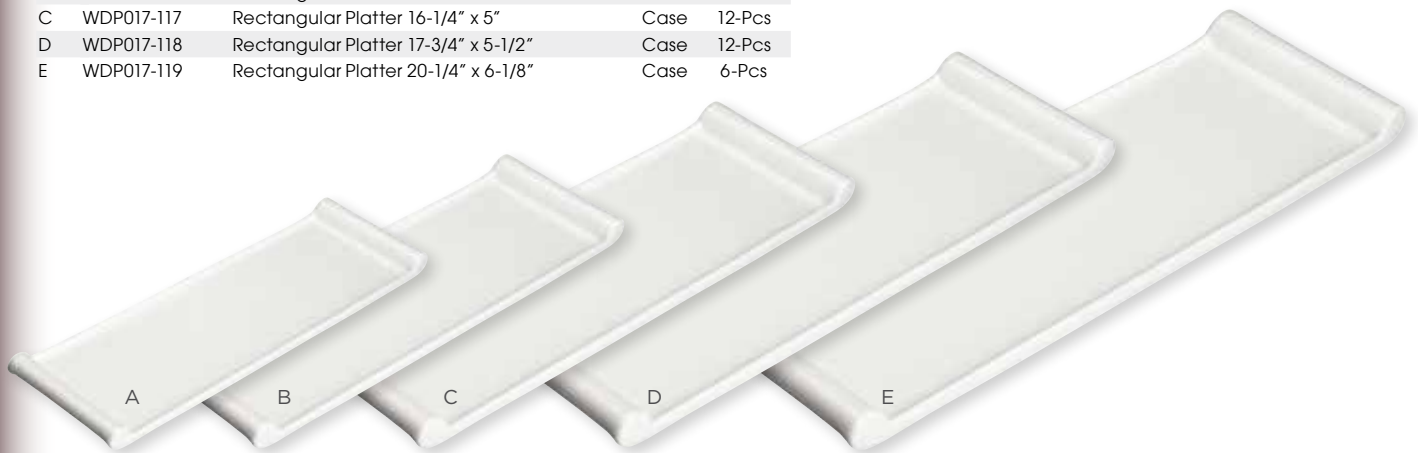

# LOURES™ *To Accessorize*

Bright White Porcelain

ITEM	DESCRIPTION	SIZE	CAPACITY	UOM	QTY/CASE
F	WDP017-101	Trio Bowl 14-1/4" x 4"	24 oz	Case	24-Pcs
G	WDP017-102	Trio Bowl 13-1/4" x 5"	50 oz	Case	12-Pcs
H	WDP017-103	Trio Caddy Bowl 7-3/4" x 5"	10 oz	Case	24-Pcs
I	WDP017-104	Trio Bowl 8-3/4" x 3"	5 oz	Case	36-Pcs
J	WDP017-105	Quartet Bowl 11-7/8" x 3"	7.5 oz	Case	36-Pcs
K	WDP017-106	Duo Dish 6"L (2-3/4" Dia Ea)	2 oz	Case	36-Pcs
L	WDP017-107	Trio Dish 9-1/2"L (2-3/4" Dia Ea)	2 oz	Case	36-Pcs
M	WDP017-108	Trio Tray 10" x 5"		Case	24-Pcs
N	WDP017-109	Duo Plate 13-7/8" x 8"		Case	12-Pcs
O	WDP017-110	Oblong Plate 15-1/4" x 6-1/2"		Case	12-Pcs





Modern Departure **TALLARO™**  
Bright White Porcelain

ITEM	DESCRIPTION	SIZE	UOM	QTY/CASE
P	WDP017-111	Rectangular Platter 10-1/8" x 7"	Case	24-Pcs
Q	WDP017-112	Rectangular Platter 11-7/8" x 8"	Case	12-Pcs
R	WDP017-113	Rectangular Platter 13-7/8" x 9-1/4"	Case	12-Pcs
S	WDP017-114	Rectangular Platter 15-5/8" x 10-5/8"	Case	12-Pcs



**EDESSA™** *Traditional Charm*  
Bright White Porcelain

ITEM	DESCRIPTION	SIZE	UOM	QTY/CASE
T	WDP018-101	Square Dish 4-1/4" Sq	Case	36-Pcs
U	WDP018-102	Round Dish 6-5/8" Dia	Case	36-Pcs
V	WDP018-103	Round Dish 8-3/4" Dia	Case	24-Pcs
W	WDP018-104	Round Dish 11" Dia	Case	12-Pcs



**LERA™** *Engaging Curves*  
Bright White Porcelain

ITEM	DESCRIPTION	SIZE	UOM	QTY/CASE
X	WDP013-101	Square Bowl, Deep 8-1/4" Sq	Case	12-Pcs
Y	WDP013-102	Square Dish 4-1/4" Sq	Case	36-Pcs
Z	WDP013-103	Square Dish 5-1/4" Sq	Case	36-Pcs
AA	WDP013-104	Square Dish 6" Sq	Case	36-Pcs



**KESTER™** *The Casual Frame*  
Bright White Porcelain

ITEM	DESCRIPTION	SIZE	UOM	QTY/CASE
BB	WDP020-101	Square Bowl 5-1/2" Sq	Case	36-Pcs





Mix and Match

# MESCALORE™

Bright White Porcelain

ITEM	DESCRIPTION	SIZE	CAPACITY	UOM	QTY/CASE
A	Handle Dish, Mini	2-1/2" Dia	1.1 Oz	Case	36-Pcs
B	Triangle Bowl	3-7/8"	3 Oz	Case	36-Pcs
C	Teardrop Dish	3-3/4" Dia	3 Oz	Case	36-Pcs
D	Square Bowl, Mini	2-1/2"	1.5 Oz	Case	36-Pcs
E	Square Bowl, Small	3-1/8"	3 Oz	Case	36-Pcs
F	Rectangle Dish, Mini	4-1/2" x 2-7/8"	3 Oz	Case	36-Pcs
G	Rectangle Dish, Sml	5-1/4" x 3-7/8"	4 Oz	Case	36-Pcs
H	Angled Oval Dish	4" x 2-1/2"	3 Oz	Case	36-Pcs
I	Trio Tray	13-3/4" x 5"		Case	24-Pcs
J	Sauce Boat, Mini	3" Dia x 2"H	3 Oz	Case	36-Pcs
K	Long Plate, Mini	5-1/2" x 2-1/2"		Case	36-Pcs
L	Long Plate, Small	8-1/8" x 3-1/8"		Case	36-Pcs
M	Long Plate, Med	9-3/8" x 3-1/2"		Case	36-Pcs
N	Long Plate, Large	10-3/8" x 4"		Case	36-Pcs



# TENORA™ The Stylist Café

Bright White Porcelain

ITEM	DESCRIPTION	SIZE	UOM	QTY/CASE
O	WDP012-101 Tray	8" x 3-3/4"	Case	36-Pcs
P	WDP012-102 Tray	10-1/2" x 5"	Case	24-Pcs



A Memorable Finish **NEWRY™**

Bright White Porcelain

ARDESIA™ PORCELAIN

ITEM	DESCRIPTION	SIZE	CAPACITY	UOM	QTY/CASE
Q	WDP016-101 Trio Tapas Set	12" x 3-1/2"	5 Oz Ea	Case	12-Sets
R	WDP016-102 Quartet Tapas Set	9-3/4" x 6-3/4"	5 Oz Ea	Case	12-Sets
S	WDP016-103 Soup/Sandwich Set	11-5/8" x 4-3/4"	9 Oz	Case	12-Sets
T	WDP015-102 Trio Bowl Set w/ Wooden Plate	9-3/8" x 4"	3 Oz Ea	Case	24-Sets
U	WDP015-103 Trio Bowl Set w/ Wooden Plate	11-5/8" x 3-1/8"	2 Oz Ea	Case	24-Sets
V	WDP015-104 Trio Bowl Set w/ Wooden Plate	15-1/4" x 4-1/8"	4.5 Oz Ea	Case	12-Sets
W	WDP014-101 Trio Set w/Stand	15" x 3-3/4"	8 Oz Ea	Case	12-Sets
X	WDP014-102 Trio Set w/Stand	16-1/2" x 4-5/8"	9 Oz Ea	Case	12-Sets



Q



R



S



T



U



V



W



X

**MELAMINE**

The Ardesia™ by Winco® melamine collections bring a level of elegance, as well as strength and durability to your table settings. Melamine is virtually break-resistant, making it an ideal alternative to ceramics and the designated choice for high-volume, everyday use. Available in a variety of colors and textures, shapes and sizes, Ardesia™ by Winco® has the look of ceramics with the solidity of melamine, and a style to fit any environment.

A Touch of Earth Tone

**AVA™**

Melamine

ITEM	DESCRIPTION	SIZE	CAPACITY	UOM	QTY/CASE
WDM020-401	Round Plate	9" Dia		Case	24-Pcs
WDM020-402	Round Plate	11" Dia		Case	24-Pcs
WDM020-403	Rimless Bowl	6-1/8" Dia	16 Oz	Case	24-Pcs



WDM020-401



WDM020-402



WDM020-403



ITEM	DESCRIPTION	COLOR	SIZE	CAPACITY	UOM	QTY/CASE
WDM001-401	Hammered Plate	Blue	9" Dia		Case	24-Pcs
WDM001-501	Hammered Plate	Red	9" Dia		Case	24-Pcs
WDM001-601	Hammered Plate	Yellow	9" Dia		Case	24-Pcs
WDM001-402	Hammered Plate	Blue	11" Dia		Case	24-Pcs
WDM001-502	Hammered Plate	Red	11" Dia		Case	24-Pcs
WDM001-602	Hammered Plate	Yellow	11" Dia		Case	24-Pcs
WDM001-405	Hammered Plate	Blue	9-5/8" Dia		Case	24-Pcs
WDM001-505	Hammered Plate	Red	9-5/8" Dia		Case	24-Pcs
WDM001-605	Hammered Plate	Yellow	9-5/8" Dia		Case	24-Pcs
WDM001-406	Hammered Bowl	Blue	7-1/2" Dia	0.8 Qt	Case	24-Pcs
WDM001-506	Hammered Bowl	Red	7-1/2" Dia	0.8 Qt	Case	24-Pcs
WDM001-606	Hammered Bowl	Yellow	7-1/2" Dia	0.8 Qt	Case	24-Pcs
WDM001-407	Hammered Bowl	Blue	13-3/4" Dia	3 Qt	Case	12-Pcs
WDM001-507	Hammered Bowl	Red	13-3/4" Dia	3 Qt	Case	12-Pcs
WDM001-607	Hammered Bowl	Yellow	13-3/4" Dia	3 Qt	Case	12-Pcs
WDM001-408	Rectangular Plate	Blue	19" x 8"	0.8 Qt	Case	24-Pcs
WDM001-508	Rectangular Plate	Red	19" x 8"	0.8 Qt	Case	24-Pcs
WDM001-608	Rectangular Plate	Yellow	19" x 8"	0.8 Qt	Case	24-Pcs



WDM001-406  
WDM001-506  
WDM001-606

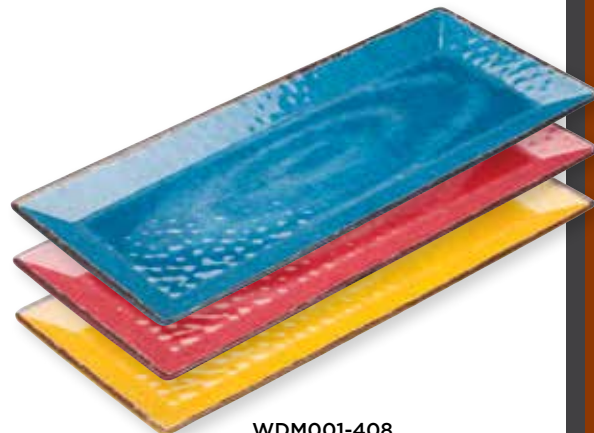

WDM001-408  
WDM001-508  
WDM001-608



WDM001-407  
WDM001-507  
WDM001-607



WDM001-401  
WDM001-501  
WDM001-601



WDM001-402  
WDM001-502  
WDM001-602



WDM001-405  
WDM001-505  
WDM001-605



The Salsa Dish  
**MILA™**  
 Melamine



ITEM	DESCRIPTION	COLOR	CAPACITY	UOM	QTY/CASE
WDM008-401	Salsa Plate	Blue	4 Oz	Case	48-Pcs
WDM008-402	Salsa Plate	Blue	5 Oz	Case	48-Pcs
WDM008-501	Salsa Plate	Brown	4 Oz	Case	48-Pcs
WDM008-502	Salsa Plate	Brown	5 Oz	Case	48-Pcs



WDM008-401



WDM008-501



WDM008-402



WDM008-502



For the Dipper

**HARUKI™**  
 Melamine



ITEM	DESCRIPTION	SIZE	CAPACITY	UOM	QTY/CASE
WDM017-301	Square Bowl	2-5/8"	2 Oz	Case	48-Pcs
WDM017-302	Round Bowl	4" Dia	4.5 Oz	Case	48-Pcs



WDM017-301 2-5/8"



WDM017-302 4"DIA

ITEM	DESCRIPTION	SIZE	UOM	QTY/CASE
WDM011-301	Rectangular Plate	8-1/2" x 4-1/2"	Case	24-Pcs
WDM011-302	Rectangular Plate	10-1/2" x 5-1/4"	Case	24-Pcs



WDM011-301



WDM011-302



The Tides  
**MIYU™**  
Melamine

ITEM	DESCRIPTION	SIZE	UOM	QTY/CASE
WDM016-301	Rectangular Plate	11-3/8" x 5-1/2"	Case	24-Pcs
WDM016-302	Rectangular Plate	10-1/2" x 4-1/2 1/4"	Case	24-Pcs



WDM016-302



WDM016-301



The Irregular  
**KONNO™**  
Melamine

ITEM	DESCRIPTION	SIZE	UOM	QTY/CASE
WDM015-301	Triangular Plate	8-1/8"	Case	24-Pcs
WDM015-302	Triangular Plate	9"	Case	24-Pcs



WDM015-301



WDM015-302



The Matte Trinity  
**NATSUKI™**  
Melamine





Organically Crafted

**KAORI™**  
Melamine

ITEM	DESCRIPTION	SIZE	CAPACITY	UOM	QTY/CASE
WDM019-301	Round Platter	11-1/2" Dia		Case	12-Pcs
WDM019-302	Rectangular Platter 12-1/2" x 5"			Case	24-Pcs
WDM019-303	Rectangular Platter 14-1/2" x 6-3/8"			Case	12-Pcs
WDM019-304	Oval Bowl	8-3/4" x 5-3/4"	8 Oz	Case	24-Pcs
WDM019-305	Rectangular Platter 11-1/2" x 9-1/2"			Case	12-Pcs
WDM019-306	Oval Bowl	9" x 6-5/8"	20 Oz	Case	24-Pcs
WDM019-307	Oval Bowl	10" x 6-1/4"	16 Oz	Case	24-Pcs
WDM019-308	Angled Bowl	9" Dia	23 Oz	Case	12-Pcs
WDM019-309	Angled Bowl	11" Dia	1 Qt	Case	12-Pcs



WDM019-302



WDM019-303



WDM019-304



WDM019-306



WDM019-308



WDM019-309



WDM019-307



WDM019-301



WDM019-305



The Fluidity  
**HIROTO™**  
Melamine

ITEM	DESCRIPTION	SIZE	UOM	QTY/CASE
WDM018-301	Rectangular Plate	7-3/4" x 5"	Case	24-Pcs
WDM018-302	Rectangular Plate	8-3/4" x 5-1/2"	Case	24-Pcs
WDM018-303	Rectangular Plate	10" x 6-1/8"	Case	24-Pcs



WDM018-301



WDM018-302



WDM018-303





ITEM	DESCRIPTION	SIZE	CAPACITY	UOM	QTY/CASE
WDM012-301	Bowl	8" Dia	1 Qt	Case	24-Pcs
WDM012-302	Bowl	9" Dia	1.25 Qt	Case	24-Pcs
WDM012-303	Bowl	10" Dia	1.75 Qt	Case	24-Pcs
WDM012-304	Bowl	11-1/2" Dia	2.75 Qt	Case	12-Pcs
WDM012-305	Bowl	13-1/2" Dia	3.75 Qt	Case	6-Pcs



WDM012-301



WDM012-302



WDM012-303



WDM012-304



WDM012-305



Double Texture  
**KUMATA™**  
Melamine

ITEM	DESCRIPTION	SIZE	CAPACITY	UOM	QTY/CASE
WDM014-301	Bowl	5-3/8" Dia	10 Oz	Case	24-Pcs
WDM014-302	Bowl	6-7/8" Dia	22 Oz	Case	24-Pcs
WDM014-303	Bowl	8" Dia	1 Qt	Case	24-Pcs
WDM014-304	Bowl	9" Dia	1.5 Qt	Case	24-Pcs



WDM014-301



WDM014-302



WDM014-303



WDM014-304



The Stacked Coils  
**TOGASHI™**  
Melamine

The Concentric Rings

**RIKA™**  
Melamine

ITEM	DESCRIPTION	SIZE	UOM	QTY/CASE
WDM013-301	Square Plate	8-3/4"	Case	24-Pcs
WDM013-302	Square Plate	9-3/4"	Case	24-Pcs
WDM013-303	Square Plate	10-3/4"	Case	24-Pcs
WDM013-304	Square Plate	11-3/4"	Case	24-Pcs
WDM013-305	Square Plate	12-3/4"	Case	12-Pcs
WDM013-306	Square Plate	13-3/4"	Case	12-Pcs



WDM013-301

WDM013-302

WDM013-303



WDM013-304

WDM013-305

WDM013-306

ITEM	DESCRIPTION	COLOR	SIZE	CAPACITY	UOM	QTY/CASE
WDM009-201	Square Bowl	White	2-1/2"	2 Oz	Case	48-Pcs
WDM009-202	Square Bowl	White	3-1/2"	5 Oz	Case	48-Pcs
WDM009-203	Square Bowl	White	5"	17 Oz	Case	24-Pcs
WDM009-204	Square Bowl	White	7-1/2"	1.75 Qt	Case	12-Pcs
WDM009-205	Square Bowl	White	10"	5 Qt	Case	6-Pcs
WDM009-301	Square Bowl	Black	2-1/2"	2 Oz	Case	48-Pcs
WDM009-302	Square Bowl	Black	3-1/2"	5 Oz	Case	48-Pcs
WDM009-303	Square Bowl	Black	5"	17 Oz	Case	24-Pcs
WDM009-304	Square Bowl	Black	7-1/2"	1.75 Qt	Case	12-Pcs
WDM009-305	Square Bowl	Black	10"	5 Qt	Case	6-Pcs

The Simplicity Element

**LINZA™**  
Melamine



WDM009-201  
WDM009-301

WDM009-202  
WDM009-302

WDM009-203  
WDM009-303



WDM009-204  
WDM009-304

WDM009-205  
WDM009-305

ITEM	DESCRIPTION	SIZE	CAPACITY	UOM	QTY/CASE
WDM005-201	Triangular Bowl	7"	0.75 Qt	Case	24-Pcs
WDM005-202	Triangular Bowl	8"	1 Qt	Case	24-Pcs
WDM005-203	Triangular Bowl	9"	1.25 Qt	Case	24-Pcs
WDM005-204	Triangular Bowl	10"	1.6 Qt	Case	24-Pcs
WDM005-205	Triangular Bowl	11"	2.25 Qt	Case	12-Pcs



WDM005-201

WDM005-202

WDM005-203



WDM005-204

WDM005-205



The Triad  
**ELISTA™**  
Melamine

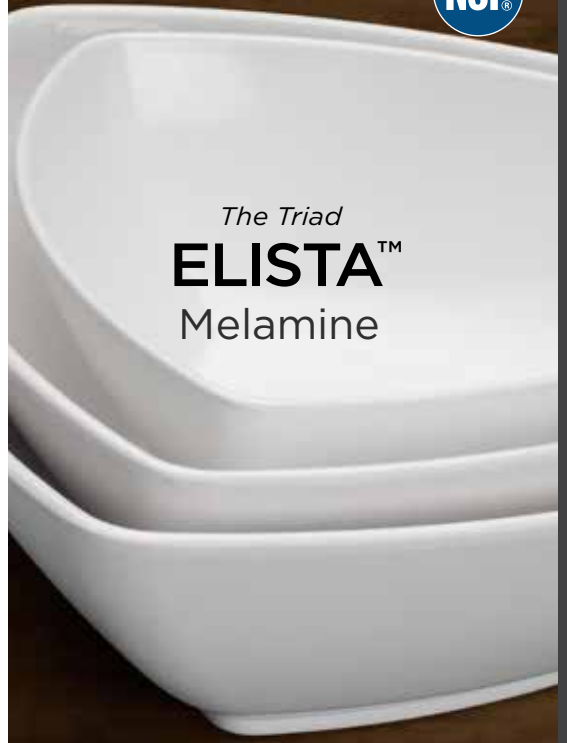

ARDESIA™ MELAMINE

ITEM	DESCRIPTION	SIZE	UOM	QTY/CASE	
WDM003-201	Angled Bowl	12" Dia	1.75 Qt	Case	12-Pcs
WDM003-202	Angled Bowl	14" Dia	2.75 Qt	Case	12-Pcs
WDM003-203	Angled Bowl	16" Dia	4.5 Qt	Case	6-Pcs



WDM003-201

WDM003-202



WDM003-203



The Modern Slant  
**HAILEY™**  
Melamine





The Embossed Spiral  
**SELENA™**  
Melamine

ITEM	DESCRIPTION	SIZE	UOM	QTY/CASE
WDM007-201	Triangular Plate	9"	Case	24-Pcs
WDM007-202	Triangular Plate	11"	Case	24-Pcs
WDM007-203	Triangular Plate	13-1/4"	Case	12-Pcs
WDM007-204	Triangular Plate	15-1/4"	Case	12-Pcs



WDM007-201



WDM007-202



WDM007-203



WDM007-204



The Deep Trumpet  
**PRISCILA™**  
Melamine

ITEM	DESCRIPTION	SIZE	CAPACITY	UOM	QTY/CASE
WDM004-201	Angled Bowl	6-1/2" Dia	0.5 Qt	Case	24-Pcs
WDM004-202	Angled Bowl	7-1/4" Dia	0.75 Qt	Case	24-Pcs
WDM004-203	Angled Bowl	8-1/2" Dia	1 Qt	Case	24-Pcs



WDM004-201



WDM004-202



WDM004-203



ITEM	DESCRIPTION	SIZE	UOM	QTY/CASE
WDM002-401	Rectangular Platter	20-7/8" x 8"	Case	12-Pcs
WDM002-402	Round Platter	11-7/8" Dia	Case	12-Pcs



From Farm to Table  
**SEMONE™**  
Melamine

20-7/8" X 8"

11-7/8" DIA

ITEM	DESCRIPTION	SIZE	CAPACITY	UOM	QTY/CASE
WDM006-201	Trio Plate	16-3/8" x 5-1/2"		Case	24-Pcs
WDM006-202	Trio Bowl	7" Dia	0.5 Qt	Case	24-Pcs



The Contemporary Trio  
**AKILA™**  
Melamine



ITEM	DESCRIPTION	SIZE	CAPACITY	UOM	QTY/CASE
WDM010-301	Mini Pan	6-1/4" Dia	13 Oz	Case	24-Pcs



The Rustic Skillet  
**ARLO™**  
Melamine

**SLATE** The Ardesia™ by Winco® slate collection brings a level of elegance, as well as strength and durability to your table settings.

ITEM	DESCRIPTION	SIZE	UOM	QTY/PACK
WDL001-301	Rectangular Platter	11-1/2" x 4"	Pack	6-Pcs
WDL001-302	Rectangular Platter	11-1/2" x 7-7/8"	Pack	6-Pcs
WDL001-303	Rectangular Platter	15-3/4" x 11-1/2"	Pack	6-Pcs

Straight from the Slate

**TAVO™**  
Slate



WDL001-301



WDL001-302

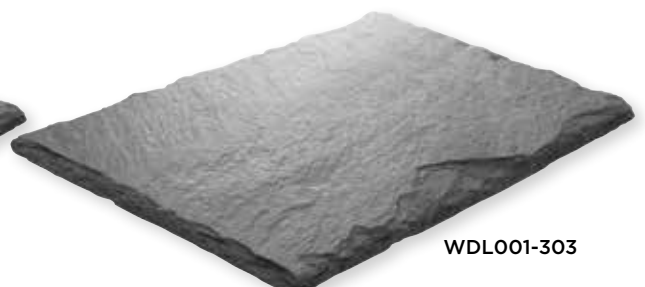

WDL001-303



**CLASSIC MELAMINE** Heat resistant up to 212°F (100°C)



DISHWASHER SAFE



NOT FOR OVEN OR MICROWAVE USE



MMPR-10



MMPR-10W



MMPO-118



MMPO-118W



MMPT-117



MMPT-117W



MMB-22



MMB-22W



MMB-15



MMB-15W



MMB-12



MMB-12W

**ROUND PLATES**

ITEM	SIZE	COLOR	UOM	CASE
MMPR-5	5-1/2" Dia	Tan	Doz	1/8
MMPR-5W	5-1/2" Dia	White	Doz	1/8
MMPR-6	6-1/2" Dia	Tan	Doz	1/4
MMPR-6W	6-1/2" Dia	White	Doz	1/4
MMPR-7	7-1/4" Dia	Tan	Doz	1/8
MMPR-7W	7-1/4" Dia	White	Doz	1/8
MMPR-8	8" Dia	Tan	Doz	1/4
MMPR-8W	8" Dia	White	Doz	1/4
MMPR-9	9" Dia	Tan	Doz	1/4
MMPR-9W	9" Dia	White	Doz	1/4
MMPR-10	10-1/4" Dia	Tan	Doz	1/2
MMPR-10W	10-1/4" Dia	White	Doz	1/2

**OVAL PLATTERS WITH NARROW RIM**

ITEM	SIZE	COLOR	UOM	CASE
MMPO-96	9-3/4"L x 6-3/4"W	Tan	Doz	1/2
MMPO-96W	9-3/4"L x 6-3/4"W	White	Doz	1/2
MMPO-118	11-1/2"L x 8"W	Tan	Doz	1/2
MMPO-118W	11-1/2"L x 8"W	White	Doz	1/2
MMPO-138	13"L x 8"W	Tan	Doz	1/2
MMPO-138W	13"L x 8"W	White	Doz	1/2
MMPO-139	13-1/4"L x 9-5/8"W	Tan	Doz	1/4
MMPO-139W	13-1/4"L x 9-5/8"W	White	Doz	1/4
MMPO-1510	15-1/2"L x 10-7/8"W	Tan	Doz	1/2
MMPO-1510W	15-1/2"L x 10-7/8"W	White	Doz	1/2

**RECTANGULAR PLATTERS**

ITEM	SIZE	COLOR	UOM	CASE
MMPT-96	9-1/2"L x 6-3/4"W	Tan	Doz	1/4
MMPT-96W	9-1/2"L x 6-3/4"W	White	Doz	1/4
MMPT-117	11-1/2"L x 7-1/2"W	Tan	Doz	1/4
MMPT-117W	11-1/2"L x 7-1/2"W	White	Doz	1/4
MMPT-129	12-1/2"L x 9"W	Tan	Doz	1/2
MMPT-129W	12-1/2"L x 9"W	White	Doz	1/2
MMPT-1510	15"L x 10-5/8"W	Tan	Doz	1/2
MMPT-1510W	15"L x 10-5/8"W	White	Doz	1/2

**RIMLESS BOWLS**

ITEM	SIZE	CAPACITY	COLOR	UOM	CASE
MMB-22	6-7/8" Dia	22 oz	Tan	Doz	1/2
MMB-22W	6-7/8" Dia	22 oz	White	Doz	1/2
MMB-32	7-1/2" Dia	32 oz	Tan	Doz	1/4
MMB-32W	7-1/2" Dia	32 oz	White	Doz	1/4
MMB-41	8" Dia	41 oz	Tan	Doz	1/4
MMB-41W	8" Dia	41 oz	White	Doz	1/4
MMB-52	8-3/4" Dia	52 oz	Tan	Doz	1/4
MMB-52W	8-3/4" Dia	52 oz	White	Doz	1/4
MMB-70	9-3/4" Dia	70 oz	Tan	Doz	1/2
MMB-70W	9-3/4" Dia	70 oz	White	Doz	1/2
MMB-96	11" Dia	96 oz	Tan	Doz	1/2
MMB-96W	11" Dia	96 oz	White	Doz	1/2

**NAPPIES**

ITEM	SIZE	CAPACITY	COLOR	UOM	CASE
MMB-11	4-7/8" Dia	11 oz	Tan	Doz	1/8
MMB-11W	4-7/8" Dia	11 oz	White	Doz	1/8
MMB-15	5-1/4" Dia	15 oz	Tan	Doz	1/8
MMB-15W	5-1/4" Dia	15 oz	White	Doz	1/8

**SOUP/CEREAL BOWLS**

ITEM	SIZE	CAPACITY	COLOR	UOM	CASE
MMB-12	6-3/8" Dia	12 oz	Tan	Doz	1/8
MMB-12W	6-3/8" Dia	12 oz	White	Doz	1/8



MELAMINE COLLECTION

 **SAUCE CUPS/RAMEKINS**

ITEM	SIZE	CAPACITY	COLOR	UOM	CASE
MMSC-2	2-7/8" Dia	2-1/2 oz	Tan	Doz	1/24
MMSC-2W	2-7/8" Dia	2-1/2 oz	White	Doz	1/24
MMSC-4	3-1/4" Dia	4 oz	Tan	Doz	1/12
MMSC-4W	3-1/4" Dia	4 oz	White	Doz	1/12



MMSC-2



MMSC-2W

 **BOUILLON CUPS**

ITEM	SIZE	CAPACITY	COLOR	UOM	CASE
MMB-8	3-7/8" Dia	8 oz	Tan	Doz	1/4
MMB-8W	3-7/8" Dia	8 oz	White	Doz	1/4



MMB-8



MMB-8W

 **FRUIT BOWLS**

ITEM	SIZE	CAPACITY	COLOR	UOM	CASE
MMB-4	4-3/4" Dia	4 oz	Tan	Doz	1/8
MMB-4W	4-3/4" Dia	4 oz	White	Doz	1/8
MMB-5	4-3/4" Dia	5 oz	Tan	Doz	1/4
MMB-5W	4-3/4" Dia	5 oz	White	Doz	1/4



MMB-4



MMB-5W

 **GRAPEFRUIT BOWLS**

ITEM	SIZE	CAPACITY	COLOR	UOM	CASE
MMB-10	5-1/2" Dia	10 oz	Tan	Doz	1/8
MMB-10W	5-1/2" Dia	10 oz	White	Doz	1/8
MMB-13	5-3/4" Dia	13 oz	Tan	Doz	1/4
MMB-13W	5-3/4" Dia	13 oz	White	Doz	1/4



MMB-13



MMB-13W

 **BULBOUS MUGS**

◆ 3-1/2"L x 2-15/16"W/Dia x 3-5/8"H

ITEM	SIZE	CAPACITY	COLOR	UOM	CASE
MMU-8	2-15/16" Dia	8oz	Tan	Doz	1/4
MMU-8W	2-15/16" Dia	8oz	White	Doz	1/4



MMU-8



MMU-8W

 **RAMEKIN CUPS**

◆ Available fluted or plain; black, bone &amp; white colors

ITEM	DESCRIPTION	SIZE	COLOR	UOM	CASE
RFM-1K	Fluted	1-1/2 Oz	Black	Doz	1/8
RFM-1W	Fluted	1-1/2 Oz	White	Doz	1/8
RFM-1B	Fluted	1-1/2 Oz	Bone	Doz	1/8
RFM-2K	Fluted	2 Oz	Black	Doz	1/8
RFM-2W	Fluted	2 Oz	White	Doz	1/8
RFM-2B	Fluted	2 Oz	Bone	Doz	1/8
RFM-3K	Fluted	3 Oz	Black	Doz	1/8
RFM-3W	Fluted	3 Oz	White	Doz	1/8
RFM-3B	Fluted	3 Oz	Bone	Doz	1/8
RFM-4K	Fluted	4 Oz	Black	Doz	1/8
RFM-4W	Fluted	4 Oz	White	Doz	1/8
RFM-4B	Fluted	4 Oz	Bone	Doz	1/8
RP-1K	Plain	1-1/2 Oz	Black	Doz	1/8
RP-1W	Plain	1-1/2 Oz	White	Doz	1/8
RP-1B	Plain	1-1/2 Oz	Bone	Doz	1/8
RP-2K	Plain	2 Oz	Black	Doz	1/8
RP-2W	Plain	2 Oz	White	Doz	1/8
RP-2B	Plain	2 Oz	Bone	Doz	1/8
RP-3K	Plain	3 Oz	Black	Doz	1/8
RP-3W	Plain	3 Oz	White	Doz	1/8
RP-3B	Plain	3 Oz	Bone	Doz	1/8
RP-4K	Plain	4 Oz	Black	Doz	1/8
RP-4W	Plain	4 Oz	White	Doz	1/8
RP-4B	Plain	4 Oz	Bone	Doz	1/8
RP-6K	Plain	6 Oz	Black	Doz	1/8
RP-6W	Plain	6 Oz	White	Doz	1/8
RP-6B	Plain	6 Oz	Bone	Doz	1/8



FLUTED RFM-SERIES



PLAIN RP-SERIES



BLACK

WHITE

BONE

MELAMINE COLLECTION

# Monte Carlo



ITEM	DESCRIPTION	UOM	CASE
Z-MC-C05	Monte Carlo Creamer, 5 oz, 0.2 lbs	Each	6/72
Z-MC-TP10	Monte Carlo Tea Pot, 10 oz, 0.4 lbs	Each	6/72
Z-MC-CP64	Monte Carlo Coffee Server, 64 oz, 1.2 lbs	Each	6/12
Z-MC-WP64	Monte Carlo Water Pitcher (Ice Guard), 64 oz, 1.6 lbs	Each	6/12

Sleek and sophisticated, the Monte Carlo hollowware line features clean and fluid contours in brilliantly polished 18/10 stainless steel mirror finish, offering strength, durability, and striking beauty in all cosmopolitan dining settings.



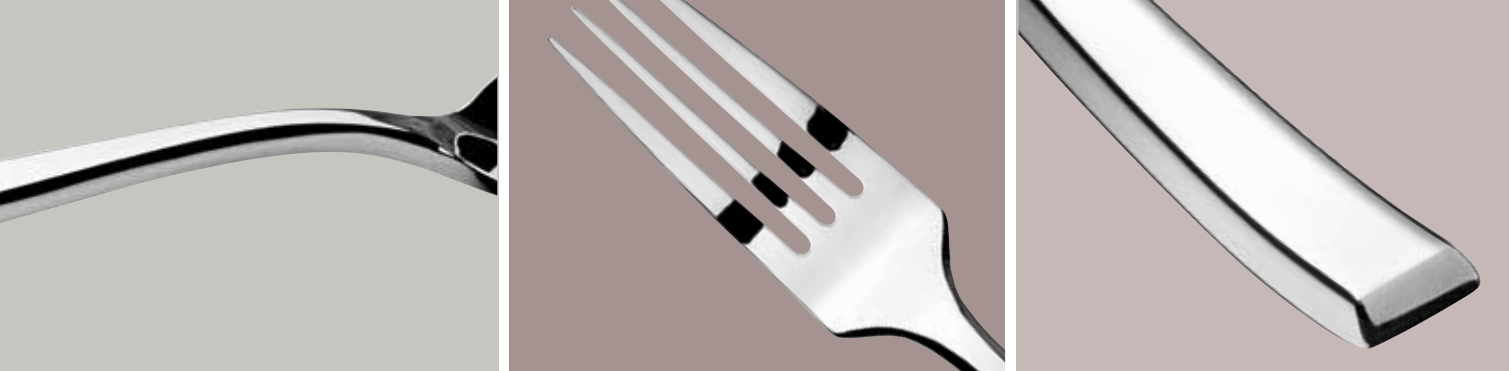

# Isola



ITEM	DESCRIPTION	UOM	CASE
Z-IS-01	Isola Teaspoon, 6"L, 3.7mm	Doz	1/15
Z-IS-03	Isola Dinner Spoon, 8-3/16"L, 5.0mm	Doz	1/15
Z-IS-04	Isola Boullion Spoon, 7-3/16"L, 5.0mm	Doz	1/15
Z-IS-05	Isola Dinner Fork, 8"L, 5.0mm	Doz	1/15
Z-IS-06	Isola Salad Fork, 7-1/2"L, 4.0mm	Doz	1/15
Z-IS-08	Isola Dinner Knife (Solid), 9-1/2"L, 8.5mm	Doz	1/15

Inspired by the flawless symmetry of the gardens of Isola Bella, the solid, angular design and distinct lines of this sleek pattern are versatile enough to complete a Champagne brunch or add polish to upscale dining presentations.



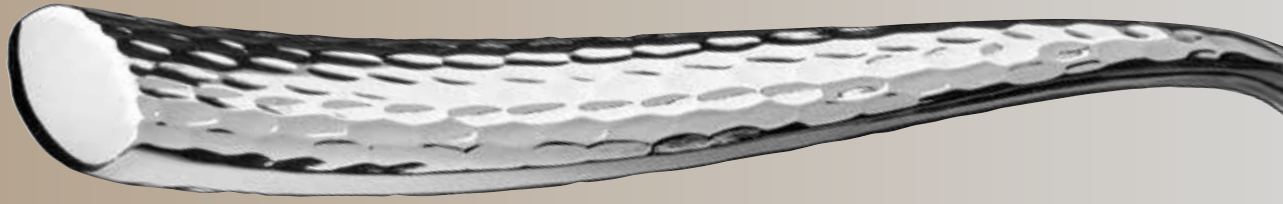

# Ampezzo



ITEM	DESCRIPTION	UOM	CASE
Z-AZ-01	Ampezzo Teaspoon, 6"L, 3.0mm	Doz	1/15
Z-AZ-03	Ampezzo Dinner Spoon, 7-11/16"L, 5.2mm	Doz	1/15
Z-AZ-05	Ampezzo Dinner Fork, 8-1/8"L, 4.5mm	Doz	1/15
Z-AZ-06	Ampezzo Salad Fork, 7-1/2"L, 5.2mm	Doz	1/15
Z-AZ-08	Ampezzo Dinner Knife (Solid), 9-1/2"L, 9.0mm	Doz	1/15

Guaranteed to be a sophisticated standout, the heavy weight and multi-faceted design of this pattern draws its inspiration from the mountain range town of Cortina d'Ampezzo and adds a unique and decorative touch to any dinner table setting.



## Claret



ITEM	DESCRIPTION	UOM	CASE
Z-CL-01	Claret Teaspoon, 6"L, 3.5mm	Doz	1/15
Z-CL-03	Claret Dinner Spoon, 7-13/16"L, 4.0mm	Doz	1/15
Z-CL-05	Claret Dinner Fork, 8-1/8"L, 4.0mm	Doz	1/15
Z-CL-06	Claret Salad Fork, 7-11/16"L, 3.5mm	Doz	1/15
Z-CL-08	Claret Dinner Knife (Hollow), 9-7/16"L, 8.5mm	Doz	1/15

The exceptional weight and modernity formed by the smooth contours and beautiful quality of the simple yet sophisticated, solid Claret pattern sparkle like a tranquil lake, offering a timeless appeal and a bright finish that blends with any white linen dining table décor.



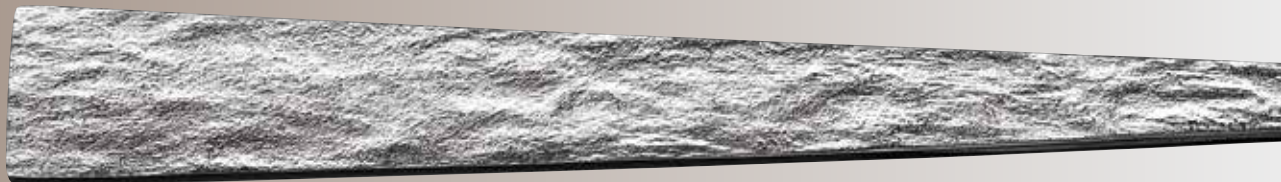

# Carrera



ITEM	DESCRIPTION	UOM	CASE
Z-CR-01	Carrera Teaspoon, 6"L, 3.0mm	Doz	1/15
Z-CR-03	Carrera Dinner Spoon, 7-11/16"L, 3.5mm	Doz	1/15
Z-CR-05	Carrera Dinner Fork, 8-1/4"L, 3.5mm	Doz	1/15
Z-CR-06	Carrera Salad Fork, 7-3/16"L, 3.5mm	Doz	1/15
Z-CR-08	Carrera Dinner Knife (Solid), 9-3/8"L, 8.0mm	Doz	1/15

Inspired by the enduring nature of stone and marble, Carrera adds an element of distinct textural beauty, offering a substantial presence to modern, rustic table settings and making a stylish statement for any dining occasion.





# Aires



ITEM	DESCRIPTION	UOM	CASE
Z-AR-01	Aires Teaspoon, 6"L, 4.2mm	Doz	1/15
Z-AR-03	Aires Dinner Spoon, 8-1/8"L, 5.2mm	Doz	1/15
Z-AR-05	Aires Dinner Fork, 8-1/8"L, 5.5mm	Doz	1/15
Z-AR-06	Aires Salad Fork, 7"L, 4.5mm	Doz	1/15
Z-AR-08	Aires Dinner Knife (Solid), 9-7/16"L, 9.5mm	Doz	1/15

Teardrop-shaped spoon bowls and delicately sculpted lines with exquisite slender handle proportions that command a maestro's touch, the Aires pattern provides a charming, modest sleekness that is perfect for formal or casual affairs.

# SHANGARILA



*With simple and elegant contoured lines, the Shangarila pattern brings an understated sophistication to any setting.*

- ◆ 18/8 stainless steel
- ◆ Extra heavyweight
- ◆ Mirror finish
- ◆ 3.0mm thickness  
dinner fork and spoon



SEE PAGE 62 FOR  
COORDINATING  
SHANGARILA  
SERVING PIECES

ITEM	DESCRIPTION	LENGTH	UOM	CASE
0030-01	Teaspoon	6"	Doz	1/25
0030-02	Iced Tea Spoon	7-3/8"	Doz	1/25
0030-03	Dinner Spoon	7-1/4"	Doz	1/25
0030-04	Bouillon Spoon	5-7/8"	Doz	1/25
0030-05	Dinner Fork	7-1/4"	Doz	1/25
0030-06	Salad Fork	6-3/4"	Doz	1/25
0030-07	Oyster Fork	5-11/16"	Doz	1/25
0030-08	Dinner Knife	9-1/4"	Doz	1/15
0030-09	Demitasse Spoon	4-5/8"	Doz	1/25
0030-10	Tablespoon (Euro Length)	8-1/4"	Doz	1/25
0030-11	Table Fork (Euro Length)	8"	Doz	1/25
0030-12	Butter Spreader	6-3/4"	Doz	1/25
0030-15	Hollow Handle Table Knife	9-1/4"	Doz	1/15
0030-16	Steak Knife Pointed Tip	8-7/8"	Doz	1/15
0030-18	European Table Knife	9-3/4"	Doz	1/15
0030-19	Salad Knife	8-7/16"	Doz	1/15



# PEACOCK



*Like its namesake, the sculpted detail of the Peacock pattern blends seamlessly into any elaborate setting.*

- ◆ 18/8 stainless steel
- ◆ Extra heavyweight
- ◆ Mirror finish
- ◆ 3.0mm thickness  
dinner fork and spoon

ITEM	DESCRIPTION	LENGTH	UOM	CASE
0031-01	Teaspoon	6-1/8"	Doz	1/25
0031-02	Iced Tea Spoon	7-13/16"	Doz	1/25
0031-03	Dinner Spoon	7-9/16"	Doz	1/25
0031-04	Bouillon Spoon	6"	Doz	1/25
0031-05	Dinner Fork	7-13/16"	Doz	1/25
0031-06	Salad Fork	6-3/4"	Doz	1/25
0031-07	Oyster Fork	5-3/4"	Doz	1/25
0031-08	Dinner Knife	8-7/8"	Doz	1/15
0031-09	Demitasse Spoon	4-1/2"	Doz	1/25
0031-10	Tablespoon (Euro Length)	8-3/8"	Doz	1/25
0031-11	Table Fork (Euro Length)	8"	Doz	1/25
0031-12	Butter Spreader	6-3/4"	Doz	1/25
0031-18	European Table Knife	9-5/8"	Doz	1/15

# CHANTELLE



*Inspired by the Regency era, the delicate flourished lines of the Chantelle pattern add a traditional touch to any setting.*

- ◆ 18/8 stainless steel
- ◆ Extra heavyweight
- ◆ Mirror finish
- ◆ 3.0mm thickness  
dinner fork and spoon

ITEM	DESCRIPTION	LENGTH	UOM	CASE
0039-01	Teaspoon	6"	Doz	1/25
0039-02	Iced Tea Spoon	7-1/2"	Doz	1/25
0039-03	Dinner Spoon	7-1/4"	Doz	1/25
0039-04	Bouillon Spoon	5-7/8"	Doz	1/25
0039-05	Dinner Fork	7-1/4"	Doz	1/25
0039-06	Salad Fork	6-1/4"	Doz	1/25
0039-07	Oyster Fork	5-5/8"	Doz	1/25
0039-08	Dinner Knife	9-5/16"	Doz	1/15
0039-09	Demitasse Spoon	4-5/8"	Doz	1/25
0039-10	Tablespoon (Euro Length)	8-1/2"	Doz	1/25
0039-11	Table Fork (Euro Length)	8-1/8"	Doz	1/25
0039-12	Butter Spreader	6-3/4"	Doz	1/25





*Inspired by the water of the floating city, the smooth surface of the Venice pattern brings an understated elegance to any contemporary setting.*

- ◆ 18/8 stainless steel
- ◆ Extra heavyweight
- ◆ Mirror finish
- ◆ 3.0mm thickness dinner fork and spoon

ITEM	DESCRIPTION	LENGTH	UOM	CASE
0037-01	Teaspoon	6-1/8"	Doz	1/25
0037-02	Iced Tea Spoon	7-1/4"	Doz	1/25
0037-03	Dinner Spoon	7-3/8"	Doz	1/25
0037-04	Bouillon Spoon	6-1/4"	Doz	1/25
0037-05	Dinner Fork	7-3/8"	Doz	1/25
0037-06	Salad Fork	6-3/4"	Doz	1/25
0037-07	Oyster Fork	5-5/8"	Doz	1/25
0037-08	Dinner Knife	9-1/8"	Doz	1/15
0037-09	Demitasse Spoon	4-1/2"	Doz	1/25
0037-10	Tablespoon (Euro Length)	8-1/4"	Doz	1/25
0037-11	Table Fork (Euro Length)	8-3/8"	Doz	1/25
0037-12	Butter Spreader	6-3/4"	Doz	1/25

# DELUXE PEARL



*Like a strand of pearls, the delicate beading detail of the Deluxe Pearl pattern is a timeless classic that will enhance any setting.*

- ◆ 18/8 stainless steel
- ◆ Extra heavyweight
- ◆ Mirror finish
- ◆ 3.0mm thickness  
dinner fork and spoon

ITEM	DESCRIPTION	LENGTH	UOM	CASE
0036-01	Teaspoon	6"	Doz	1/25
0036-02	Iced Tea Spoon	7-1/8"	Doz	1/25
0036-03	Dinner Spoon	7-1/4"	Doz	1/25
0036-04	Bouillon Spoon	5-7/8"	Doz	1/25
0036-05	Dinner Fork	7-1/4"	Doz	1/25
0036-06	Salad Fork	7"	Doz	1/25
0036-07	Oyster Fork	5-3/8"	Doz	1/25
0036-08	Dinner Knife	9"	Doz	1/15
0036-09	Demitasse Spoon	4-1/4"	Doz	1/25
0036-10	Tablespoon (Euro Length)	8-1/8"	Doz	1/25
0036-11	Table Fork (Euro Length)	8-1/8"	Doz	1/25
0036-12	Butter Spreader	6-3/4"	Doz	1/25
0036-16	Salad Knife	8-3/8"	Doz	1/25



# STANFORD



*With a subtle elevated fold down the center of a teardrop-shaped handle, the Stanford pattern brings an elegant touch to a contemporary setting.*

- ◆ 18/8 stainless steel
- ◆ Extra heavyweight
- ◆ Mirror finish
- ◆ 3.0mm thickness dinner fork and spoon

ITEM	DESCRIPTION	LENGTH	UOM	CASE
0034-01	Teaspoon	6"	Doz	1/25
0034-02	Iced Tea Spoon	7-5/16"	Doz	1/25
0034-03	Dinner Spoon	7-1/8"	Doz	1/25
0034-04	Bouillon Spoon	6-15/16"	Doz	1/25
0034-05	Dinner Fork	7-1/8"	Doz	1/25
0034-051	Dinner Fork, Extended Length	7-1/4"	Doz	1/25
0034-06	Salad Fork	5-7/8"	Doz	1/25
0034-061	Salad Fork, Extended Length	6-7/8"	Doz	1/25
0034-07	Oyster Fork	5-7/16"	Doz	1/25
0034-08	Dinner Knife	9"	Doz	1/15
0034-09	Demitasse Spoon	4-3/8"	Doz	1/25
0034-10	Tablespoon (Euro Length)	8-5/8"	Doz	1/25
0034-11	Table Fork (Euro Length)	8-1/4"	Doz	1/25
0034-12	Butter Spreader	6-5/8"	Doz	1/25
0034-15	Hollow Handle Dinner Knife	8-3/4"	Doz	1/15
0034-18	Hollow Handle Table Knife	9-5/8"	Doz	1/15

# VICTORIA



*The simple aristocratic lines of the Victoria pattern make it an ideal choice for a formal setting.*

- ◆ 18/8 stainless steel
- ◆ Extra heavyweight
- ◆ Mirror finish
- ◆ 3.0mm thickness  
dinner fork and spoon

ITEM	DESCRIPTION	LENGTH	UOM	CASE
0035-01	Teaspoon	6"	Doz	1/25
0035-02	Iced Tea Spoon	7-1/2"	Doz	1/25
0035-03	Dinner Spoon	7-3/8"	Doz	1/25
0035-04	Bouillon Spoon	5-7/8"	Doz	1/25
0035-05	Dinner Fork	7-1/4"	Doz	1/25
0035-06	Salad Fork	6-7/8"	Doz	1/25
0035-07	Oyster Fork	5-9/16"	Doz	1/25
0035-08	Dinner Knife	9-1/4"	Doz	1/15
0035-09	Demitasse Spoon	4-3/8"	Doz	1/25
0035-10	Tablespoon (Euro Length)	8-1/4"	Doz	1/25
0035-11	Table Fork (Euro Length)	8-1/4"	Doz	1/25
0035-12	Butter Spreader	6-3/4"	Doz	1/25
0035-16	Salad Knife	8-1/2"	Doz	1/25



# OXFORD



*The dignified outline on the fiddle-shaped handle of the Oxford pattern lends a touch of old-fashioned elegance to a setting.*

- ◆ 18/8 stainless steel
- ◆ Extra heavyweight
- ◆ Mirror finish
- ◆ 3.0mm thickness dinner fork and spoon

ITEM	DESCRIPTION	LENGTH	UOM	CASE
0033-01	Teaspoon	6-1/4"	Doz	1/25
0033-02	Iced Tea Spoon	7-1/2"	Doz	1/25
0033-03	Dinner Spoon	7-3/8"	Doz	1/25
0033-04	Bouillon Spoon	6"	Doz	1/25
0033-05	Dinner Fork	7-5/8"	Doz	1/25
0033-06	Salad Fork	7"	Doz	1/25
0033-07	Oyster Fork	5-5/8"	Doz	1/25
0033-08	Dinner Knife	9-5/8"	Doz	1/15
0033-09	Demitasse Spoon	4-1/2"	Doz	1/25
0033-10	Tablespoon (Euro Length)	8"	Doz	1/25
0033-11	Table Fork (Euro Length)	8-1/8"	Doz	1/25
0033-12	Butter Spreader	7"	Doz	1/25



## CONTINENTAL



The Continental pattern is the moderately priced version of the Shangarila pattern with the same simple contour lines and features.

- ◆ 18/0 stainless steel
- ◆ Extra heavyweight
- ◆ Mirror finish
- ◆ 3.0mm thickness dinner fork and spoon

ITEM	DESCRIPTION	LENGTH	UOM	CASE
0021-01	Teaspoon	6"	Doz	1/25
0021-02	Iced Teaspoon	7-1/2"	Doz	1/25
0021-03	Dinner Spoon	7-1/4"	Doz	1/25
0021-04	Bouillon Spoon	5-7/8"	Doz	1/25
0021-05	Dinner Fork	7-1/4"	Doz	1/25
0021-06	Salad Fork	6-3/4"	Doz	1/25
0021-07	Oyster Fork	5-5/8"	Doz	1/25
0030-08	Dinner Knife	9-1/4"	Doz	1/15
0021-09	Demitasse Spoon	4-1/8"	Doz	1/25
0021-10	Tablespoon (Euro Length)	8-1/4"	Doz	1/25
0021-11	Table Fork (Euro Length)	8"	Doz	1/25

## TOULOUSE



The Toulouse pattern features a fiddle shape handle with a stylish shell motif.

- ◆ 18/0 stainless steel
- ◆ Extra heavyweight
- ◆ Mirror finish
- ◆ 3.0mm thickness dinner fork and spoon

ITEM	DESCRIPTION	LENGTH	UOM	CASE
0006-01	Teaspoon	6-3/8"	Doz	1/25
0006-02	Iced Tea Spoon	7"	Doz	1/25
0006-03	Dinner Spoon	7-3/8"	Doz	1/25
0006-04	Bouillon Spoon	6-3/8"	Doz	1/25
0006-05	Dinner Fork	7-5/8"	Doz	1/25
0006-06	Salad Fork	7"	Doz	1/25
0006-07	Oyster Fork	6"	Doz	1/25
0006-08	Dinner Knife	8-3/4"	Doz	1/25
0006-09	Demitasse Spoon	4-5/8"	Doz	1/25
0006-10	Tablespoon	8-1/4"	Doz	1/25
0006-12	Butter Spreader	7-1/16"	Doz	1/25



The Dots pattern features simple lines and elegant beading details around the handle and neck.

- ◆ 18/0 stainless steel
- ◆ Heavyweight
- ◆ Mirror finish

ITEM	DESCRIPTION	LENGTH	UOM	CASE
0005-01	Teaspoon	6-1/4"	Doz	1/50
0005-02	Iced Tea Spoon	7-1/8"	Doz	1/50
0005-03	Dinner Spoon	7-3/8"	Doz	1/50
0005-04	Bouillon Spoon	6-1/8"	Doz	1/50
0005-05	Dinner Fork	7-3/8"	Doz	1/50
0005-06	Salad Fork	6-1/4"	Doz	1/50
0005-07	Oyster Fork	5-5/8"	Doz	1/50
0005-08	Dinner Knife	8-3/4"	Doz	1/25
0005-09	Demitasse Spoon	4-3/4"	Doz	1/50
0005-10	Tablespoon	8-3/8"	Doz	1/25



The Lafayette pattern features a ridged surface with a double scallop accent.

- ◆ 18/0 stainless steel
- ◆ Heavyweight
- ◆ Satin finish

ITEM	DESCRIPTION	LENGTH	UOM	CASE
0015-01	Teaspoon	6"	Doz	1/50
0015-02	Iced Tea Spoon	7-1/4"	Doz	1/50
0015-03	Dinner Spoon	7-1/4"	Doz	1/50
0015-04	Bouillon Spoon	6"	Doz	1/50
0015-05	Dinner Fork	7-5/8"	Doz	1/50
0015-054	Dinner Fork, 4 tines	7-1/2"	Doz	1/50
0015-06	Salad Fork	6-3/4"	Doz	1/50
0015-07	Oyster Fork	5-1/2"	Doz	1/50
0015-08	Dinner Knife	7-3/8"	Doz	1/25
0015-10	Dinner Knife, Hollow Handle	9-1/4"	Doz	1/15
0015-11	Steak Knife, Hollow Handle	9-1/4"	Doz	1/15





The Regency pattern features defined, clean column lines.

- ◆ 18/0 stainless steel
- ◆ Heavyweight
- ◆ Mirror finish

ITEM	DESCRIPTION	LENGTH	UOM	CASE
0007-01	Teaspoon	6"	Doz	1/50
0007-03	Dinner Spoon	7-1/8"	Doz	1/50
0007-04	Bouillon Spoon	5-5/8"	Doz	1/50
0007-05	Dinner Fork	7-3/8"	Doz	1/50
0007-06	Salad Fork	6-1/16"	Doz	1/50
0007-08	Dinner Knife	8-1/2"	Doz	1/25



The Lisa pattern features clean lines and a distinctively raised pitch.

- ◆ 18/0 stainless steel
- ◆ Heavyweight
- ◆ Mirror finish

ITEM	DESCRIPTION	LENGTH	UOM	CASE
0010-01	Teaspoon	6-1/16"	Doz	1/50
0010-03	Dinner Spoon	7-3/4"	Doz	1/50
0010-05	Dinner Fork	7-5/8"	Doz	1/50
0010-08	Dinner Knife	8-1/8"	Doz	1/25



The Winston pattern features a fiddle shaped handle with a smooth finish.

- ◆ 18/0 stainless steel
- ◆ Heavyweight
- ◆ Satin finish

ITEM	DESCRIPTION	LENGTH	UOM	CASE
0016-01	Teaspoon	6-1/8"	Doz	1/50
0016-02	Iced Tea Spoon	7-3/4"	Doz	1/50
0016-03	Dinner Spoon	7-3/8"	Doz	1/50
0016-04	Bouillon Spoon	6-1/8"	Doz	1/50
0016-05	Dinner Fork	7-1/4"	Doz	1/50
0016-06	Salad Fork	6-1/2"	Doz	1/50
0016-08	Dinner Knife	8-3/8"	Doz	1/25



The Manhattan pattern features subtle grooves from the handle neck to the mid-section.

- ◆ 18/0 stainless steel
- ◆ Heavyweight
- ◆ Satin finish

ITEM	DESCRIPTION	LENGTH	UOM	CASE
0008-01	Teaspoon	6-1/8"	Doz	1/50
0008-03	Dinner Spoon	6-3/4"	Doz	1/50
0008-04	Bouillon Spoon	6"	Doz	1/50
0008-05	Dinner Fork	7-1/4"	Doz	1/50
0008-08	Dinner Knife	8-1/8"	Doz	1/25





ELITE

The Elite pattern features a smooth contoured handle with rounded tip.

- ◆ 18/0 stainless steel
- ◆ Heavyweight
- ◆ Mirror finish

ITEM	DESCRIPTION	LENGTH	UOM	CASE
0026-01	Teaspoon	6"	Doz	1/50
0026-03	Dinner Spoon	7"	Doz	1/50
0026-04	Bouillon Spoon	5-7/8"	Doz	1/50
0026-05	Dinner Fork	7-1/8"	Doz	1/50
0026-06	Salad Fork	6-1/8"	Doz	1/50
0026-08	Dinner Knife	8-5/8"	Doz	1/25



FLUTE

The Flute pattern features an elongated oval handle with a smooth finish.

- ◆ 18/0 stainless steel
- ◆ Heavyweight
- ◆ Mirror finish

ITEM	DESCRIPTION	LENGTH	UOM	CASE
0019-01	Teaspoon	5-7/8"	Doz	1/50
0019-03	Dinner Spoon	7-3/16"	Doz	1/50
0019-04	Bouillon Spoon	5-5/8"	Doz	1/50
0019-05	Dinner Fork	7-3/8"	Doz	1/50
0019-06	Salad Fork	6-1/4"	Doz	1/50
0019-08	Dinner Knife	9"	Doz	1/25

The Houston pattern features a fiddle shape handle with a turned out collar at the neck.

- ◆ 18/0 stainless steel
- ◆ Heavyweight
- ◆ Satin finish

ITEM	DESCRIPTION	LENGTH	UOM	CASE
0025-01	Teaspoon	6-1/8"	Doz	1/50
0025-03	Dinner Spoon	7-3/16"	Doz	1/50
0025-04	Bouillon Spoon	6"	Doz	1/50
0025-05	Dinner Fork	7-3/8"	Doz	1/50
0025-06	Salad Fork	6-1/8"	Doz	1/50
0025-08	Dinner Knife	8-3/4"	Doz	1/25



## GRAPEFRUIT SPOON

Complete any table setting with this grapefruit spoon. The serrated edge cuts easily into any citrus fruit.

ITEM	DESCRIPTION	LENGTH	UOM	CASE
SRS-6	Grapefruit Spoon, Heavyweight	6-1/4"	Doz	1/25







The Elegance pattern in mirror finish features embossed floral embellishments with a single motif at the handle tip.

- ◆ 18/0 stainless steel
- ◆ Heavyweight
- ◆ Mirror finish

ITEM	DESCRIPTION	LENGTH	UOM	CASE
0024-01	Teaspoon	6-1/4"	Doz	1/50
0024-03	Dinner Spoon	7-1/8"	Doz	1/50
0024-04	Bouillon Spoon	6-3/16"	Doz	1/50
0024-05	Dinner Fork	7-3/8"	Doz	1/50

SEE PAGE 74 FOR COORDINATING ELEGANCE SERVING PIECES

The Elegance pattern in vibro finish features embossed floral embellishments with a single motif at the handle tip.

- ◆ 18/0 stainless steel
- ◆ Heavyweight
- ◆ Vibro finish

ITEM	DESCRIPTION	LENGTH	UOM	CASE
0004-01	Teaspoon	6-3/8"	Doz	1/50
0004-02	Iced Teaspoon	8"	Doz	1/50
0004-03	Dinner Spoon	7-1/4"	Doz	1/50
0004-04	Bouillon Spoon	6"	Doz	1/50
0004-05	Dinner Fork	7-1/4"	Doz	1/50
0004-06	Salad Fork	6-1/2"	Doz	1/50
0004-07	Oyster Fork	6"	Doz	1/50
0004-08	Dinner Knife	8-5/8"	Doz	1/25
0004-09	Demitasse Spoon	4-1/2"	Doz	1/50
0004-10	Tablespoon	8-3/8"	Doz	1/25

FLATWARE IN CLEAR VIEW PACK



- ◆ 18/0 stainless steel
- ◆ Medium weight
- ◆ Vibro finish

DOMINION IN CLEAR VIEW PACK

ITEM	DESCRIPTION	LENGTH	UOM	CASE
0081-01	Teaspoon, 2-Doz/Pk	5-13/16"	Pack	1/24
0081-02	Iced Teaspoon, 2-Doz/Pk	7-7/8"	Pack	1/24
0081-03	Dinner Spoon, 2-Doz/Pk	7"	Pack	1/24
0081-04	Bouillon Spoon, 2-Doz/Pk	6"	Pack	1/24
0081-05	Dinner Fork, 2-Doz/Pk	7-1/8"	Pack	1/24
0081-06	Salad Fork, 2-Doz/Pk	6-1/8"	Pack	1/24
0081-07	Oyster Fork, 2-Doz/Pk	5-5/8"	Pack	1/24
0081-08	Dinner Knife, 1-Doz/Pk	8"	Pack	1/24



WINDSOR IN CLEAR VIEW PACK

ITEM	DESCRIPTION	LENGTH	UOM	CASE
0082-01	Teaspoon, 2-Doz/Pk	5-7/8"	Pack	1/24
0082-02	Iced Teaspoon, 2-Doz/Pk	8"	Pack	1/24
0082-03	Dinner Spoon, 2-Doz/Pk	7"	Pack	1/24
0082-04	Bouillon Spoon, 2-Doz/Pk	6"	Pack	1/24
0082-05	Dinner Fork, 2-Doz/Pk	7"	Pack	1/24
0082-06	Salad Fork, 2-Doz/Pk	6-1/4"	Pack	1/24
0082-07	Oyster Fork, 2-Doz/Pk	5-1/2"	Pack	1/24
0082-08	Dinner Knife, 1-Doz/Pk	8"	Pack	1/24

The Dominion pattern features an art deco design with two lines down the length of the handle.

## DOMINION

- ◆ 18/0 stainless steel
- ◆ Medium weight
- ◆ Vibro finish

ITEM	DESCRIPTION	LENGTH	UOM	CASE
0001-01	Teaspoon	5-13/16"	Doz	1/50
0001-02	Iced Teaspoon	7-7/8"	Doz	1/50
0001-03	Dinner Spoon	7"	Doz	1/50
0001-04	Bouillon Spoon	6"	Doz	1/50
0001-05	Dinner Fork	7-1/8"	Doz	1/50
0001-06	Salad Fork	6-1/8"	Doz	1/50
0001-07	Oyster Fork	5-5/8"	Doz	1/50
0001-08	Dinner Knife	8"	Doz	1/25
0001-09	Demitasse Spoon	4-5/8"	Doz	1/50
0001-10	Tablespoon	7-5/8"	Doz	1/25

- ◆ 18/0 stainless steel
- ◆ Heavyweight
- ◆ Vibro finish

ITEM	DESCRIPTION	LENGTH	UOM	CASE
0014-01	Teaspoon	5-3/4"	Doz	1/50
0014-03	Dinner Spoon	7"	Doz	1/50
0014-04	Bouillon Spoon	5-7/8"	Doz	1/50
0014-05	Dinner Fork	7-1/16"	Doz	1/50
0014-06	Salad Fork	6-1/8"	Doz	1/50
0014-08	Dinner Knife, 55g	7-7/8"	Doz	1/25



The Windsor pattern is a classic that features a smooth contour design.

## WINDSOR

- ◆ 18/0 stainless steel
- ◆ Medium weight
- ◆ Vibro finish

ITEM	DESCRIPTION	LENGTH	UOM	CASE
0002-01	Teaspoon	5-7/8"	Doz	1/50
0002-02	Iced Teaspoon	8"	Doz	1/50
0002-03	Dinner Spoon	7"	Doz	1/50
0002-04	Bouillon Spoon	6"	Doz	1/50
0002-05	Dinner Fork	7"	Doz	1/50
0002-06	Salad Fork	6-1/4"	Doz	1/50
0002-07	Oyster Fork	5-1/2"	Doz	1/50
0002-08	Dinner Knife	8"	Doz	1/25
0002-09	Demitasse Spoon	4-5/8"	Doz	1/50
0002-10	Tablespoon	7-5/8"	Doz	1/25

- ◆ 18/0 stainless steel
- ◆ Heavyweight
- ◆ Vibro finish

ITEM	DESCRIPTION	LENGTH	UOM	CASE
0012-01	Teaspoon	5-15/16"	Doz	1/50
0012-03	Dinner Spoon	7"	Doz	1/50
0012-04	Bouillon Spoon	5-7/8"	Doz	1/50
0012-05	Dinner Fork	7-1/16"	Doz	1/50
0012-06	Salad Fork	6-1/8"	Doz	1/50
0012-08	Dinner Knife, 55g	8"	Doz	1/25



SERVING PIECES

SHANGARILA SERVING PIECES

- ◆ 18/8 stainless steel
- ◆ Extra heavyweight
- ◆ Mirror finish

ITEM	DESCRIPTION	LENGTH	UOM	CASE
0030-21	Large Bowl Serving Spoon	9"	Doz	1/10
0030-22	Cold Meat Fork	8-1/2"	Doz	1/10
0030-23	Solid Spoon	11-1/2"	Doz	1/10
0030-24	Banquet Slotted Spoon	11-1/2"	Doz	1/10
0030-25	Banquet Fork	12"	Doz	1/10

SHANGARILA SERVING SET



SEE PAGE 46 FOR COORDINATING SHANGARILA FLATWARE

HOLLOW HANDLE KNIVES

ITEM	DESCRIPTION	LENGTH	UOM	CASE
0015-10	Lafayette Dinner Knife	9-1/4"	Doz	1/15
0015-11	Lafayette Steak Knife	9-1/4"	Doz	1/15
0030-15	Shangarila Table Knife	9-1/4"	Doz	1/15
0034-15*	Stanford Dinner Knife	8-3/4"	Doz	1/15
0034-18*	Stanford Table Knife	9-5/8"	Doz	1/15

\*0034-15 & 0034-18 knives are suitable for any of our 18/8 patterns.







## ACERO STEAK KNIVES

With its sharp serrated edge and pointed tip, the Acero knife is designed to make simple work of cutting through steaks and chops. A stainless steel end cap provides excellent balance and control. This heavy-weight knife is a Winco exclusive and is a must-have on the tables of any steak house.



ITEM	DESCRIPTION	BLADE	UOM	CASE
SK-1	Acero Gourmet Steak Knives, 4-pc Gift Pack	5"	Pack	1/6
SK-12	Acero Gourmet Steak Knives, 12-pc Bulk Pack	5"	Doz	1/6
SK-22	Acero Gourmet Steak Knives, Round Tip	5"	Doz	1/6

## STEAK KNIVES



SK-SERIES

## WOODEN HANDLE KNIVES

ITEM	DESCRIPTION	BLADE	UOM	CASE
KB-30W	Jumbo Steak Knives, Pointed Tip	5"	Doz	1/12
KB-15W	Jumbo Steak Knives, Round Tip	5"	Doz	1/12
K-438W	Steak Knives, Pointed Tip and Handle	4-3/8"	Doz	1/24
K-55W	Steak Knives, Rounded Tip	4-1/2"	Doz	1/48
K-45W	Steak Knives, Pointed Tip	4-1/2"	Doz	1/48
K-35W	Economy Steak Knives, Pointed Tip	4"	Doz	1/48



## PLASTIC HANDLE KNIVES

ITEM	DESCRIPTION	BLADE	UOM	CASE
K-80P	Jumbo Steak Knives, Round Tip, 3 Rivets	5"	Doz	1/25
K-85P	Jumbo Steak Knives, Round Tip, 2 Rivets, NSF	5"	Doz	1/12
K-60P	Steak Knives, Pointed Tip, NSF	5"	Doz	1/24
K-50P	Steak Knives, Round Tip, NSF	5"	Doz	1/48



# VIRTUOSO

EXTRA HEAVYWEIGHT SERIES

CONDENSATION CHANNEL KEEPS TABLE DRY



101A



101B



103A



103B

ITEM	DESCRIPTION	UOM	CASE
101A	8 Qt Full-Size, Gold Accent	Set	1
101B	8 Qt Full-Size	Set	1
103A	6 Qt Round, Gold Accent	Set	1
103B	6 Qt Round	Set	1
101-WP	Water Pan for 101A, 101B	Each	1
103-WP	Water Pan for 103A, 103B	Each	5
NSF SPF2	Food Pan for 101A, 101B, NSF	Each	6/12
602-FP	Food Pan for 103A, 103B	Each	12
SPFD-2R	Round Divided Food Pan for 103A, 103B	Each	10
C-F1	Fuel Holder with Cover	Each	12/48

Create the ultimate modern buffet presentation with the Virtuoso collection of premium chafers. Featuring beautiful, clean styling and optional gold-plated accents.

- ◆ 18/8 stainless steel mirror finish
- ◆ Roll-top cover opens to 90° or 180°
- ◆ Condensation from cover interior drips into water pan and keeps table surface dry
- ◆ Includes food pan, water pan and fuel holder(s)
- ◆ Stackable

SEE PAGE 70 FOR MATCHING VIRTUOSO COFFEE URNS





# VINTAGE

## EXTRA HEAVYWEIGHT SERIES



108A



308A

Create the most elegant buffet setting with the Vintage collection of premium chafers. Featuring gleaming mirror finish dome covers and curved legs in gold accents.

- ◆ Stainless steel mirror finish
- ◆ Roll-top cover opens to 90° or 160°
- ◆ Includes food pan, water pan and fuel holder(s)

ITEM	DESCRIPTION	UOM	CASE
108A	8 Qt Full-Size	Set	1
308A	6 Qt Round	Set	1
108A-WP	Water Pan for 108A	Each	10
602-WP	Water Pan	Each	12
NSF SPF2	Food Pan for 108A, NSF	Each	6/12
602-FP	Food Pan for 308A		12
SPFD-2R	Round Divided Food Pan for 308A	Each	10
C-F1	Fuel Holder with Cover	Each	12/48





**MADISON**  
HEAVYWEIGHT SERIES



601

- ◆ A modern design, perfect for casual and formal settings
- ◆ Stainless steel with highly polished mirror finish dome covers
- ◆ Roll-top covers can stay open at any angle
- ◆ Includes food pan, water pan and fuel holder(s)

ITEM	DESCRIPTION	UOM	CASE
601	8 Qt Full-Size	Set	1
602	6 Qt Round	Set	1
603	8 Qt Oval	Set	1
601-WP1	Water Pan for 601	Each	8
602-WP	Water Pan for 602	Each	12
603-WP	Water Pan for 603	Each	6
NSF SPF2	Food Pan for 601, NSF	Each	6/12
602-FP	Food Pan for 602	Each	12
SPFD-2R	Round Divided Food Pan for 602	Each	10
603-FP	Food Pan for 603	Each	10
C-F1	Fuel Holder with Cover	Each	12/48



602



603

SEE PAGE 69 FOR ELECTRIC WATER PAN TO FIT FULL-SIZE CHAFERS



**DALLAS**  
HEAVYWEIGHT SERIES

- ◆ Solid design with gold accented handles
- ◆ Available with lift-off or roll-top cover options
- ◆ Polished stainless steel with mirror finish covers
- ◆ Includes food pan, water pan and fuel holder(s)

ITEM	DESCRIPTION	UOM	CASE
C-5080	8 Qt Full-Size, Roll-top	Set	1
C-RTC	Roll-top Cover for C-5080	Each	1
C-WPF	Water Pan for C-5080	Each	6
NSF SPF2	Food Pan for C-5080, NSF	Each	6/12
C-F1	Fuel Holder with Cover	Each	12/48



C-5080



- ◆ Elegance combined with ornate details, the Crown collection is designed exclusively for formal settings
- ◆ Stainless steel mirror finish
- ◆ Includes food pan, water pan and fuel holder(s)
- ◆ Wooden handles

**CROWN**  
**MEDIUM-WEIGHT SERIES**

ITEM	DESCRIPTION	UOM	CASE
▶ 408-1	8 Qt Full-Size	Set	1
▶ 508	4 Qt Half-Size, Square	Set	1
▶ 708	6 Qt, Round	Set	1
C-WPF	Water Pan for 408-1	Each	6
508-WP	Water Pan for 508	Each	6
708-WP	Water Pan for 708	Each	1/6
NSF SPF2	Food Pan for 408-1, NSF	Each	6/12
508-FP	Food Pan for 508	Each	10
708-FP	Food Pan for 708	Each	1/6
C-F1	Fuel Holder with Cover	Each	12/48



- ◆ Classic art deco design with gold accents
- ◆ Polished stainless steel with mirror finish covers
- ◆ 8 quart full-size chafers features a frame clip for the cover
- ◆ Includes food pan, water pan and fuel holder(s)

**MALIBU**  
**MEDIUM-WEIGHT SERIES**

ITEM	DESCRIPTION	UOM	CASE
▶ 201	8 Qt Full-Size	Set	1
▶ 202	6 Qt Oval	Set	1
▶ 203	4 Qt Round	Set	1
C-WPF	Water Pan for 201	Each	6
202-WP	Water Pan for 202	Each	12
203-WP	Water Pan for 203	Each	12
NSF SPF2	Food Pan for 201, NSF	Each	6/12
202-FP	Food Pan for 202	Each	12
203-FP	Food Pan for 203	Each	12
C-F1	Fuel Holder with Cover	Each	12/48



**NEWBURG**  
**ECONOMY-WEIGHT SERIES**



C-3080B



Handy clips hold lid in place

- ◆ Simple, elegant and functional design
- ◆ Clips on frame conveniently hold cover when open
- ◆ High legs allow for extra space to prevent fuel holder bottoms from overheating table surface
- ◆ Includes water pan, food pan, two fuel holders and plastic handle

ITEM	DESCRIPTION	UOM	CASE
C-3080B	8 Qt Full-Size	Set	1
C-WPF	Water Pan for C-3080B	Each	6
SPF2	Food Pan for C-3080B, NSF	Each	6/12
C-F1	Fuel Holder with Cover	Each	12/48

**GET-A-GRIP™**



C-2080B



Handy clips hold lid in place



Patented Get-A-Grip™ handle system

- ◆ Simple design with patented food pan that features safety handles, preventing steam burns
- ◆ Clips on frame conveniently hold cover when open
- ◆ Includes water pan, specially designed food pan and two fuel holders

ITEM	DESCRIPTION	UOM	CASE
C-2080B	8 Qt Full-Size	Set	1
C-WPF	Water Pan for C-2080B	Each	6
SPF2-HD	Food Pan with Handle for C-2080B, NSF	Each	6
C-F1	Fuel Holder with Cover	Each	12/48

**FOLDING CHAFERS**



C-1080

**SOLID FRAME CONSTRUCTION PROVIDES EXTRA STABILITY**



C-1080 Folding Frame

*For the on-the-go caterer, there are two full-size chafers with foldable frames available. The collapsible stand conveniently folds down and reassembles in seconds, great for space saving storage, and especially convenient for transporting food to events.*

- ◆ Constructed of stainless steel with built-in clips to hold covers in place for easy and convenient refilling and serving
- ◆ Each chafers set includes water pan, food pan, frame, cover and two fuel holders

**BELLAIRE HEAVYWEIGHT CHAFER**

- ◆ Sturdy and heavyweight, the sculpted legs on this folding chafers provide convenience without sacrificing elegance

ITEM	DESCRIPTION	UOM	CASE
C-1080	8 Qt Full-Size	Set	1
C-WPF	Water Pan for C-1080	Each	6
SPF2	Food Pan for C-1080, NSF	Each	6/12
C-F1	Fuel Holder with Cover	Each	12/48



C-4080



C-4080 Folding Frame

**ECONOMY-WEIGHT CHAFER**

- ◆ Lighter in weight for maximum mobility, the simple design of this chafers is versatile enough to serve up food at any event.

ITEM	DESCRIPTION	UOM	CASE
C-4080	8 Qt Full-Size	Set	1
C-WPF	Water Pan for C-4080	Each	6
SPF2	Food Pan for C-4080, NSF	Each	6/12
C-F1	Fuel Holder with Cover	Each	12/48



### STAINLESS STEEL SOUP WARMERS

Enhance the look of a serving table with this stainless steel chafers-style soup warmer in 7 and 11 quart capacities.

- ◆ Includes cover, water pan and fuel holder

ITEM	DESCRIPTION	UOM	CASE
211	11 Qt Warmer	Set	1
207	7 Qt Warmer	Set	1
211-WP	Water Pan for 211	Each	12
207-WP	Water Pan for 207	Each	12
INS-11.0M	11 Qt Inset Pan for 211, 24 gauge	Each	6/12
INS-7.0M	7 Qt Inset Pan for 207, 24 gauge	Each	6/24
INSC-11M	Cover For 11 Qt Inset	Each	6/36
INSC-7M	Cover For 7 Qt Inset	Each	6/48
INSH-11	Hinged Cover For 11 Qt Inset	Each	6/24
INSH-7	Hinged Cover For 7 Qt Inset	Each	6/24
C-F1	Fuel Holder with Cover	Each	12/48

### STAINLESS STEEL SOUP WARMERS



211

207



### ELECTRIC WATER PAN

- ◆ Stands alone or fits standard full-size chafers frames for an electric alternative (food pan sold separately)
- ◆ Accommodates full-size steam table pans
- ◆ Powerful, efficient 900W heating element warms faster; temperature is adjustable
- ◆ 120V~60Hz, 900W, 7.5A
- ◆ Dimensions: 22-5/8"L x 13-5/8"W x 7"H
- ◆ One year parts and labor warranty

ITEM	DESCRIPTION	UOM	CASE
EWP-2	900W, Full Size	Each	1

### ELECTRIC 900W WATER PAN



Fits inside standard full-size chafers

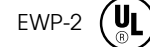

### CHAFFER STAND

- ◆ Only fits steam table pans and water pans
- ◆ Do not use with aluminum foil pans

ITEM	DESCRIPTION	UOM	CASE
C-3F	Full-Size Stand	Each	10

### CHAFING PAN HOLDERS

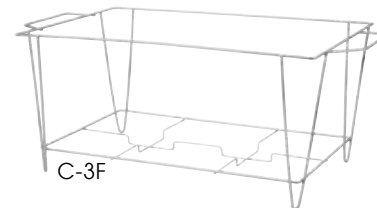

C-3F

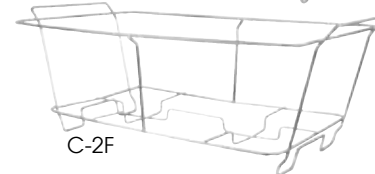

C-2F



### CHAFFER STAND FOR ALUMINUM FOIL TRAYS

ITEM	DESCRIPTION	UOM	CASE
C-2F	Full-Size Stand	Each	10



### CHAFFER FUEL CANS

These wick-type reusable chafers fuel cans fit any standard fuel holder. The screw-on cap provides a secure seal for transporting and storage.

- ◆ Diethylene glycol fuel, wick-type
- ◆ Twist cap allows easy storage, reusable
- ◆ Recommended for chafing dishes and beverage urns
- ◆ Available in 2-, 4- and 6-hour burn times
- ◆ Sold in full case only

ITEM	DESCRIPTION	UOM	CASE
C-F2	Chafing Fuel, 2 Hour Burn Time	Each	24
C-F4	Chafing Fuel, 4 Hour Burn Time	Each	24
C-F6	Chafing Fuel, 6 Hour Burn Time	Each	24

### TWIST-CAP WICK FUEL CANS



C-F6



C-F2

VIRTUOSO COFFEE URNS

SEE PAGE 64  
FOR MATCHING  
VIRTUOSO  
CHAFERS

The modern design of the Virtuoso urns will add a stylish touch to any coffee and tea self-service station. The gleaming mirror-finish body is available in 3 gallon and 5 gallon capacities. A single fuel canister will keep contents warm and ready for dispensing.

- ◆ Made of extra-heavyweight stainless steel
- ◆ Available with gold accent legs or all stainless steel finish

VIRTUOSO COFFEE URNS

ITEM	DESCRIPTION	UOM	CASE
905A	5 Gallon, Gold Legs	Set	1
905B	5 Gallon, S/S	Set	1
903A	3 Gallon, Gold Legs	Set	1
903B	3 Gallon, S/S	Set	1
FAUCET-CU	Stainless Steel Faucet	Each	1
FAUCET-JD	Plastic Faucet	Each	1



905A



903A



FAUCET-CU



FAUCET-JD



905B



903B



PUNCH BOWL

PUNCH BOWL

- ◆ Stainless steel mirror finish

ITEM	DESCRIPTION	UOM	CASE
SPB-35	3-1/2 Gal Punch Bowl with Decorative Ring Hds	Each	6



SPB-35

The container of each dispenser holds up to 2.2 gallons and features an ice core in the center that keeps juices chilled without watering them down.

- ◆ Available in two-tone with gold accents or in all stainless steel
- ◆ Mirror finish
- ◆ Removable container and drip tray for easy cleaning
- ◆ Break-resistant polycarbonate containers

## JUICE DISPENSERS



### SINGLE JUICE DISPENSERS

ITEM	DESCRIPTION	UOM	CASE
901	Two-tone	Set	1
902	Stainless Steel	Set	1



901  
10-1/8"L x 13-3/4"W x 21-1/4"H

902  
10-1/8"L x 13-3/4"W x 21-1/4"H

### ACCESSORIES FOR JUICE DISPENSERS

ITEM	DESCRIPTION	UOM	CASE
901-FN	Faucet for 901, 902	Each	12/48
901-P1	PC Jar for 901, 902	Each	4



901-FN



901-P1

With oversized black letters on stainless steel, these beverage tent and chain signs are must-haves for buffets and beverage stations.

## STAINLESS STEEL BEVERAGE SIGNS

### TENT SIGNS

- ◆ 3"L x 1-1/4"H x 1-1/2"D

ITEM	DESCRIPTION	UOM	CASE
SGN-100	Blank Sign	Each	12/120
SGN-101	Hot Tea	Each	12/120
SGN-102	Decaf	Each	12/120
SGN-103	Coffee	Each	12/120
SGN-104	Hot Water	Each	12/120
SGN-105	Iced Tea	Each	12/120



SGN-SERIES TENT SIGNS

### CHAIN SIGNS

- ◆ 3-1/2"L x 1-3/4"W sign with 12" long chain

ITEM	DESCRIPTION	UOM	CASE
SGN-201	Hot Tea	Each	12/120
SGN-202	Decaf	Each	12/120
SGN-203	Coffee	Each	12/120
SGN-204	Hot Water	Each	12/120
SGN-205	Iced Tea	Each	12/120



SGN-SERIES CHAIN SIGNS



### DRIP TRAYS

- ◆ Dishwasher safe with removable grid.
- ◆ Each pack contains four (4) pieces
- ◆ BPA-free

ITEM	DESCRIPTION	UOM	CASE
DT-45	4-1/2" Tray, 4 pcs/pk	Pack	12/24
DT-60	6" Tray, 4 pcs/pk	Pack	12/24

## DRIP TRAYS



DT-45



DT-60

DT-SERIES





## DISPLAY TRAYS & RISERS



HRS-4



HPO-12

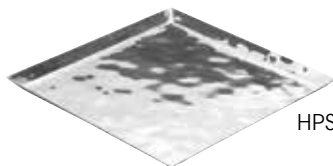

HPS-12



HPR-10

Made of 18/8 stainless steel, the surfaces of these trays and risers exhibit a glossy ripple effect in a gleaming mirror-finish, truly unique and elegant pieces for showcasing appetizers and desserts.

- ◆ Durable and stable surface for displaying
- ◆ Not recommended for prolonged use with acidic, creamy or salty ingredients
- ◆ Hand wash recommended

### NESTING RISER DISPLAY

- ◆ 4-piece nesting set

ITEM	DESCRIPTION	UOM	CASE
HRS-4	Riser 1: 5-1/2" x 5-1/2" x 5-1/2" Riser 2: 6-5/8" x 6-5/8" x 6-5/8" Riser 3: 7-7/8" x 7-7/8" x 7-7/8" Riser 4: 9" x 9" x 9"	Set	4

### DISPLAY TRAYS

- ◆ Available in a variety of shapes and sizes

ITEM	DESCRIPTION	SIZE	UOM	CASE
HPO-12	Rectangular	12-5/8" x 7-1/4" x 1"	Each	12
HPO-14	Rectangular	13-3/4" x 7-3/4" x 1"	Each	12
HPO-15	Rectangular	15" x 8-1/2" x 1"	Each	12
HPS-10	Square	10-1/4" x 10-1/4" x 5/8"	Each	12
HPS-12	Square	11-3/4" x 11-3/4" x 5/8"	Each	12
HPS-13	Square	13-1/4" x 13-1/4" x 5/8"	Each	12
HPR-8	Round	8-7/8"Dia x 1-5/8"	Each	12
HPR-9	Round	9-5/8"Dia x 1-5/8"	Each	12
HPR-10	Round	10-1/4"Dia x 1-5/8"	Each	12

## TIERED GLASS BOWL DISPLAYS



TDS-3



TDSF-4

## TIERED GLASS BOWL DISPLAYS

These multi-tiered glass bowl servers provide a modern and attractive way to display cold salads, fruits and breads.

- ◆ 18/8 stainless steel mirror-finish arms and bases
- ◆ Glass bowls are removable for easy cleaning, and microwave and dishwasher safe
- ◆ Available in 3-tier graduated set or 4-tier arm set
- ◆ Arms on the 4-tier set rotate 360°

ITEM	DESCRIPTION	UOM	CASE
TDS-3	3-Tier Set Base 9-7/8"Dia x 19-3/4"H	Set	1
TDSF-4	4-Tier Set Base 8-3/4"Dia x 20-1/2"H Bowl arms rotate 360°	Set	1
TDS-3-GLAS	Glass Bowl for TDS-3	Each	12
TDSF-4-GLS	Glass Bowl for TDSF-4	Each	12

**CHROME SERVING TRAYS**

The classic gadroon edge and traditional engraving of these chrome-plated trays are perfect for tea and coffee service, as well as pastries, appetizers and desserts.

- ◆ Available in a variety of shapes and sizes
- ◆ Not recommended for prolonged use with meat or acidic ingredients
- ◆ Hand wash only

ITEM	DESCRIPTION	SIZE	UOM	CASE
CMT-1912	Rectangular with Handles	19-1/2" x 12-1/2"	Each	12/24
CMT-1217	Octagonal	17" x 12-1/2"	Each	12/24
CMT-1420	Octagonal	20" x 14"	Each	12/24
CMT-1812	Rectangular	18" x 12-1/2"	Each	12/24
CMT-2014	Rectangular	20" x 14"	Each	12/24
CMT-1014	Oval	14-3/4" x 10-1/2"	Each	12/24
CMT-1318	Oval	18-3/4" x 13"	Each	12/24
CMT-14	Round	14"	Each	12/24



CMT-14



CMT-1318



CMT-1912



CMT-1420



CMT-2014

**CLIPS & HOLDERS**

**MENU HOLDER CLIPS**

ITEM	DESCRIPTION	SIZE	UOM	CASE
MH-1	Harp Clip, Heavy-Cast Base	1"L x 1"W x 1-1/2"H	Doz	10/60
MH-2	Ring-Type	2-1/2" x 2-1/3"	Doz	2/20
MH-2C	Clip	2-1/2" x 2-1/2"	Doz	1/40



MH-1



MH-2



MH-2C

**TABLE SIGN HOLDERS**

Stylish and discreet, these table sign holders are perfect for buffet and table seating.

ITEM	DESCRIPTION	UOM	CASE
TCD-2	Table Sign Holder, Cast Aluminum, 2 pcs/pk	Pack	24/240
TCD-3C	Table Sign Clip, "C" Base, 6 pcs/pk	Pack	4/96
TCD-3S	Table Sign Clip, "S" Base, 6 pcs/pk	Pack	4/96
TCD-4D	Table Sign Clip, Double Sided Clips, Flexible, 6 pcs/pk	Pack	48/192
TCD-4S	Table Sign Clip, Acrylic Square Base, 6 pcs/pk	Pack	4/48
TCD-4T	Table Sign Clip, Acrylic Triangle Base, 6 pcs/pk	Pack	4/48



TCD-2



TCD-3C



TCD-3S



TCD-4D



TCD-4S



TCD-4T

STAINLESS STEEL BUFFET SERVICE



BW-NS3 BW-SL2 BW-SS1 BW-BF BW-CF BW-PS5 BW-WPS6 BW-DL BW-DK8 BW-DK9 BW-SP1 BW-SP2 BW-TN



SHANGARILA SERVING PIECES



LE-1

LE-2

LE-4

LE-11

LE-13

LE-20



SRS-2



SRS-8



STS-9



STS-13

HOLLOW HANDLE BUFFETWARE

Plating and serving has never been easier than with our collection of hollow handle stainless steel buffetware.

ITEM	DESCRIPTION	LENGTH	UOM	CASE
BW-NS3	Notched Spoon	11-3/4"	Each	12/72
BW-SL2	Slotted Spoon	11-3/4"	Each	12/72
BW-SS1	Solid Spoon	11-3/4"	Each	12/72
BW-BF	Pot Fork, Two Tines	11"	Each	12/72
BW-CF	Cold Meat Fork	10"	Each	12/72
BW-PS5	Pie Server	11"	Each	12/72
BW-WPS6	Wide Pie Server	11-1/2"	Each	12/72
BW-DL	Deep Ladle	4 Oz	Each	12/72
BW-DK8	Carving Knife, Wave-Edge Blade	8"	Each	12/72
BW-DK9	Slicer/Wedding Cake Knife, Wave-Edge	9"	Each	12/72
BW-SP1	Spout Ladle	1 Oz	Each	12/72
BW-SP2	Spout Ladle	2 Oz	Each	12/72
BW-TN	Perforated Turner	14"	Each	12/72

SHANGARILA SERVING PIECES

◆ Extra heavyweight 18/8 stainless steel mirror finish

ITEM	DESCRIPTION	LENGTH	UOM	CASE
0030-21	Large Bowl Serving Spoon	9"	Doz	1/10
0030-22	Cold Meat Fork	8-1/2"	Doz	1/10
0030-23	Solid Spoon	11-1/2"	Doz	1/10
0030-24	Banquet Slotted Spoon	11-1/2"	Doz	1/10
0030-25	Banquet Fork	12"	Doz	1/10

ELEGANCE SERVING PIECES

ITEM	DESCRIPTION	LENGTH	UOM	CASE
LE-1	Gravy & Soup Ladle, 1 Oz	7"	Doz	1/36
LE-2	Gravy & Soup Ladle, 2 Oz	9"	Each	12/120
LE-4	Gravy & Soup Ladle, 4 Oz	13"	Each	12/120
LE-11	Solid Spoon	11"	Each	12/120
LE-13	Solid Spoon	13"	Each	12/120
LE-20	Fork	13"	Each	12/120

SERVING SPOONS

ITEM	DESCRIPTION	LENGTH	UOM	CASE
SRS-2	Round Edge	8-5/8"	Doz	1/25
SRS-8	Flat Edge	8-1/4"	Doz	1/25

SPAGHETTI SERVERS

ITEM	DESCRIPTION	LENGTH	UOM	CASE
STS-9	Small	9"	Each	12/144
STS-13	Large	13"	Each	12/144



**SERVING TONGS**

These heavyweight, 18/8 satin-finish stainless steel serving tongs are designed for comfortable service in elegant settings.

- ◆ Great for buffets, catered events and more
- ◆ Dishwasher safe

ITEM	DESCRIPTION	SIZE	UOM	CASE
STH-8	Short	8-1/2"	Each	12/72
STH-10	Medium	10-1/2"	Each	12/72
STH-13	Long	13-1/2"	Each	12/72

**STAINLESS STEEL SERVING TONGS**



**SALAD TONGS**

ITEM	DESCRIPTION	SIZE	UOM	CASE
PTOS-8	Oval Salad Tong, Satin Finish	7-3/4"	Each	12/96
ST-2	Double Spoon, Mirror Finish	10"	Each	6/60
ST-10	Fork and Spoon, Satin Finish	10"	Each	6/60
▶ ST-10S	Slotted and Solid Spatula, Mirror Finish	10"	Each	12/96
▶ ST-105SF	Spatula and Fork, Mirror Finish	10-1/2"	Each	12/96



**PASTRY TONGS**

ITEM	DESCRIPTION	SIZE	UOM	CASE
PT-8	Solid with Short Handle	7-1/2"	Each	12/120
PT-875	Solid with Long Handle	8-3/4"	Each	12/144
▶ PT-10P	Perforated Scissor Style	10-1/2"	Each	12/96



**SPAGHETTI TONG**

ITEM	DESCRIPTION	SIZE	UOM	CASE
ST-8	Mirror Finish	8"	Each	12/240



**ICE TONGS**



ITEM	DESCRIPTION	SIZE	UOM	CASE
▶ ICT-7	Five Prong, Textured	7"	Each	12/144
IT-7	Three Prong, Satin Finish	7"	Each	12/120



**POM TONGS**

ITEM	DESCRIPTION	SIZE	UOM	CASE
PT-6	Satin Finish	6"	Doz	4/24
PT-9	Satin Finish	9"	Doz	4/24



**POLYCARBONATE  
SERVING UTENSILS**



**NSF** PUT-SERIES



PUTF-6K



**NSF** PPT-SERIES



PSSB-SERIES



PSS-SERIES



PLD-SERIES

**SERVING TONGS**

ITEM	DESCRIPTION	SIZE	UOM	CASE
PUT-6B	Beige	6"	Each	12/192
PUT-6C	Clear	6"	Each	12/192
PUT-6K	Black	6"	Each	12/192
PUT-6R	Red	6"	Each	12/192
PUT-9B	Beige	9"	Each	12/144
PUT-9C	Clear	9"	Each	12/144
PUT-9K	Black	9"	Each	12/144
PUT-9R	Red	9"	Each	12/144
PUT-9W	White	9"	Each	12/144
PUT-12B	Beige	12"	Each	12/144
PUT-12C	Clear	12"	Each	12/144
PUT-12K	Black	12"	Each	12/144
PUT-12R	Red	12"	Each	12/144

**FLAT TONGS**

ITEM	DESCRIPTION	SIZE	UOM	CASE
PUTF-6B	Beige	6"	Each	12/432
<b>NSF</b> PUTF-6C	Clear, NSF	6"	Each	12/432
PUTF-6K	Black	6"	Each	12/432

**SPAGHETTI TONGS**

◆ Heat-resistant up to 302°F (150°C)

ITEM	DESCRIPTION	SIZE	UOM	CASE
PPT-11B	Beige	11"	Each	24/144
PPT-11C	Clear	11"	Each	24/144
PPT-11K	Black	11"	Each	24/144

**BUFFET SPOONS**

◆ 3/4 oz capacity

ITEM	DESCRIPTION	SIZE	UOM	CASE
PSSB-10B	Beige	10"	Each	12/384
<b>NSF</b> PSSB-10C	Clear, NSF	10"	Each	12/384
PSSB-10K	Black	10"	Each	12/384
PSSB-10R	Red	10"	Each	12/384

**SERVING SPOONS**

ITEM	DESCRIPTION	SIZE	UOM	CASE
PSS-13C	Clear	13"	Doz	12
PSS-13K	Black	13"	Doz	12
PSS-13R	Red	13"	Doz	12
PSS-15K	Black	15"	Doz	12

**ONE-PIECE LADLES**

ITEM	DESCRIPTION	SIZE	UOM	CASE
PLD-8B	3/4 Oz, Beige	8-1/2"	Each	12/192
PLD-8C	3/4 Oz, Clear	8-1/2"	Each	12/192
PLD-8K	3/4 Oz, Black	8-1/2"	Each	12/192
PLD-8R	3/4 Oz, Red	8-1/2"	Each	12/192
PLD-13B	1 Oz, Beige	13"	Each	12/192
PLD-13C	1 Oz, Clear	13"	Each	12/192
PLD-13K	1 Oz, Black	13"	Each	12/192
PLD-13R	1 Oz, Red	13"	Each	12/192

Artfully present single-serve portions in copper and stainless steel finished tri-ply mini cookware.

- ◆ Tri-ply construction with either stainless steel or copper exterior, all induction ready
- ◆ Aluminum core provides efficient heat distribution
- ◆ 18/8 stainless steel cookware surface for superior cooking performance

## MINI COOKWARE



### TRI-PLY MINI COOKWARE WITH COPPER EXTERIOR

ITEM	DESCRIPTION	UOM	CASE
DCCR-3C	3.75" Casserole, 15 oz	Each	1/30
DCFP-4C	4" Fry Pan, 5 oz	Each	1/30
DCSC-3C	3" Saucier, 5 oz	Each	1/30
DCSP-3C	3.5" Sauce Pan, 11 oz	Each	1/30

### TRI-PLY MINI COOKWARE WITH STAINLESS STEEL EXTERIOR

ITEM	DESCRIPTION	UOM	CASE
DCCR-3S	3.75" Casserole, 15 oz	Each	1/30
DCFP-4S	4" Fry Pan, 5 oz	Each	1/30
DCSC-3S	3" Saucier, 5 oz	Each	1/30
DCSP-3S	3.5" Sauce Pan, 11 oz	Each	1/30

### TRI-PLY MINI COOKWARE LIDS

ITEM	DESCRIPTION	UOM	CASE
DCL-35	Lid for 3.5" DCSP, Sauce Pan	Each	1/50
DCL-375	Lid for 3.75" DCCR, Casserole	Each	1/50





MINI COOKWARE



DCWE-105S



DCWE-201C



DCWC-101S



DCWC-201C



DCWB-101S



DCWA-101S



DCWA-201C



DCWD-101S



DDSC-101S

Artfully cook and present single-serve portions in copper and stainless steel finish mini-ware.



STAINLESS STEEL MINI CASSEROLES

ITEM	DESCRIPTION	UOM	CASE
DCWE-101S	2-3/4" Dia x 1-3/4" H	Each	12/36
DCWE-102S	3-1/8" Dia x 1-3/4" H	Each	12/36
DCWE-103S	3-1/2" Dia x 2" H	Each	12/36
DCWE-104S	4-1/4" Dia x 2-3/8" H	Each	12/36
DCWE-105S	4-3/4" Dia x 3" H	Each	12/36



COPPER-PLATED MINI CASSEROLES

ITEM	DESCRIPTION	UOM	CASE
DCWE-201C	2-3/4" Dia x 1-3/4" H	Each	12/36
DCWE-202C	3-1/8" Dia x 1-3/4" H	Each	12/36
DCWE-203C	3-1/2" Dia x 2" H	Each	12/36
DCWE-204C	4-1/4" Dia x 2-3/8" H	Each	12/36
DCWE-205C	4-3/4" Dia x 3" H	Each	12/36



STAINLESS STEEL MINI FRY PANS

ITEM	DESCRIPTION	UOM	CASE
DCWC-101S	4" Dia x 1-1/8" H	Each	12/96
DCWC-102S	4-1/2" Dia x 1-3/8" H	Each	12/72
DCWC-103S	5" Dia x 1-1/8" H	Each	12/48



COPPER MINI FRY PAN

ITEM	DESCRIPTION	UOM	CASE
DCWC-201C	5-1/2" Dia x 1-3/8" H	Each	12/48



STAINLESS STEEL MINI TAPERED SAUCE PANS

ITEM	DESCRIPTION	UOM	CASE
DCWB-101S	2-3/4" Dia x 1-3/4" H	Each	12/72
DCWB-102S	3-3/8" Dia x 2-3/8" H	Each	12/72
DCWB-103S	4" Dia x 2-3/8" H	Each	12/48



STAINLESS STEEL MINI SAUCE PANS

ITEM	DESCRIPTION	UOM	CASE
DCWA-101S	2" Dia x 1-3/16" H	Each	12/120
DCWA-102S	2-3/4" Dia x 1-3/4" H	Each	12/120
DCWA-103S	3-1/8" Dia x 1-3/4" H	Each	12/96
DCWA-104S	3-1/2" Dia x 2" H	Each	12/48
DCWA-105S	4-3/8" Dia x 2-3/8" H	Each	12/48
DCWA-106S	5" Dia x 3" H	Each	12/48



COPPER-PLATED MINI SAUCE PANS

ITEM	DESCRIPTION	UOM	CASE
DCWA-201C	2" Dia x 1-3/16" H	Each	12/120
DCWA-202C	2-3/4" Dia x 1-3/4" H	Each	12/120
DCWA-203C	3-1/8" Dia x 1-3/4" H	Each	12/96
DCWA-204C	3-1/2" Dia x 2" H	Each	12/48
DCWA-205C	4-3/8" Dia x 2-3/8" H	Each	12/48
DCWA-206C	5" Dia x 3" H	Each	12/48



STAINLESS STEEL MINI WOKS

ITEM	DESCRIPTION	UOM	CASE
DCWD-101S	3-3/8" Dia x 1" H	Each	12/96
DCWD-102S	4" Dia x 1-3/16" H	Each	12/96



STAINLESS STEEL MINI COLANDERS

ITEM	DESCRIPTION	UOM	CASE
DDSC-101S	3-3/4" Dia	Each	12/120
DDSC-102S	4" Dia	Each	12/120
DDSC-103S	5-1/8" Dia	Each	12/72

**STAINLESS STEEL MINI ROASTING PANS**

ITEM	DESCRIPTION	UOM	CASE
DDSB-101S	4-1/2" Sq	Each	12/72
DDSB-102S	5-3/16" Sq	Each	12/48
DDSB-103S	5"L x 3-3/8"W	Each	12/72
DDSB-104S	5-3/4"L x 3-3/4"W	Each	12/72

**COPPER-PLATED MINI ROASTING PANS**

ITEM	DESCRIPTION	UOM	CASE
DDSB-201C	4-1/2" Sq	Each	12/72
DDSB-202C	5-3/16" Sq	Each	12/48
DDSB-203C	5"L x 3-3/8"W	Each	12/72
DDSB-204C	5-3/4"L x 3-3/4"W	Each	12/72

**MINI ROASTING PANS**



**KADY BOWLS**

*Elegantly serve saucy dishes in our stainless steel mirror-finish kady bowls.*

- ◆ Durable stainless steel
- ◆ Elegant mirror finish
- ◆ Handles allow for easy transport of hot dishes
- ◆ Great for serving, displays and more

ITEM	DESCRIPTION	UOM	CASE
KDB-5	5"Dia	Each	6/96
KDB-6	6"Dia	Each	6/72
KDB-7	7"Dia	Each	6/48

**KADY BOWLS**



**CAST IRON CASSEROLE WOK**

- ◆ Authentic cast iron wok in mini tabletop serving size

ITEM	DESCRIPTION	UOM	CASE
CSW-75	7"Dia x 2"H	Set	12

**CAST IRON MINI WOK**



**CARBON STEEL COOK & SERVEWARE**

*These Spanish-made, blini pans are ideal for adding a rustic look to fresh-cooked eggs or displaying individual Mediterranean dishes!*

ITEM	DESCRIPTION	UOM	CASE
CSPP-4	4-3/4", Polished	Each	40
CSPP-4E	4-3/4", Non-Stick	Each	40

**MINI COOKWARE**



4-3/4" DIA. INDIVIDUAL SERVING SIZE



MADE IN SPAIN

INDUCTION READY

## FRY CUPS



SFCW-4S



SFC-35



SFC-35H



WBKH-5



WBKH-10



### FRY CUPS

A sleek and trendy way to display side dishes. Perfect for serving fries, calamari, onion rings and other small portion finger foods!

- ◆ Durable satin-finish stainless steel
- ◆ Great for serving, displays and more
- ◆ 3-1/4" diameter x 3-1/2" high

ITEM	DESCRIPTION	UOM	CASE
SFC-35	Smooth Exterior	Each	12/120
SFC-35H	Hammered Exterior	Each	12/120



### FRY CUP WITH WIRE HOLDER

- ◆ Stainless steel

ITEM	DESCRIPTION	UOM	CASE
SFCW-4S	4"Dia	Set	12/48



### FRENCH FRY HOLDERS

ITEM	DESCRIPTION	UOM	CASE
WBKH-5	1-Cone, Holds 2 Oz Ramekins	Each	12
WBKH-10	3-Cone	Each	4

## MINI SERVING BASKETS



FBM-544T



FBM-32R



FBM-554S



### MINI SERVING BASKETS

Add some contemporary style to a buffet setting or tabletop dining with these mini baskets, a novel way to present and serve side dishes or appetizers.

- ◆ 18/8 stainless steel
- ◆ Great for serving individual portions
- ◆ Dishwasher safe

ITEM	DESCRIPTION	UOM	CASE
FBM-32R	Round, 3-3/4"Dia x 2-7/8"H	Each	12/72
FBM-443S	Square, 4"L x 4"W x 3"H	Each	12/72
FBM-554S	Square, 5"L x 5"W x 4"H	Each	12/72
FBM-433T	Rectangular, 4"L x 3"W x 3"H	Each	12/72
FBM-544T	Rectangular, 5"L x 4"W x 4"H	Each	12/72

## TACO SERVICE

NSF

BPA FREE

PTS-4



TCHS-23MN



TCHS-23



TCHS-12



TCHS-34



TCHS-45



### TACO SERVER

- ◆ Holds up to four (4) tacos
- ◆ Each pack comes with 2 pcs

ITEM	DESCRIPTION	UOM	CASE
PTS-4	8"L x 5"W x 2"H	Pack	1/16



### MINI TACO HOLDERS

- ◆ Stainless steel brushed finish

ITEM	DESCRIPTION	UOM	CASE
TCHS-12MN	1-2 Slots	Each	12/96
TCHS-23MN	2-3 Slots	Each	12/72



### TACO HOLDERS

- ◆ Also useful for dressing hot dogs
- ◆ Can flip over to accommodate different quantities
- ◆ Stainless steel brushed finish

ITEM	DESCRIPTION	UOM	CASE
TCHS-12	1-2 Slots	Each	12/96
TCHS-23	2-3 Slots	Each	12/72
TCHS-34	3-4 Slots	Each	12/48
TCHS-45	4-5 Slots	Each	12/36



### COPPER-PLATED MOSCOW MULE MUGS

Whether serving its classic namesake drink or any refreshing cocktails, these rustic copper-plated mugs will instantly keep drinks extra cold, making them great additions to an outdoor bar setting.

ITEM	DESCRIPTION	UOM	CASE
CMM-20	20 Oz, Smooth Exterior	Each	36
CMM-20H	20 Oz, Hammered Exterior	Each	36

### MOSCOW MULE MUGS



CMM-20



CMM-20H

### MINI MOSCOW MULE MUGS

The popular Moscow Mule Mugs are now available in mini versions! Also great for sauces.

ITEM	DESCRIPTION	UOM	CASE
CMM-2	2 Oz, Smooth, 4-Pcs/Set	Set	6/24
CMM-2H	2 Oz, Hammered, 4-Pcs/Set	Set	6/24



CMM-2



CMM-2H

**LEAD-FREE  
BRASS  
HANDLES**

### STAINLESS STEEL MINT JULEP CUPS

ITEM	DESCRIPTION	UOM	CASE
DDSE-101S	3"Dia x 4-3/8"H	Each	12/72
DDSE-102S	3-3/8"Dia x 4-3/4"H	Each	12/72

### MINT JULEP CUPS



DDSE-101S

### STAINLESS STEEL MINI MILK CANS

ITEM	DESCRIPTION	UOM	CASE
DDSD-101S	2"Dia x 2"H	Each	12/144
DDSD-102S	2"Dia x 3-1/8"H	Each	12/72
DDSD-103S	3-1/8"Dia x 4"H	Each	12/36
DDSD-104S	3-1/8"Dia x 5"H	Each	12/36

### MINI MILK CANS & PAILS



DDSD-101S



DDSA-101S



DDSA-105S

### STAINLESS STEEL MINI PAILS

ITEM	DESCRIPTION	UOM	CASE
DDSA-101S	3"Dia x 3-1/8"H, Hammered	Each	12/72
DDSA-102S	3-1/2"Dia x 3-5/8"H, Hammered	Each	12/72
DDSA-103S	5"Dia x 5"H, Hammered	Each	12/48
DDSA-104S	3"Dia x 3-1/8"H	Each	12/72
DDSA-105S	3-1/2"Dia x 3-5/8"H	Each	12/72
DDSA-106S	3-3/4"Dia x 3-3/4"H	Each	12/72
DDSA-107S	5"Dia x 5"H	Each	12/48

### FRENCH PRESS

- ◆ Stainless steel frame with polypropylene handle
- ◆ Can also be used with loose leaf teas
- ◆ Glass carafe holds approximately 4 cups

ITEM	DESCRIPTION	UOM	CASE
FPCM-33	33 Oz, 3-3/4"Dia	Each	1/12

### COFFEE PRESS



FPCM-33

## SERVING TRAYS



DDSH-102S



DDSI-102S



DDSI-101S

## STAINLESS STEEL MINI SERVING PLATTERS

ITEM	DESCRIPTION	UOM	CASE
DDSH-101S	6-5/8"L x 4-1/4"W	Each	12/72
DDSH-102S	8-1/2"L x 5-1/4"W	Each	12/72

## STAINLESS STEEL LONG SERVING TRAYS

ITEM	DESCRIPTION	UOM	CASE
DDSI-101S	14-1/8"L x 3-1/2"W	Each	12/48
DDSI-102S	14-1/8"L x 7-1/2"W	Each	12/24

## WOODEN FRENCH BREAD BOARD

### WOODEN FRENCH BREAD BOARD

Perfect for serving fresh baked bread and hors d'oeuvres. Comfortable rounded serving handle built-in.

- ◆ Reversible design made of solid birch wood
- ◆ Hand wash recommended

ITEM	DESCRIPTION	UOM	CASE
WCB-225	22-1/2"L x 5-1/2"W x 3/4"H	Each	12



WCB-225



## SERVING BOARDS

### MARBLE & WOOD SERVING BOARDS

Add a rustic feel to any setting from buffets to sit-down dining. Ideal for serving cheeses, charcuterie, and other appetizers and desserts.

- ◆ The balance of white marble and acacia wood is perfect in both sophisticated and rustic settings
- ◆ Elegantly serve cheese plates, charcuterie and other hors d'oeuvres
- ◆ The cool surface is ideal for serving cheeses & fruits
- ◆ Hand wash only

ITEM	DESCRIPTION	UOM	CASE
SBMW-117	11-1/2" Overall Length	Each	1/6
SBMW-156	15-7/8" Overall Length	Each	1/6
SBMW-157	15-1/4" Overall Length	Each	1/6



SBMW-117  
9" X 7", 2-1/2" HANDLE



SBMW-156  
11-1/2" X 6", 4-3/8" HANDLE



SBMW-157  
10-3/4" X 7", 4-1/2" HANDLE



- ◆ Professional grade, ideal for high-end kitchens or for white linen tabletops
- ◆ Premium quality beechwood
- ◆ Durable carbon steel grinder for clean, sharp cuts
- ◆ Long-lasting stainless steel internal mechanisms

## MAESTRO GOURMET PEPPERMILLS

**winco**  
*Maestro*



WPM-6CD WPM-8CD WPM-10CD WPM-12CD



Durable carbon steel grinder for clean, sharp cuts



WPM-6K



WPM-8K

### MAESTRO MODERN

- ◆ Beautiful clean lines for upscale modern presentation

ITEM	DESCRIPTION	UOM	CASE
WPM-6CD	6"H	Each	1/48
WPM-8CD	8"H	Each	1/36
WPM-10CD	10"H	Each	1/24
WPM-12CD	12"H	Each	1/24

### MAESTRO REPLACEMENT KNOBS

ITEM	DESCRIPTION	UOM	CASE
WPM-6K	Knob for 6" Peppermills	Each	1/48
WPM-8K	Knob for 8" Peppermills	Each	1/48

### WOODEN PEPPERMILLS

- ◆ Rubberwood with zinc alloy grinder

ITEM	DESCRIPTION	UOM	CASE
WPM-08	8"H	Each	1/36
WPM-10	10"H	Each	1/24
WPM-12	12"H	Each	1/24
WPM-18	18"H	Each	1/12

## SALT & PEPPER



WPM-08 WPM-10 WPM-12 WPM-18

### SALT SHAKER & PEPPER GRINDER SET

- ◆ Rubberwood black matte finish
- ◆ 2-1/4" Dia x 6" H

ITEM	DESCRIPTION	UOM	CASE
SP-612	Salt & Pepper, 2-Pcs/Set	Set	1/24
SP-624	Pepper Mills, 2-Pcs/Set	Set	1/24



SP-612  
SALT & PEPPER

SP-624  
2 PEPPERMILLS



WPMP-6

### ACRYLIC PEPPERMILL/SALT SHAKER

ITEM	DESCRIPTION	UOM	CASE
WPMP-6	6"H	Each	1/72



## PLATTER SERVERS



FS-2

ISP-3

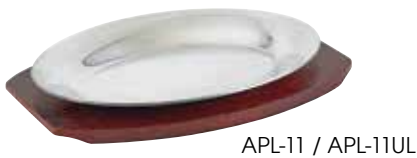

APL-11 / APL-11UL



SIZ-11ST

SIZ-11BST

## FAJITA SERVERS

- ◆ Improved plywood underliner resists splitting, chipping or cracking under the high-heat cast iron pan

ITEM	DESCRIPTION	UOM	CASE
FS-2	Fajita Server, 2-pc Set	Set	1/12
FS-2-UL	Replacement Underliner for FS-2, No Retail Pkg.	Each	12
ISP-3	Steak Platter with Gripper, 3-pc Set	Set	1/12
ISP-3-UL	Replacement Underliner for ISP-3, No Retail Pkg.	Each	12

- ◆ Wood underliner improved with layering construction
- ◆ Platter and underliner sold separately

## ALUMINUM SIZZLING PLATTERS

ITEM	DESCRIPTION	UOM	CASE
APL-10	10" Platter	Each	12/48
APL-10UL	Wood Underliner for APL-10	Each	12
APL-11	11" Platter	Each	12/48
APL-11UL	Wood Underliner for APL-11	Each	12
APL-12	12" Platter	Each	12/36
APL-12UL	Wood Underliner for APL-12	Each	12

## STAINLESS STEEL SIZZLING PLATTERS

ITEM	DESCRIPTION	UOM	CASE
SIZ-11ST	11" Platter & Underliner Set	Set	12
SIZ-11	11" Oval Platter, S/S	Each	12/60
SWU-11	Underliner for SIZ-11	Each	12/36
SIZ-11BST	11" x 7" Platter & Underliner Set	Set	12
SIZ-11B	11" x 7" Rectangular Platter, S/S	Each	12/60
SWU-11B	Underliner for SIZ-11B	Each	12/36

## OVAL PLATTERS



OPL-14

## STAINLESS STEEL OVAL PLATTERS

ITEM	DESCRIPTION	UOM	CASE
OPL-12	12" x 8-5/8"	Each	10/60
OPL-14	14" x 8-3/4"	Each	10/60
OPL-16	16" x 10-1/4"	Each	10/40
OPL-18	18" x 11-1/2"	Each	10/30
OPL-20	20" x 13-3/4"	Each	10/20
OPL-22	21-3/4" x 14-1/2"	Each	12

## AU GRATIN DISHES



ADO-12

## AU GRATIN DISHES

- ◆ Stainless steel

ITEM	DESCRIPTION	UOM	CASE
ADO-8	8 Oz	Each	12/120
ADO-12	12 Oz	Each	12/144
ADO-15	15 Oz	Each	12/120
ADO-20	20 Oz	Each	12/72

### TORTILLA PRESSES

- ◆ Traditional press with excellent leverage
- ◆ Integrated handle allows for easy open and removal of corn/flour tortillas
- ◆ Great for making burritos, enchiladas and quesadillas

ITEM	DESCRIPTION	WEIGHT	UOM	CASE
TPC-8A	8"Dia, Aluminum, Non-Stick	1.52Lbs	Each	6/12
TPC-8C	8"Dia, Cast Iron	7.94Lbs	Each	1/4



### TORTILLA SERVICE



TPC-8A



TPC-8C



PTW-8

NSF®

BPA FREE

### TORTILLA WARMER

- ◆ Easy grip recessed handle
- ◆ Serve tortillas warm and fresh

ITEM	DESCRIPTION	UOM	CASE
PTW-8	8-1/2"Dia x 2-5/8"H	Each	12

 Enhance South-of-the-Border dishes with our collection of Mexican-themed Molcajete salsa bowls and plate, tortilla warmer, and taco server. Made of BPA-free polypropylene, these rustic traditional style servers are break-resistant and dishwasher safe.

### MOLCAJETE SALSA BOWLS

- ◆ BPA-free

ITEM	DESCRIPTION	UOM	CASE
PMSB-4	4 Oz, 4-Pcs/Pk	Pack	24
PMSB-10	10 Oz, 4-Pcs/Pk	Pack	12
PMSB-56	56 Oz	Each	1/16

### SALSA & DIP SERVICE



PMSB-56

PMSB-10

PMSB-4  
PMSB-10

PMSB-SERIES

NSF®

BPA FREE

### MOLCAJETE SALSA PLATE

- ◆ BPA-free

ITEM	DESCRIPTION	UOM	CASE
PMP-12	12 Oz, 2-Pcs/Pk	Set	1/16



PMP-12

BPA FREE

## CONDIMENT HOLDERS



### BLACK WIRE CADDIES

ITEM	DESCRIPTION	UOM	CASE
WBKH-6SB	Flat Back, 8-1/4" x 6 1/4" x 9"H	Each	12
WBKH-6R	Round, 6-1/4"Dia x 9"H	Each	24
WBKH-7R	Round, 7-1/2"Dia x 9"H	Each	12



WBKH-6SB



WBKH-6R



WBKH-7R



WH-1

USE WITH PPH-SERIES, G-110, G-111



WH-2

### CHROME-PLATED HOLDERS



ITEM	DESCRIPTION	UOM	CASE
G-104S	Two 6 Oz Square Bottle Set w/Lids & Chrome-Plated Rack	Set	12
WH-1	Salt/Pepper Shakers & Sugar Packet Holder Rack (No Retail Pkg)	Each	12/48
WH-2	Sugar Packet Rack	Each	12/48
WH-3	Chrome-Plated Rack Holds 6 Oz Cruets (No Retail Pkg)	Each	12/48
WH-4	3-Ring Condiment Jar Rack	Each	12/48
WH-5	Rack Holds Two 6 Oz Sq Cruets	Each	12/72
WH-7	Salt/Pepper Shakers & Sugar Packets Rack	Each	12/72



G-104S  
USE WITH WH-3 AND  
(2) G-104



WH-3  
USE WITH G-104



WH-4  
USE WITH CJ-7P, CJ-7G



WH-5  
USE WITH G-104



WH-7  
USE WITH G-109



GOB-16S



GOB-8



WH-16

### OIL & VINEGAR CRUETS

*Also a great way to bottle and/or serve sauces and light syrups.*



ITEM	DESCRIPTION	UOM	CASE
GOB-8S	2 Square 8 Oz Oil Bottles w/Lid & Chrome-Plated Rack	Set	12
GOB-16S	2 Square 16 Oz Oil Bottles w/Lid & Chrome-Plated Rack	Set	12
GOB-8	Square 8 Oz Oil Bottle w/Lid	Each	24
GOB-16	Square 16 Oz Oil Bottle w/Lid	Each	12
WH-8	Chrome Plated Rack, Fits GOB-8	Each	48
WH-16	Chrome Plated Rack, Fits GOB-16	Each	24



**SALT & PEPPER REFILLER JUGS**

◆ Spring loaded spout allows for quick refill of salt and pepper shakers

ITEM	DESCRIPTION	UOM	CASE
PR-05P	1/2 Gal Pepper Refiller	Each	24
PR-05S	1/2 Gal Salt Refiller	Each	24

**SALT & PEPPER REFILLERS**



PR-05P

PR-05S

**GLASS SHAKERS**



G-100

G-101

G-102

G-103

G-104

G-105

G-106

G-3 SERIES  
ATTRACTIVE RETAIL  
PACKAGING  
CONTAINS  
12PCS/BOX\*



G-107

G-108

G-109

G-110

G-111

G-117

G-118

G-115

G-116



G-3 SERIES

DESCRIPTION	SIZE	UOM	WHOLESALE BOX PACKAGING		RETAIL BOX PACKAGING		REPLACEMENT TOPS FOR SHAKERS		
			ITEM	CASE	ITEM	CASE	ITEM	DESCRIPTION	CASE
Square Shakers, S/S Tops	1/2 Oz	Doz	G-100	1/48	G-300	1/48	G-100C	For G-100 / G-300 / G-110	24/144
Square Shakers, Brass Tops	1/2 Oz	Doz	G-101	1/48	G-301	1/48	G-101C	For G-101 / G-301 / G-111	24/144
Sugar Pourers, Flap Tops	12 Oz	Doz	G-102	1/4	G-302	1/4	G-102C	For G-102 / G-302	4/48
Sugar Pourers, Perf Tops	12 Oz	Doz	G-103	1/4	G-303	1/4	G-103C	For G-103 / G-303	4/48
Oil/Vinegar Cruets	6 Oz	Doz	G-104	1/6	G-304	1/6	G-104C	For G-104 / G-304	18/108
Paneled Shakers, Mushroom Tops	1 Oz	Doz	G-105	1/10	G-305	1/12	G-105C	For G-105 / G-305	24/120
Paneled Shakers, Mushroom Tops	2 Oz	Doz	G-106	1/10	G-306	1/12	G-106C	For G-106 / G-306	24/120
Cheese Shakers, Perf Tops	6 Oz	Doz	G-107	1/5	G-307	1/6	G-107C	For G-107 / G-307	5/90
Cheese Shakers, Slotted Tops	6 Oz	Doz	G-108	1/5			G-108C	For G-108 / G-308	5/90
Square Shakers, S/S Mushroom Tops	2 Oz	Doz	G-109	1/12	G-309	1/12	G-109C	For G-109 / G-308	12/96
Tower Shakers, S/S Tops	1 Oz	Doz	G-110	1/12	G-310	1/12			
Tower Shakers, Brass Tops	1 Oz	Doz	G-111	1/12	G-311	1/12			
Paneled Shakers, Mushroom Tops	3 Oz	Doz	G-117	1/12	G-317	1/12			
Classic Shakers, S/S Flat Tops	2 Oz	Doz	G-118	1/12					
Syrup Dispensers	6 Oz	(Doz/Box)	G-115	1/6					
Syrup Dispensers	14 Oz	(Doz/Box)	G-116	1/4	G-316 (4-Pcs/Box)	1/8			



## CONDIMENT DISPENSER



PKTS-2D



## CONDIMENT DISPENSER

*Ideal for busy bars, food stands, convenience stores or fast-food service. Removable plastic inserts allow for easy cleaning.*

- ◆ Durable 18/8 stainless steel, heavy duty pump
- ◆ Two (2) plastic inserts with 2 quart capacity
- ◆ Each pump full stroke draws out between 1 oz and 1-1/4 oz depending on viscosity
- ◆ Overall dimensions: 11"L x 8-3/4"W x 16"H (with pump)
- ◆ Assembly required

ITEM	DESCRIPTION	UOM	CASE
PKTS-2D	Condiment Dispenser with 2 Standard Pumps	Set	1/2
PKTS-PT01	Individual Pump with Lid	Each	1
PKTS-PT02	Replacement Plastic Jar	Each	1
PKTS-PT03	Stainless Steel Casing	Each	1

## SAUCE & DESSERT CUPS



FLUTED RFM-SERIES



PLAIN RP-SERIES



BLACK WHITE BONE



### MELAMINE RAMEKINS



## MELAMINE RAMEKINS

*With a variety of colors and sizes available, the break-resistant melamine ramekin cups are ideal for high volume, fast-paced foodservice environments.*

- ◆ NSF listed

ITEM	DESCRIPTION	SIZE	COLOR	UOM	CASE
RFM-1K	Fluted	1-1/2 Oz	Black	Doz	1/8
RFM-1W	Fluted	1-1/2 Oz	White	Doz	1/8
RFM-1B	Fluted	1-1/2 Oz	Bone	Doz	1/8
RFM-2K	Fluted	2 Oz	Black	Doz	1/8
RFM-2W	Fluted	2 Oz	White	Doz	1/8
RFM-2B	Fluted	2 Oz	Bone	Doz	1/8
RFM-3K	Fluted	3 Oz	Black	Doz	1/8
RFM-3W	Fluted	3 Oz	White	Doz	1/8
RFM-3B	Fluted	3 Oz	Bone	Doz	1/8
RFM-4K	Fluted	4 Oz	Black	Doz	1/8
RFM-4W	Fluted	4 Oz	White	Doz	1/8
RFM-4B	Fluted	4 Oz	Bone	Doz	1/8
RP-1K	Plain	1-1/2 Oz	Black	Doz	1/8
RP-1W	Plain	1-1/2 Oz	White	Doz	1/8
RP-1B	Plain	1-1/2 Oz	Bone	Doz	1/8
RP-2K	Plain	2 Oz	Black	Doz	1/8
RP-2W	Plain	2 Oz	White	Doz	1/8
RP-2B	Plain	2 Oz	Bone	Doz	1/8
RP-3K	Plain	3 Oz	Black	Doz	1/8
RP-3W	Plain	3 Oz	White	Doz	1/8
RP-3B	Plain	3 Oz	Bone	Doz	1/8
RP-4K	Plain	4 Oz	Black	Doz	1/8
RP-4W	Plain	4 Oz	White	Doz	1/8
RP-4B	Plain	4 Oz	Bone	Doz	1/8
RP-6K	Plain	6 Oz	Black	Doz	1/8
RP-6W	Plain	6 Oz	White	Doz	1/8
RP-6B	Plain	6 Oz	Bone	Doz	1/8



SCP-15

SCP-25

SCP-40

## STAINLESS STEEL SAUCE CUPS

ITEM	DESCRIPTION	UOM	CASE
SCP-15	1-1/2 Oz	Doz	1/48
SCP-25	2-1/2 Oz	Doz	1/48
SCP-40	4 Oz	Doz	1/48



PSN-2



ICC-5C



## SYRUP/CREAM PITCHER

- ◆ Durable SAN plastic
- ◆ BPA-free
- ◆ 24-Pcs/Pk

ITEM	DESCRIPTION	UOM	CASE
PSN-2	2 Oz Pitcher	Pack	6/12



## CLEAR ICE CREAM & BERRY DISH

- ◆ BPA-free

ITEM	DESCRIPTION	UOM	CASE
ICC-5C	SAN, 5 Oz	Doz	1/16

### GRAVY BOATS

◆ Stainless steel

ITEM	DESCRIPTION	UOM	CASE
GBS-3	3 Oz	Each	12/72
GBS-5	5 Oz	Each	12/48
GBS-8	8 Oz	Each	12/36
GBS-10	10 Oz	Each	12/36

### SERVERS/CREAMERS

◆ Stainless steel

ITEM	DESCRIPTION	UOM	CASE
SCT-10	10 Oz w/Knob	Each	12/120
SCT-10F	10 Oz, Stackable Cover	Each	12/120

### BELL CREAMERS

◆ Stainless steel

ITEM	DESCRIPTION	UOM	CASE
BCS-3	3 Oz	Each	12/144
BCS-5	5 Oz	Each	12/144
BCS-8	8 Oz	Each	12/144
BCS-10	10 Oz	Each	12/72

### SYRUP DISPENSERS & COLOR LIDS

- ◆ Stainless steel slide on lid prevents dripping
- ◆ PE bottles and interchangeable PP Lids
- ◆ Ideal for batter, dressing, juice and more



ITEM	DESCRIPTION	UOM	CASE
PSUD-32	32 Oz	Each	12
PSUD-48	48 Oz	Each	12
PSUD-WLid	Lid, White	Each	24/144
PSUD-RLid	Lid, Red	Each	24/144
PSUD-TLid	Lid, Tan	Each	24/144

## CONDIMENT SERVICE



GBS-10



SCT-10F



SCT-10



BCS-3



BCS-8



PSUD-48



PSUD-32



PSUD-RLID



PSUD-TLID



### STAINLESS STEEL SWEETENER PACKET HOLDERS

ITEM	DESCRIPTION	UOM	CASE
DDSG-101S	3-3/16"L x 2-5/8"W Tray	Each	12/144
DDSG-102S	1-3/4" Square Cup	Each	12/144
DDSG-103S	2"Dia Round Cup	Each	12/216
DDSG-301S	2"Dia Rnd & 2" Square Sugar Packet Holder Set	Each	12/60



DDSG-301S



### PLASTIC SWEETENER PACKET HOLDERS

- ◆ 3-1/2" L x 2-1/2" W x 2" H
- ◆ NSF listed

ITEM	DESCRIPTION	UOM	CASE
PPH-1C	Clear	Doz	1/6
PPH-1K	Black	Doz	1/6
PPH-1W	White	Doz	1/6



PPH-SERIES





## CONDIMENT SERVICE



SBR-30



T-710



SD-5



SBW-35



CJ-2C



CJ-PC



CJ-7P



CJ-7G



RS-4



### ROLL-TOP SUGAR BOWL

◆ Stainless steel

ITEM	DESCRIPTION	UOM	CASE
SBR-30	20 Oz	Each	1/24

### SUGAR CAN

◆ Stainless steel

ITEM	DESCRIPTION	UOM	CASE
T-710	10 Oz	Each	1/72

### SHERBET DISHES

◆ Stainless steel

ITEM	DESCRIPTION	UOM	CASE
SD-3	3-1/2 Oz	Each	12/120
SD-5	5 Oz	Each	12/120

### BUTTER WARMER

◆ Set includes stand, butter cup, candle holder and candle

ITEM	DESCRIPTION	UOM	CASE
SBW-35	4-Pc Set	Set	1/48

### CONDIMENT JARS & COVERS

ITEM	DESCRIPTION	UOM	CASE
CJ-7P	7 Oz Jar, Plastic	Doz	1/6
CJ-2C	Slotted Cover for CJ-7P, S/S	Each	36/144
CJ-7G	7 Oz Jar, Glass	Doz	3
CJ-PC	Slotted Cover for CJ-7G, Plastic	Doz	24

### RELISH SERVERS



ITEM	DESCRIPTION	UOM	CASE
RS-3	3 Compartments	Set	1/24
RS-4	4 Compartments	Set	1/24

## SNAIL SERVICE



SND-6

### SNAIL SERVICE

◆ Neatly serve escargot

◆ Stainless steel

ITEM	DESCRIPTION	UOM	CASE
SND-6	Dish, 6 Holes	Each	12/144
SND-T6	Tong	Each	12/120
SND-F7	Fork	Doz	1/50



SND-T6



SND-F7

## SEAFOOD TRAYS

Create an enticing tabletop spread with these trays in assorted sizes for displaying shrimp, seafood or tasty appetizers. The brushed aluminum construction retains cold and keeps foods at safe serving temperatures.

ITEM	DESCRIPTION	UOM	CASE
ASFT-12	12"Dia x 1-1/2"H	Each	12/36
ASFT-14	13-3/4"Dia x 1-1/2"H	Each	12/36
ASFT-16	15-3/4"Dia x 1-1/2"H	Each	12/24
ASFT-18	17-3/4"Dia x 1-1/2"H	Each	12/24
ASFT-20	19-3/4"Dia x 1-1/2"H	Each	12

## SEAFOOD TRAYS



ASFT-12

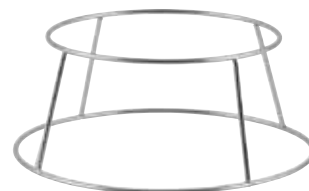

SFR-4



### CHROME-PLATED SEAFOOD TRAY RACKS

- ◆ Use with ASFT-series seafood trays to create appealing tabletop presentations
- ◆ Also perfect for elevating serving plates, bowls and platters, as well as holding pizza pans

ITEM	DESCRIPTION	UOM	CASE
SFR-4	7-3/8" Top Dia / 9-5/8" Bottom Dia x 4-3/8"H	Each	1/20
SFR-7	7-3/8" Top Dia / 9-5/8" Bottom Dia x 7"H	Each	1/20

## PEARL SHELL BOWLS

Made of light-weight ABS plastic, these shell bowls are ideal for displaying cold foods and salads.

ITEM	DESCRIPTION	UOM	CASE
PSBW-1W	20 Oz	Each	12/48
PSBW-5W	5 Qt	Each	6/12

## SALAD BOWLS



PSBW-1W

PSBW-5W

### PEBBLED SALAD BOWLS

- ◆ Made of durable polycarbonate, these clear pebbled bowls are perfect for salads, fruits, desserts and snacks
- ◆ NSF listed

ITEM	DESCRIPTION	UOM	CASE
PBB-6	6"	Each	96
PBB-8	8"	Each	48
PBB-10	10"	Each	24
PBB-12	12"	Each	24
PBB-15	15"	Each	12
PBB-18	18"	Each	12



PBB-10

PBB-SERIES 

### WOODEN SALAD BOWLS

- ◆ Hand wash only
- ◆ Also good for chips and snacks

ITEM	DESCRIPTION	UOM	CASE
WWB-5	5"	Each	12/288
WWB-6	6"	Each	12/288
WWB-8	8"	Each	12/144
WWB-10	10"	Each	12/96
WWB-12	12"	Each	12/72
WWB-14	14"	Each	12/36
WWB-16	16"	Each	12/24
WWB-18	18"	Each	12
WWB-20	20"	Each	12



WWB-SERIES



## TABLETOP BASKETS



PWBN-118T



PWBK-1914T

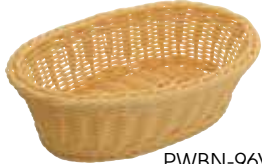

PWBN-96V

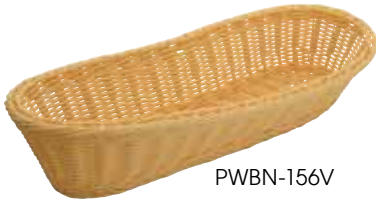

PWBN-156V



PWBK-88R



PWBK-94B



PWBN-SERIES



PWBN-16B



PWBK-SERIES



## SOLID-CORD POLY WOVEN BASKETS

- ◆ Flexible with reinforced weaving on rim and base for added durability
- ◆ Easily stackable
- ◆ Dishwasher safe

ITEM	DESCRIPTION	SIZE	COLOR	UOM	CASE
PWBK-118T	Rectangular, 12-Pcs/Pk	11-1/2" x 8-1/2" x 3-1/2"	Black	Pack	1/2
PWBN-118T	Rectangular, 12-Pcs/Pk	11-1/2" x 8-1/2" x 3-1/2"	Natural	Pack	1/2
PWBK-1914T	Rectangular with Handles, 3-Pcs/Pk	19" x 14" x 4"	Black	Pack	1/4
PWBN-1914T	Rectangular with Handles, 3-Pcs/Pk	19" x 14" x 4"	Natural	Pack	1/4
PWBK-96V	Oval, 6-Pcs/Pk	9-1/4" x 6-1/4" x 3-1/4"	Black	Pack	1/12
PWBN-96V	Oval, 6-Pcs/Pk	9-1/4" x 6-1/4" x 3-1/4"	Natural	Pack	1/12
PWBK-156V	Oval, 6-Pcs/Pk	15" x 6-1/2" x 3-1/4"	Black	Pack	1/6
PWBN-156V	Oval, 6-Pcs/Pk	15" x 6-1/2" x 3-1/4"	Natural	Pack	1/6
PWBK-88R	Round, 12-Pcs/Pk	8-1/4" x 3-1/4"	Black	Pack	1/3
PWBN-88R	Round, 12-Pcs/Pk	8-1/4" x 3-1/4"	Natural	Pack	1/3
PWBK-94B	Oval, 6-Pcs/Pk	9" x 4-1/2" x 3"	Black	Pack	1/12
PWBN-94B	Oval, 6-Pcs/Pk	9" x 4-1/2" x 3"	Natural	Pack	1/12

## TAN POLY WOVEN BASKETS

ITEM	DESCRIPTION	SIZE	UOM	CASE
PWBN-9B	Long Oval	9" x 4-1/4" x 2"	Doz	1/12
PWBN-9R	Round	9" x 2-3/4"	Doz	1/12
PWBN-9V	Oval	9-1/2" x 6-1/2" x 2-3/4"	Doz	1/12

## NATURAL WOVEN BASKETS

ITEM	DESCRIPTION	SIZE	UOM	CASE
PWBN-12B	Rectangle with Handles	12" x 8" x 3"	Each	12/96
PWBN-16B	Rectangle with Handles	16" x 11" x 3"	Each	12/48

## BLACK/GOLD POLY WOVEN BASKETS

- ◆ Wire reinforced

ITEM	DESCRIPTION	SIZE	UOM	CASE
PWBK-8R	Round	8-1/4" x 2-1/4"	Doz	1/12
PWBK-9B	Long Oval	8-3/4" x 3-7/8" x 2"	Doz	1/12
PWBK-9V	Oval	9" x 7" x 2-3/4"	Doz	1/12



**BREAD BASKETS**

ITEM	DESCRIPTION	SIZE	UOM	CASE
WBKG-9	Rectangular	9" x 5-7/8" x 3"	Each	24
WBKG-8R	Round	8"	Each	48
WBKG-10O	Oval	10" x 6-1/2" x 3"	Each	24
WBKG-10R	Round	10"	Each	12
WBKG-15	Long Oval	15" x 6-1/4" x 3"	Each	12

**BLACK WIRE SERVING BASKETS**



WBKG-9



WBKG-10O



WBKG-15



WBKG-10R

**PLASTIC OVAL PLATTERS**

- ◆ Sturdy BPA-free poly plastic
- ◆ Great for bread, appetizers, sandwiches and fries
- ◆ Dishwasher safe
- ◆ NSF listed

ITEM	DESCRIPTION (L X W X H)	COLOR	UOM	CASE
PLB-G	10-3/4" x 7-1/4" x 1-1/2"	Green	Doz	12
PLB-K	10-3/4" x 7-1/4" x 1-1/2"	Black	Doz	12
PLB-R	10-3/4" x 7-1/4" x 1-1/2"	Red	Doz	12
PLB-Y	10-3/4" x 7-1/4" x 1-1/2"	Yellow	Doz	12

**FAST FOOD BASKETS**



PLB-SERIES **NSF**  
**BPA FREE**

**PREMIUM PLASTIC OVAL BASKETS**

- ◆ Sturdy BPA-free poly plastic
- ◆ Great for fast dining establishments
- ◆ Choice of five (5) colors
- ◆ Dishwasher safe

ITEM	DESCRIPTION (L X W X H)	COLOR	UOM	CASE
POB-G	10-1/4" x 6-3/4" x 2"	Green	Doz	12
POB-K	10-1/4" x 6-3/4" x 2"	Black	Doz	12
POB-R	10-1/4" x 6-3/4" x 2"	Red	Doz	12
POB-Y	10-1/4" x 6-3/4" x 2"	Yellow	Doz	12
PFB-10B	9-1/2" x 5" x 2"	Brown	Doz	3
PFB-10G	9-1/2" x 5" x 2"	Green	Doz	3
PFB-10R	9-1/2" x 5" x 2"	Red	Doz	3



POB-SERIES **NSF**  
**BPA FREE**



PFB-SERIES **BPA FREE**

## MENU COVERS



Full size menu cover styles available in 3 colors

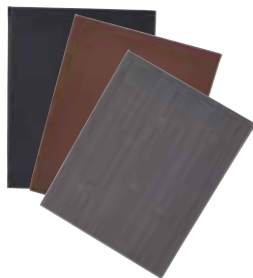

Chic leatherette menu covers provide an elegant yet durable display for full-service or fast casual restaurants alike. The refined double-sided stitched menu covers offer the look of a customized menu without the customization wait times - a timeless style in a full collection to complement any décor.

- ◆ Features secure interior picture corners
- ◆ Available for both letter and legal size pages
- ◆ Three neutral color choices and patterns
- ◆ Most common sizes and page configurations available



LMS-814BK  
Bar size

LMS-814GY  
Legal size

LMS-811GY  
Letter size



Picture corners

### SINGLE-VIEW MENU COVERS

- ◆ Great for lunch or tapas menus, drink specials and desserts
- ◆ LMS-414BK fits 4-1/2" x 14" paper
- ◆ LMS-811 series fits 8-1/2" x 11" letter size paper
- ◆ LMS-814 series fits 8-1/2" x 14" legal size paper

ITEM	DESCRIPTION	COLOR	UOM	CASE
LMS-811BK	Letter Size	Black	Each	1/50
LMS-811BN	Letter Size	Brown	Each	1/50
LMS-811GY	Letter Size	Gray	Each	1/50
LMS-814BK	Legal Size	Black	Each	1/50
LMS-814BN	Legal Size	Brown	Each	1/50
LMS-814GY	Legal Size	Gray	Each	1/50
LMS-414BK	Bar Size	Black	Each	1/50

### TWO-VIEW MENU COVERS

- ◆ Perfect for most upscale dinner menus highlighting the finest of chef's creations
- ◆ LMD-811 series fits 8-1/2" x 11" letter size paper
- ◆ LMD-814 series fits 8-1/2" x 14" legal size paper

ITEM	DESCRIPTION	COLOR	UOM	CASE
LMD-811BK	Letter Size	Black	Each	1/30
LMD-811BN	Letter Size	Brown	Each	1/30
LMD-811GY	Letter Size	Gray	Each	1/30
LMD-814BK	Legal Size	Black	Each	1/30
LMD-814BN	Legal Size	Brown	Each	1/30
LMD-814GY	Legal Size	Gray	Each	1/30



LMD-814BK  
Two-view  
Legal size

### FOUR-VIEW MENU COVERS

- ◆ Ideal for most casual restaurant establishments with an extensive variety of menu items
- ◆ LMF-811 series fits 8-1/2" x 11" letter size paper
- ◆ LMF-814 series fits 8-1/2" x 14" legal size paper

ITEM	DESCRIPTION	COLOR	UOM	CASE
LMF-811BK	Letter Size	Black	Each	1/30
LMF-811BN	Letter Size	Brown	Each	1/30
LMF-811GY	Letter Size	Gray	Each	1/30
LMF-814BK	Legal Size	Black	Each	1/30
LMF-814BN	Legal Size	Brown	Each	1/30
LMF-814GY	Legal Size	Gray	Each	1/30



LMF-814GY  
Four-view  
Legal size

### MENU TENTS

- ◆ Highlight specials or drinks with either our dual or 3-sided tent menus
- ◆ Easily change out promotional menus on these durable tabletop holders
- ◆ 5" x 7" paper fits in menu tents

ITEM	DESCRIPTION	UOM	CASE
LMTD-57BK	Dual-View	Each	50
LMTT-57BK	Triple-View	Each	50



LMTD-57BK



LMTT-57BK

The edgings on all Winco® menu covers are double stitched to hold up to the wear and tear of constant, daily handling.

## MENU COVERS & HOLDERS

ALL CLEAR PAGES

### SINGLE POCKET MENU COVERS

- ◆ PMC-5 series fits 5" x 8" paper
- ◆ PMC-9 series fits 8-1/2" x 11" paper
- ◆ PMC-14 series fits 8-1/2" x 14" paper

ITEM	DESCRIPTION	UOM	CASE
PMC-5K	Black 6-3/8" x 9-3/8"	Each	25/200
PMC-5U	Burgundy 6-3/8" x 9-3/8"	Each	25/200
PMC-9B	Blue 9-5/16" x 12-1/8"	Each	25/200
PMC-9K	Black 9-5/16" x 12-1/8"	Each	25/200
PMC-9R	Red 9-5/16" x 12-1/8"	Each	25/200
PMC-9U	Burgundy 9-5/16" x 12-1/8"	Each	25/200
PMC-9G	Green 9-5/16" x 12-1/8"	Each	25/200
PMC-14K	Black 9-3/8" x 14-7/8"	Each	25/100
PMC-14U	Burgundy 9-3/8" x 14-7/8"	Each	25/100



PMC-SERIES

### BOOK-FOLD DOUBLE PANEL MENU COVERS

- ◆ PMCD-9 series fits 8-1/2" x 11" paper
- ◆ PMCD-14 series fits 8-1/2" x 14" paper

ITEM	DESCRIPTION	UOM	CASE
PMCD-9B	Blue 9-3/8" x 12-1/8"	Each	25/100
PMCD-9K	Black 9-3/8" x 12-1/8"	Each	25/100
PMCD-9R	Red 9-3/8" x 12-1/8"	Each	25/100
PMCD-9U	Burgundy 9-3/8" x 12-1/8"	Each	25/100
PMCD-9G	Green 9-3/8" x 12-1/8"	Each	25/100
PMCD-14K	Black 9-9/16" x 15"	Each	25/100
PMCD-14U	Burgundy 9-9/16" x 15"	Each	25/100

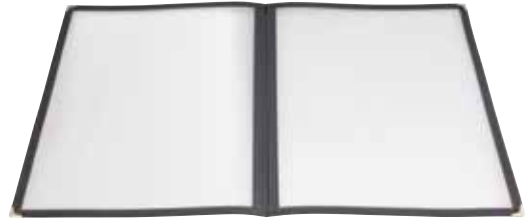

PMCD-9K

### TRI-FOLD TRIPLE PANEL MENU COVERS

- ◆ PMCT-9 fits 8-1/2" x 11" paper

ITEM	DESCRIPTION	UOM	CASE
PMCT-9B	Blue 9-1/2" x 12-1/8"	Each	25/50
PMCT-9K	Black 9-1/2" x 12-1/8"	Each	25/50
PMCT-9R	Red 9-1/2" x 12-1/8"	Each	25/50
PMCT-9G	Green 9-1/2" x 12-1/8"	Each	25/50
PMCT-9U	Burgundy 9-1/2" x 12-1/8"	Each	25/50



PMCT-9K

### FOUR POCKET BLACK MENU COVER

- ◆ PMCF-9 fits 8-1/2" x 11" paper

ITEM	DESCRIPTION	UOM	CASE
PMCF-9K	9-5/8" x 12-1/8"	Each	25/50



PMCF-9K

### DOUBLE SIDED CLEAR ACRYLIC MENU STANDS

- ◆ 2.0mm thickness

ITEM	DESCRIPTION	UOM	CASE
ATCH-46	4" x 6"	Each	12/36
ATCH-53	5-1/2" x 3-1/2"	Each	12/48
ATCH-57	5" x 7"	Each	12/36
ATCH-811	8" x 11"	Each	12/24



ATCH-811



## SIGN CLIPS & HOLDERS



TBH-12



TBN-SERIES



MH-1



MH-2



MH-2C



TCD-2



TCD-3C



TCD-3S



TCD-4D



TCD-4S



TCD-4T

## TABLE NUMBER HOLDERS

◆ Mirror finish chrome-plated steel

ITEM	DESCRIPTION	UOM	CASE
TBH-8	8"	Each	12/120
TBH-12	12"	Each	12/120
TBH-15	15"	Each	12/120
TBH-18	18"	Each	12/120

## PLASTIC TABLE NUMBERS

◆ Numbers printed on both sides

◆ Measures 4" x 3-3/4"

ITEM	DESCRIPTION	UOM	CASE
TBN-25	Numbers 1-25	Set	1/200
TBN-50	Numbers 1-50	Set	1/100
TBN-100	Numbers 1-100	Set	1/50

## MENU HOLDER CLIPS

ITEM	DESCRIPTION	UOM	CASE
MH-1	Harp Clip, Heavy-Cast Base, 1"L x 1"W x 1-1/2"H	Doz	10/60
MH-2	Ring-Type, 2-1/2" x 2-1/3"	Doz	2/20
MH-2C	Clip, 2-1/2" x 2-1/2"	Doz	1/40



## TABLE SIGN HOLDERS

*Stylish and discreet, these table sign holders are perfect for buffet and table seating.*

ITEM	DESCRIPTION	UOM	CASE
TCD-2	Table Sign Holder, Cast Aluminum, 2-Pcs/Pk	Pack	24/240
TCD-3C	Table Sign Clip, "C" Base, 6-Pcs/Pk	Pack	4/96
TCD-3S	Table Sign Clip, "S" Base, 6-Pcs/Pk	Pack	4/96
TCD-4D	Table Sign Clip, Double Sided Clips, Flexible, 6-Pcs/Pk	Pack	48/192
TCD-4S	Table Sign Clip, Acrylic Square Base, 6-Pcs/Pk	Pack	4/48
TCD-4T	Table Sign Clip, Acrylic Triangle Base, 6-Pcs/Pk	Pack	4/48

## WINE SERVICE

### 4 QT WINE BUCKETS & STAND

- ◆ Stainless steel mirror finish

ITEM	DESCRIPTION	SIZE	UOM	CASE
WB-4	4 Qt Wine Bucket, No Retail Pkg.	7-1/2" Dia x 8" H	Each	6/24
WB-4HV	4 Qt Deluxe Wine Bucket	8" Dia x 10" H	Each	1/12
WB-29S	Pipe Style Stand for WB-4 & WB-4HV	28-1/2" H	Each	1/6



WB-4



WB-4HV



WB-29S

### 8 QT WINE BUCKET & STANDS

- ◆ Stainless steel mirror finish

ITEM	DESCRIPTION	UOM	CASE
WB-8	8 Qt Wine Bucket*	Each	6/24
WB-8S	Stand for WB-8	Each	1/12
WB-12FS	Folding Stand for WB-8	Each	1/6

\*Assembly required

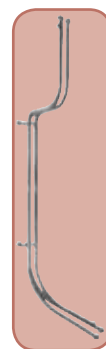

WB-12FS  
Folded



WB-12FS  
OPEN



WB-8 & WB-8S

### DOUBLE WALL WINE COASTERS

- ◆ Great space saving alternative to wine buckets
- ◆ Can also be used to display light snacks, hors d'oeuvres or desserts on tabletops
- ◆ Satin finish stainless steel
- ◆ Fits 3-3/4" diameter wine bottles

ITEM	DESCRIPTION	SIZE	UOM	CASE
DWCC-5	Smooth Finish	4-5/8" Dia x 2-5/8"H	Each	12
DWCC-5H	Hammered Finish	4-5/8" Dia x 2-5/8"H	Each	12



DWCC-5



DWCC-5H

### WINE COOLERS

ITEM	DESCRIPTION	SIZE	COLOR	UOM	CASE
WC-60	Double Wall Hourglass, Mirror S/S	6" Dia x 7" H		Each	1/12
WC-7M	Marble	4 1/2" Dia x 7" H	White	Each	1/6
WC-5	Double Wall, Satin S/S, No Retail Pkg.	4 1/2" Dia x 7-3/4" H		Each	6/24
WC-4A	Acrylic	4 1/2" Dia x 9 1/4" H	Clear	Each	1/12



WC-60



WC-7M



WC-5



WC-4A

## NON-SLIP SERVING TRAYS



TFG-16N

TFG-2622K

**NSF** TFG FIBERGLASS SERIES



## DELUXE FIBERGLASS TRAYS

- ◆ High durability fiberglass tray with self-molded peel-resistant non-slip surface
- ◆ Easy to wash by hand, however not recommended to leave soaking in hot water
- ◆ NSF listed

ITEM	DESCRIPTION	SIZE	COLOR	UOM	CASE
TFG-11K	Round	11"	Black	Each	1/12
TFG-11N	Round	11"	Brown	Each	1/12
TFG-14K	Round	14"	Black	Each	1/12
TFG-14N	Round	14"	Brown	Each	1/12
TFG-16K	Round	16"	Black	Each	1/12
TFG-16N	Round	16"	Brown	Each	1/12
TFG-2622K	Oval	26"x 22"	Black	Each	1/6
TFG-2622N	Oval	26"x 22"	Brown	Each	1/6



TRH-16

TRH-2722K

**NSF** TRH PLASTIC SERIES

## EASY-HOLD RUBBER-LINED PLASTIC TRAYS

- ◆ NSF listed

ITEM	DESCRIPTION	SIZE	COLOR	UOM	CASE
TRH-11	Round	11"	Brown	Each	12
TRH-11K	Round	11"	Black	Each	12
TRH-14	Round	14"	Brown	Each	12
TRH-14K	Round	14"	Black	Each	12
TRH-16	Round	16"	Brown	Each	12
TRH-16K	Round	16"	Black	Each	12
TRH-1418	Rectangular	14"x 18"	Brown	Each	12
TRH-1418K	Rectangular	14"x 18"	Black	Each	12
TRH-2722	Oval	22"x 27"	Brown	Each	1/6
TRH-2722K	Oval	22"x 27"	Black	Each	1/6



TCK-16

## PLASTIC CORK-LINED TRAYS

ITEM	DESCRIPTION	SIZE	UOM	CASE
TCK-14	Round	14"	Each	12/48
TCK-16	Round	16"	Each	12/36
TCK-14CK	Replacement Cork for TCK-14		Each	50/350
TCK-16CK	Replacement Cork for TCK-16		Each	50/350

## TRAY STANDS



TSY-1A

TR-33W

TR-34W

## TRAY STANDS

ITEM	DESCRIPTION	SIZE	UOM	CASE
TSY-1A	Chrome Steel	31"	Each	6
TR-33W	Rubberwood, Walnut	32"	Each	1
TR-34W	Rubberwood, Mahogany	32"	Each	1



### SERVING TRAYS

Made of highly polished stainless steel, these round trays feature a whimsical swirl design, adding a modern flair to even the most traditional drink presentations.

ITEM	DESCRIPTION	SIZE	UOM	CASE
STRS-12	Round	12"	Each	12/48
STRS-14	Round	14"	Each	12/24
STRS-16	Round	16"	Each	12/24

### SERVING TRAYS



STRS-14

### CHROME SERVING TRAYS

The classic gadroon edge and traditional engraving of these chrome-plated trays are perfect for tea and coffee service, as well as pastries, appetizers and desserts.

- ◆ Available in a variety of shapes and sizes
- ◆ Not recommended for prolonged use with meat or acidic ingredients
- ◆ Hand wash only

ITEM	DESCRIPTION	SIZE	UOM	CASE
CMT-1912	Rectangular w/Handles	19-1/2" x 12-1/2"	Each	12/24
CMT-1217	Octagonal	17" x 12-1/2"	Each	12/24
CMT-1420	Octagonal	20" x 14"	Each	12/24
CMT-1812	Rectangular	18" x 12-1/2"	Each	12/24
CMT-2014	Rectangular	20" x 14"	Each	12/24
CMT-1014	Oval	14-3/4" x 10-1/2"	Each	12/24
CMT-1318	Oval	18-3/4" x 13"	Each	12/24
CMT-14	Round	14"	Each	12/24

### CHROME SERVING TRAYS



CMT-1912



CMT-1420



CMT-2014



CMT-14



CMT-1318

### PLATTERS

- ◆ Stainless steel

ITEM	DESCRIPTION	SIZE	UOM	CASE
OPL-12	Oval	11-3/4" x 7-7/8"	Each	10/60
OPL-14	Oval	13-5/8" x 9-1/2"	Each	10/60
OPL-16	Oval	15-7/8" x 10-1/2"	Each	10/40
OPL-18	Oval	17-7/8" x 12-1/4"	Each	10/30
OPL-20	Oval	19-5/8" x 13-1/2"	Each	10/20
OPL-22	Oval	21-5/8" x 15"	Each	12

### OVAL PLATTERS



OPL-14

## DINING TRAYS



Reinforced bottom

**3** POPULAR SIZES  
**7** GREAT COLORS



**NSF** **BPA FREE** FFT-SERIES



**NSF** FGT-SERIES



Reinforced to prevent warping

Available tray colors:

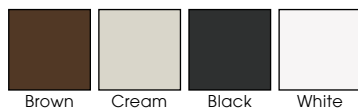

**MOLDED-IN LUGS ALLOW FOR QUICK DRYING**



**NSF** FGTT-SERIES

## HIGH QUALITY PLASTIC CAFETERIA TRAYS

- ◆ Resists warping with frequent use
- ◆ NSF listed

ITEM	DESCRIPTION	COLOR	UOM	CASE
FFT-1014B	10" x 14"	Brown	Each	12/48
FFT-1014E	10" x 14"	Grey	Each	12/48
FFT-1014G	10" x 14"	Green	Each	12/48
FFT-1014K	10" x 14"	Black	Each	12/48
FFT-1014O	10" x 14"	Orange	Each	12/48
FFT-1014R	10" x 14"	Red	Each	12/48
FFT-1014U	10" x 14"	Burgundy	Each	12/48
FFT-1216B	12" x 16"	Brown	Each	12/48
FFT-1216E	12" x 16"	Grey	Each	12/48
FFT-1216G	12" x 16"	Green	Each	12/48
FFT-1216K	12" x 16"	Black	Each	12/48
FFT-1216O	12" x 16"	Orange	Each	12/48
FFT-1216R	12" x 16"	Red	Each	12/48
FFT-1216U	12" x 16"	Burgundy	Each	12/48
FFT-1418B	14" x 18"	Brown	Each	12/48
FFT-1418E	14" x 18"	Grey	Each	12/48
FFT-1418G	14" x 18"	Green	Each	12/48
FFT-1418K	14" x 18"	Black	Each	12/48
FFT-1418O	14" x 18"	Orange	Each	12/48
FFT-1418R	14" x 18"	Red	Each	12/48
FFT-1418U	14" x 18"	Burgundy	Each	12/48

## FIBERGLASS RECTANGULAR DINING TRAYS

- ◆ Multi-purpose rectangular trays are perfect for any setting
- ◆ Long-lasting heavy-weight trays last through years of high-traffic use
- ◆ NSF listed

ITEM	DESCRIPTION	COLOR	UOM	CASE
FGT-1216B	12" x 16"	Brown	Each	12
FGT-1216C	12" x 16"	Cream	Each	12
FGT-1216K	12" x 16"	Black	Each	12
FGT-1216W	12" x 16"	White	Each	12
FGT-1418B	14" x 18"	Brown	Each	12
FGT-1418C	14" x 18"	Cream	Each	12
FGT-1418K	14" x 18"	Black	Each	12
FGT-1418W	14" x 18"	White	Each	12
FGT-1520B	15" x 20"	Brown	Each	12
FGT-1520K	15" x 20"	Black	Each	12
FGT-1520W	15" x 20"	White	Each	12

## FIBERGLASS TRAPEZOID DINING TRAYS

- ◆ Trapezoid trays are ideal for tabletops with limited space
- ◆ Long-lasting heavy-weight trays last through years of high-traffic use
- ◆ NSF listed

ITEM	DESCRIPTION	COLOR	UOM	CASE
FGTT-1814B	18" x 14"	Brown	Each	12
FGTT-1814C	18" x 14"	Cream	Each	12
FGTT-1814K	18" x 14"	Black	Each	12
FGTT-1814W	18" x 14"	White	Each	12

## ALUMINUM SERVING TRAYS

Winco's aluminum sheet pans are not only a baker's default tool for all functions, but are also ideal as serving trays to complement any rustic table setting.

- ◆ Closed bead with galvanized wire for rust resistance and reinforcement (1/4 and 1/2 size)
- ◆ Made of 3003 aluminum

ITEM	DESCRIPTION	SIZE	GAUGE	UOM	CASE
ALXP-0609	6" x 9"	1/8-Size	16	Each	24
ALXP-1013	9-1/2" x 13"	1/4-Size	20	Each	24
ALXP-1318	13" x 18"	1/2-Size	20	Each	12

SEE PAGE 200 FOR MORE SHEET PANS



ALXP-0609

## 6 COMPARTMENT MESS TRAYS

- ◆ Stainless steel mirror finish and dishwasher safe

ITEM	DESCRIPTION	UOM	CASE
SMT-1	15-1/2" x 11-1/2"	Each	24
SMT-2	15-1/2" x 11-1/2"	Each	24



SMT-1



SMT-2

## PLASTIC OVAL PLATTERS

- ◆ Sturdy BPA-free poly plastic
- ◆ Great for bread, appetizers, sandwiches and fries
- ◆ Dishwasher safe
- ◆ NSF listed

ITEM	DESCRIPTION	COLOR	UOM	CASE
PLB-G	10-3/4" x 7-1/4" x 1-1/2"	Green	Doz	12
PLB-K	10-3/4" x 7-1/4" x 1-1/2"	Black	Doz	12
PLB-R	10-3/4" x 7-1/4" x 1-1/2"	Red	Doz	12
PLB-Y	10-3/4" x 7-1/4" x 1-1/2"	Yellow	Doz	12

## FAST FOOD BASKETS



PLB-SERIES

NSF

BPA FREE

## PREMIUM PLASTIC OVAL BASKETS

- ◆ Sturdy BPA-free poly plastic
- ◆ Great for fast dining establishments
- ◆ Choice of five different colors
- ◆ Dishwasher safe

ITEM	DESCRIPTION	COLOR	UOM	CASE
POB-G	10-1/4" x 6-3/4" x 2"	Green	Doz	12
POB-K	10-1/4" x 6-3/4" x 2"	Black	Doz	12
POB-R	10-1/4" x 6-3/4" x 2"	Red	Doz	12
POB-Y	10-1/4" x 6-3/4" x 2"	Yellow	Doz	12
PFB-10B	9-1/2" x 5" x 2"	Brown	Doz	3
PFB-10G	9-1/2" x 5" x 2"	Green	Doz	3
PFB-10R	9-1/2" x 5" x 2"	Red	Doz	3



POB-SERIES

NSF

BPA FREE



PFB-SERIES

BPA FREE



## CONDIMENT DISPENSER



PKTS-2D



## CONDIMENT DISPENSER

Ideal for busy bars, food stands, convenience stores or fast-food service. Removable plastic inserts allow for easy cleaning.

- ◆ Durable 18/8 stainless steel, heavy duty pump
- ◆ Two (2) plastic inserts with 2 quart capacity
- ◆ Each pump full stroke draws out between 1 oz and 1-1/4 oz depending on viscosity
- ◆ Overall dimensions: 11"L x 8-3/4"W x 16"H (with pump)
- ◆ Assembly required

ITEM	DESCRIPTION	UOM	CASE
PKTS-2D	Condiment Dispenser with 2 Standard Pumps	Set	1/2
PKTS-PT01	Individual Pump with Lid	Each	1
PKTS-PT02	Replacement Plastic Jar	Each	1
PKTS-PT03	Stainless Steel Casing	Each	1

## SQUEEZE BOTTLES



PSW-24



Wide-mouth squeeze bottle



6 per pack

BPA FREE

PSW-SERIES

- ◆ Open tip, no need for cutting
- ◆ Each pack contains six (6) pieces
- ◆ BPA-free

## WIDE-MOUTH SQUEEZE BOTTLES

ITEM	DESCRIPTION	COLOR	UOM	CASE
PSW-12	12 Oz	Clear	Pack	1/12
PSW-12R	12 Oz	Red	Pack	1/12
PSW-12Y	12 Oz	Yellow	Pack	1/12
PSW-16	16 Oz	Clear	Pack	1/8
PSW-16R	16 Oz	Red	Pack	1/8
PSW-16Y	16 Oz	Yellow	Pack	1/8
PSW-24	24 Oz	Clear	Pack	1/8
PSW-24R	24 Oz	Red	Pack	1/8
PSW-24Y	24 Oz	Yellow	Pack	1/8
PSW-32	32 Oz	Clear	Pack	1/6
PSW-32R	32 Oz	Red	Pack	1/6
PSW-32Y	32 Oz	Yellow	Pack	1/6

## REGULAR SQUEEZE BOTTLES

ITEM	DESCRIPTION	COLOR	UOM	CASE
PSB-08C	8 Oz	Clear	Pack	12
PSB-08R	8 Oz	Red	Pack	1/12
PSB-08Y	8 Oz	Yellow	Pack	1/12
PSB-12C	12 Oz	Clear	Pack	1/12
PSB-12R	12 Oz	Red	Pack	1/12
PSB-12Y	12 Oz	Yellow	Pack	1/12
PSB-24C	24 Oz	Clear	Pack	1/6
PSB-24R	24 Oz	Red	Pack	1/6
PSB-24Y	24 Oz	Yellow	Pack	1/6

## DECORATIVE PICKS



PK-P4

## DECORATIVE PICKS

- ◆ Available in a variety of styles and colors
- ◆ Easily displayed with hang-card packaging

ITEM	DESCRIPTION	SIZE	PCS/BAG	UOM	CASE
PK-P4	Parasol	3-15/16"	144	Bag	100
PK-C2	Cellophane Frills	2-9/16"	1,000	Bag	10
PK-C4	Cellophane Frills	3-15/16"	1,000	Bag	10
PK-A35	Plastic Arrow	3-7/16"	500	Bag	20
PK-S3	Plastic Sword	2-3/4"	500	Bag	20



PK-C2



PK-C4



PK-A35



PK-S3

**STAINLESS STEEL ROTARY CHEESE GRATER**  
 ♦ 18/8 stainless steel rotary grater with one drum for grating fine cheeses

ITEM	DESCRIPTION	UOM	CASE
GRTS-1	8-1/4"L x 4-3/4"W x 3-3/8"H	Each	12/36

**PLASTIC ROTARY CHEESE GRATER**  
 ♦ Ideal for grating hard cheese or chocolate  
 ♦ Includes 2 interchangeable drums for fine and coarse grating  
 ♦ Dishwasher safe

ITEM	DESCRIPTION	UOM	CASE
PRTS-2	7"L x 3-1/2"W x 4"H	Each	6/24

**ZESTER GRATERS**  
 ♦ Etched 18/8 stainless steel blade  
 ♦ Comes with cover for the blade  
 ♦ Comfortable soft-grip handle  
 ♦ Superior anti-corrosion properties and durability

ITEM	DESCRIPTION	UOM	CASE
GT-103	Medium Coarse Blade	Each	12/72
GT-104	Zester Blade	Each	12/72
GT-105	Fine Blade	Each	12/72
GT-106	Ribbon Blade	Each	12/72

**CHEESE KNIFE SETS**

*Whether it's for a wine tasting event or to accompany dessert, present and serve a full range of cheeses elegantly with these 6-piece cheese knife sets.*

- ♦ Each set includes 6 knives for hard, soft, firm or crumbly cheeses
- ♦ Stainless steel blades

ITEM	DESCRIPTION	UOM	CASE
KCS-6	6-Pc Set w/POM Hdls	Set	1/48
KCS-6W	6-Pc Set w/Wooden Hdls	Set	1/48



**WOOD BREAD/CHEESE BOARDS**

ITEM	DESCRIPTION	UOM	CASE
WCB-125	12" x 5" x 3/4"	Each	24
WCB-225	22-1/2"L x 5-1/2"W x 3/4"H	Each	12

**TABLESIDE SERVICE**

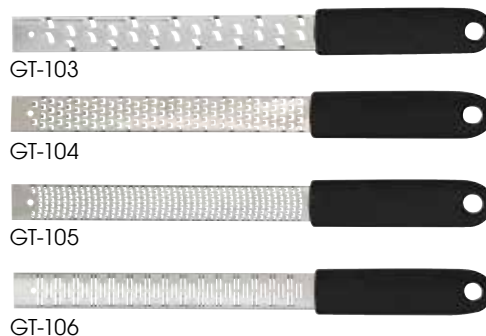

**NEW**

WCB-225 **AVAILABLE IN FEBRUARY 2018**

## SEAFOOD SERVICE



ASFT-12



SFR-4



## SEAFOOD TRAYS

Create an enticing tabletop spread with these trays in assorted sizes for displaying seafood or appetizers. The brushed aluminum construction retains cold and keeps foods at safe serving temperatures.

ITEM	DESCRIPTION	UOM	CASE
ASFT-12	12"Dia x 1-1/2"H	Each	12/36
ASFT-14	13-3/4"Dia x 1-1/2"H	Each	12/36
ASFT-16	15-3/4"Dia x 1-1/2"H	Each	12/24
ASFT-18	17-3/4"Dia x 1-1/2"H	Each	12/24
ASFT-20	19-3/4"Dia x 1-1/2"H	Each	12



### CHROME-PLATED SEAFOOD TRAY RACKS

- ◆ Use with ASFT-series seafood trays to create appealing tabletop presentations
- ◆ Also perfect for elevating serving plates, bowls and platters, as well as holding pizza pans

ITEM	DESCRIPTION	UOM	CASE
SFR-4	7-3/8" Top Dia / 9-5/8" Bottom Dia x 4-3/8"H	Each	1/20
SFR-7	7-3/8" Top Dia / 9-5/8" Bottom Dia x 7"H	Each	1/20

## LOBSTER CRACKERS

ITEM	DESCRIPTION	SIZE	UOM	CASE
LC-01	Stainless Steel	6"	Each	12/72
LC-03	Chrome Plated, Large	6"	Each	12/144
LC-04	Nut/Lobster Cracker	4-3/4"	Each	24/144
LC-05	Zinc Alloy	6"	Each	12/72
LC-85	Zinc Alloy, Carded	6"	Each	12/72



LC-85



LC-01



LC-03



LC-04



LC-05



LC-08



SBW-35



### SEAFOOD PICKS

- ◆ 18/8 stainless steel with decorative lobster stamp
- ◆ Narrow two-tine fork designed to effortlessly extract more shellfish meat

ITEM	DESCRIPTION	UOM	CASE
LC-08	8"L x 3/4"W, 4-Pcs/Pk	Pack	30/120

## BUTTER WARMER

- ◆ Set includes stand, butter cup, candle holder and candle

ITEM	DESCRIPTION	UOM	CASE
SBW-35	4-Pc Set	Set	1/48



SND-6



SND-T6



SND-F7

## SNAIL SERVICE

- ◆ Stainless steel

ITEM	DESCRIPTION	UOM	CASE
SND-6	Dish, 6-Holes	Each	12/144
SND-T6	Tongs	Each	12/120
SND-F7	Fork	Doz	1/50



### RESERVED SIGN

- ◆ Stainless steel

ITEM	DESCRIPTION	UOM	CASE
RVS-4	4-3/4" x 1-3/4", S/S	Each	12/120

### RESERVED SIGN



RVS-4

### TABLE CRUMBERS

- ◆ Aluminum
- ◆ Features a pocket clip

ITEM	DESCRIPTION	UOM	CASE
ATC-16G	6", Gold	Each	120/600
ATC-16S	6", Silver	Each	120/600

### TABLE CRUMBERS



ATC-16G



ATC-16S

### CALL BELLS

- ◆ Chrome plated with plastic base

ITEM	DESCRIPTION	UOM	CASE
CBEL-1	3-1/2"Dia	Each	12/144
CBEL-2	4"Dia	Each	12/72

### CALL BELLS



CBEL-1



CBEL-2

### ORDER RACKS

- ◆ Aluminum
- ◆ New style takes up less space to mount, easily fits onto narrow counter edges

ITEM	DESCRIPTION	UOM	CASE
ODR-18N	18"	Each	12/24
ODR-24N*	24"	Each	12/24
ODR-36N*	36"	Each	12/24
ODR-48N*	48"	Each	12/24

### ORDER RACKS



ODR-24N

### GUEST ORDER/CHECK HOLDERS

- ◆ Classic check holder has a grooved spine to hold a pen
- ◆ Folding-style prevents contents from falling out
- ◆ Slots for credit card and check

ITEM	DESCRIPTION	UOM	CASE
CHK-1K	10" x 5-1/2"	Each	12/96
CHK-2K	5-1/4" x 8-1/2" w/Elastic Pen Loop	Each	12/96

### CHECK SERVICE



CHK-2K



CHK-1K

### TIP TRAY

ITEM	DESCRIPTION	UOM	CASE
TT-46	4-1/2" x 6-1/2"	Doz	1/12



TT-46

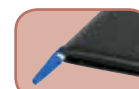

CHK-1K closes flat with pen inside

### CHECK SPINDLE

ITEM	DESCRIPTION	UOM	CASE
CS-1	6" H, Steel Wire	Each	12/240



CS-1

### CHECK CADDY

ITEM	DESCRIPTION	UOM	CASE
CS-3	3"Dia, Brass-Plated	Each	12/36



CS-3

### COUNTERFEIT DETECTION PEN

- ◆ Fast and easy way to detect fraudulent bills
- ◆ Great for the busy retail or restaurant environment
- ◆ Can be used with other counterfeit detection methods
- ◆ Each pack contains two (2) pieces

ITEM	DESCRIPTION	UOM	CASE
PPM-2	2-Pcs/Pk	Pack	18/72



PPM-2

## CONDIMENT PACKET HOLDER

AVAILABLE IN MARCH 2018

NEW



SCPH-33

SEE PAGE 186 FOR FOOD PANS

### STAINLESS STEEL CONDIMENT PACKET HOLDER

- ◆ Fits various configurations 1/3, 1/6 and 1/9-size steam table pans\*
- ◆ Ideal for keeping sugar, salt or sauce packets organized
- ◆ Two openings, each measures 12"L x 6-1/8"W
- ◆ Sloped angle allows easy access on crowded countertops

ITEM	DESCRIPTION	UOM	CASE
SCPH-33	16"L x 13-1/2"W x 9-1/4"H	Each	1



\*Pans sold separately

## MINI WASTE CAN



DDSF-101S



### STAINLESS STEEL MINI SWING-LID WASTE CAN

ITEM	DESCRIPTION	UOM	CASE
DDSF-101S	4-3/4"Dia x 6"H	Each	12/48

## TABLETOP DISPENSERS



BPA FREE

ACSD-712



BPA FREE

ACTD-3



NH-5



NH-7



SDP-3

### ACRYLIC STRAW DISPENSER

- ◆ BPA-free

ITEM	DESCRIPTION	UOM	CASE
ACSD-712	10-3/4" x 4-3/4" x 7"	Each	6



### ACRYLIC TOOTHPICK DISPENSER

- ◆ BPA-free

ITEM	DESCRIPTION	UOM	CASE
ACTD-3	3" x 2-1/2" x 4"	Each	6/36



### PLASTIC VERTICAL STRAW DISPENSER

- ◆ Break-resistant polycarbonate holder with stainless steel pull-up dispenser feature
- ◆ Capacity 100 straws

ITEM	DESCRIPTION	UOM	CASE
SDP-3	3-3/8"Dia x 10-3/4"H	Each	1/12



### NAPKIN DISPENSERS

- ◆ Stainless steel

ITEM	DESCRIPTION	UOM	CASE
NH-5	3-1/2"W x 5"H	Each	1/36
NH-7	3-1/2"W x 7"H	Each	1/36

### STAINLESS STEEL ASHTRAY

ITEM	DESCRIPTION	UOM	CASE
SAS-4	4"Dia, Stackable	Each	24/96

### ASHTRAYS



SAS-4



MAS-4K



MAS-4R



### ASHTRAYS

- ◆ Heat resistant up to 380°F (193°C)

ITEM	DESCRIPTION	COLOR	UOM	CASE
MAS-4K	4"Dia	Black	Doz	12
MAS-4R	4"Dia	Red	Doz	12



### RECHARGEABLE TEALIGHTS

- ◆ A complete charge provides 12 hours of simulated flickering light
- ◆ Each tealight has an on/off switch on the bottom
- ◆ Includes linkable base, adapter and NiMH battery

ITEM	DESCRIPTION	SIZE	UOM	CASE
CLR-6S	6-Pcs/Pk	5-7/8"L x 3-7/8"W x 3-13/16"H	Set	1/20
CLR-12S	12-Pcs/Pk	11-1/4"L x 3-7/8"W x 4-3/4"H	Set	1/12

### RECHARGEABLE TEALIGHTS



CL-L

CLR-12S

### REPLACEMENT TEALIGHT

- ◆ Uses 1 CR2032 battery (included)
- ◆ Lasts over 60 hours

ITEM	DESCRIPTION	UOM	CASE
CL-L	1-1/2"Dia x 1-1/2"H	Each	12/240



### STABLEIZER TABLE WEDGES/SHIMS

*sTABLEize the customer's most common complaint of wobbly tables with these economical and practical plastic wedges!*

- ◆ sTABLEize wobbly tables
- ◆ sTABLEize shelves
- ◆ Install commercial glass doors and much more!
- ◆ Each pack contains 75 pieces

ITEM	DESCRIPTION	UOM	CASE
TW-75B	Black, Flexible	Pack	1/48
TW-75W	Translucent, Hard	Pack	1/48

### TABLE WEDGES

**STABLEizer**  
Installation Shims



75 pcs per container



TW-75B

TW-SERIES

**BPA FREE**



TW-75W





## TABLE CLOTHS & CLIPS

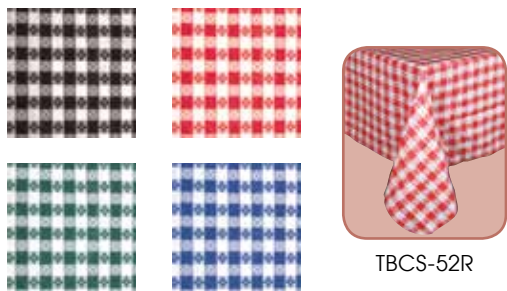

Available Colors  
TBCS & TBCO-SERIES

TBCS-52R



TBC-1

**FITS UP TO  
1-1/2" THICK  
TABLES**



Clip holds table cloth in place

## SERVICE & COAT CHECK



GLC-M



WA-3129K



WA-SERIES



WCH-1



CCK-5BL

CCK-5PK



CCK-5WT

CCK-5YL

## TABLE CLOTHS

◆ Plastic checkered pattern with cotton lining

ITEM	DESCRIPTION	COLOR	UOM	CASE
TBCS-52B	52" x 52" Square	Blue	Each	1/24
TBCS-52G	52" x 52" Square	Green	Each	1/24
TBCS-52R	52" x 52" Square	Red	Each	1/24
TBCS-52K	52" x 52" Square	Black	Each	1/24
TBCO-70B	52" x 70" Rectangle	Blue	Each	1/24
TBCO-70G	52" x 70" Rectangle	Green	Each	1/24
TBCO-70R	52" x 70" Rectangle	Red	Each	1/24
TBCO-70K	52" x 70" Rectangle	Black	Each	1/24
TBCO-90B	52" x 90" Rectangle	Blue	Each	1/24
TBCO-90G	52" x 90" Rectangle	Green	Each	1/24
TBCO-90R	52" x 90" Rectangle	Red	Each	1/24
TBCO-90K	52" x 90" Rectangle	Black	Each	1/24

## TABLE CLOTH CLIP

◆ Perfect for outdoor events

ITEM	DESCRIPTION	UOM	CASE
TBC-1	Stainless steel	Doz	6/60

## WHITE COTTON SERVICE GLOVES

ITEM	DESCRIPTION	COLOR	UOM	CASE
GLC-M	Medium (6 pairs)	White	Doz	100
GLC-L	Large (6 pairs)	White	Doz	100

## BISTRO-LENGTH APRON

◆ Cotton/poly blend, machine wash & dry, wrinkle resistant

ITEM	DESCRIPTION	COLOR	UOM	CASE
WA-3129K	31" x 29-1/2"	Black	Each	12/60

## 3-POCKET WAIST APRONS

◆ Cotton/poly blend, machine wash & dry, wrinkle resistant

ITEM	DESCRIPTION	COLOR	UOM	CASE
WA-1221	12-1/2" x 21-3/4"	Black	Each	12/60
WA-1221G	12-1/2" x 21-3/4"	Green	Each	12/60
WA-1221R	12-1/2" x 21-3/4"	Burgundy	Each	12/60
WA-1221W	12-1/2" x 21-3/4"	White	Each	12/60

## COAT HANGERS

ITEM	DESCRIPTION	UOM	CASE
WCH-1	Wooden	Doz	1/10

## COAT CHECK TICKETS

◆ Each box contains 500 pieces

ITEM	DESCRIPTION	UOM	CASE
CCK-5BL	Blue Tickets	Box	20
CCK-5PK	Pink Tickets	Box	20
CCK-5WT	White Tickets	Box	20
CCK-5YL	Yellow Tickets	Box	20

### DELIVERY BAGS

- ◆ Outer shell/liner: polyester; Filling: EPE
- ◆ Heat retention: 2 hours @ 167°F; 4 hours @ 131°F; 6 hours @ 95°F

ITEM	DESCRIPTION	UOM	CASE
BGDV-12	12" x 12" x 12"	Each	6
BGDV-22	22" x 22" x 12"	Each	6

### PIZZA BAGS

- ◆ Outer shell/liner: polyester; Filling: EPE
- ◆ Insulated lining keeps food warm for longer periods of time

ITEM	DESCRIPTION	UOM	CASE
BGPZ-18	18" x 18" x 5"	Each	6
BGPZ-20	20" x 20" x 5"	Each	6
BGPZ-24	24" x 24" x 5"	Each	6

### DELIVERY BAGS



### FLATWARE CYLINDERS & HOLDERS

- ◆ FC-PL/SS/SL fits 4" dia hole

ITEM	DESCRIPTION	UOM	CASE
FC-PL	Perforated, Plastic	Each	36/144
FC-SS	Perforated, S/S	Each	20/80
FC-SL	Solid, S/S	Each	20/80
FC-4H	4-Holes/2-Tier Holder, S/S	Each	1/4
FC-6H	6-Holes/2-Tier Holder, S/S	Each	1/2

### FLATWARE ORGANIZERS



### CUTLERY COMPARTMENT BINS

ITEM	DESCRIPTION	UOM	CASE
PL-4B	Plastic	Each	1/12
SCB-4	Stainless Steel	Each	1/8

### CUTLERY ORGANIZERS

ITEM	DESCRIPTION	UOM	CASE
OGZ-6	Organizer Bin Set	Set	1
OGZ-1B	Bin for OGZ-6	Each	6

### CUTLERY DISHWASHER BASKET

- ◆ Built-in handles
- ◆ NSF listed

ITEM	DESCRIPTION	SIZE	UOM	CASE
PCB-8	8 Compartments	17" x 8" x 6"	Each	12

### MULTI-SURFACE SWEEPER

- ◆ Non-electric rotary sweeper with natural bristles and steel handle

ITEM	DESCRIPTION	UOM	CASE
FSW-11	11"L x 7-3/4"W x 43"H	Each	1/4

### LOBBY PAN

- ◆ Built-in cover for mess-free transport

ITEM	DESCRIPTION	UOM	CASE
DP-13C	13"	Set	1/10

### ANGLED BROOM

- ◆ Made of plastic bristles

ITEM	DESCRIPTION	UOM	CASE
BRM-60L	60"	Each	12

### DINING ROOM MAINTENANCE



## HIGH CHAIRS & BOOSTERS



CHH-101A



CHH-103A



CHH-104A



CHH-601



CHH-25



CHB-701



CHB-703



CHB-704



CHB-2PK



CHB-2P

### STACKING HIGH-CHAIRS

- ◆ High-quality rubberwood
- ◆ Buckle strap restrains child around the waist
- ◆ Assembled size: 20-1/8"W x 19-3/8"D x 29-1/4"H, seat at 20"H

ITEM	DESCRIPTION	UOM	CASE
CHH-101	Natural, Knocked Down	Each	1
CHH-101A	Natural, Assembled	Each	1
CHH-103	Mahogany, Knocked Down	Each	1
CHH-103A	Mahogany, Assembled	Each	1
CHH-104	Walnut, Knocked Down	Each	1
CHH-104A	Walnut, Assembled	Each	1
CHH-2	High-Chair Strap, Black	Each	288
CHH-3	High-Chair Strap, 2-Pc Seat Belt, 1-Pc Center Strap	Set	12/240



CHH-3

### WOODEN PUB-HEIGHT HIGH CHAIR

- ◆ Assembled size: 19"W x 20"D x 41"H, seat at 32"H

ITEM	DESCRIPTION	UOM	CASE
CHH-601	Natural, Knocked Down	Each	1

### STACKABLE PLASTIC HIGH CHAIR

- ◆ Sturdy and durable polypropylene construction
- ◆ Plastic surface wipes clean after each use
- ◆ Snap-on tray included
- ◆ Assembly required
- ◆ Assembled size: 25-1/2"W x 23"D x 29-1/2"H
- ◆ Stackable with tray removed

ITEM	DESCRIPTION	UOM	CASE
CHH-25	High Chair w/Tray, Plastic	Set	1

### STACKING BOOSTER SEATS

- ◆ High-quality rubberwood
- ◆ Buckle strap restrains child around the waist
- ◆ Additional strap used for securing the booster to the chair
- ◆ Size: 11-3/4"W x 11-3/4"D x 10-1/2"H

ITEM	DESCRIPTION	UOM	CASE
CHB-701	Natural	Each	1
CHB-703	Mahogany	Each	1
CHB-704	Walnut	Each	1

### DOUBLE-SIDED BOOSTER SEATS

- ◆ Features include contoured seat, high sides, wide square base and non-skid surface
- ◆ Durable polyethylene will never dent, chip, rust or break
- ◆ Buckle strap restrains child around the waist with additional strap used for securing the booster to the chair
- ◆ Dishwasher safe
- ◆ Size: 12"W x 11-7/8"D x 9-1/4"H

ITEM	DESCRIPTION	UOM	CASE
CHB-2PK	Black	Each	1
CHB-2P	Brown	Each	1



### "OPEN" LED SIGNS

- ◆ UL listed adaptor

ITEM	DESCRIPTION	UOM	CASE
LED-6	Rectangle, 1 Flashing Pattern	Each	1/5
LED-10	Oval, 3 Flashing Patterns	Each	1/5

### LED SIGNS



LED-10



LED-6



LED-11

LED-SERIES 

### "PIZZA" LED SIGN

- ◆ Dust proof cover
- ◆ UL listed adaptor

ITEM	DESCRIPTION	UOM	CASE
LED-11	Oval, 3 Flashing Patterns	Each	1/5

### STANCHION SYSTEMS

- ◆ Heavy base stand with 36" post and 6-1/2' retractable belt
- ◆ Stanchions must be purchased in multiples of two (2)

ITEM	DESCRIPTION	UOM	CASE
CGS-38K	Black Stanchion	Each	2
CGS-38S	Stainless Steel Stanchion	Each	2
CGS-WB	Wall Bracket for CGS-38K/S	Each	100
CGS-K	Plstc Head w/Black Belt for CGS-38K/S	Each	12/48
CGSF-12K	Black Frame for CGS-38K	Each	1/4
CGSF-12S	Stainless Steel Frame for CGS-38S	Each	1/4

### STANCHION SIGN SYSTEMS



CGSF-12K



CGSF-12S



CGS-38K



CGS-38S



CGS-WB



CGS-K

### STANCHION FRAME SIGNS

ITEM	DESCRIPTION	UOM	CASE
SGN-801	Please Enter Here	Each	6/36
SGN-802	Please Wait To Be Seated	Each	6/36
SGN-803	Line Forms Here	Each	6/36
SGN-804	Sorry Section Closed	Each	6/36
SGN-805	Exit	Each	6/36



SGN-800 SERIES

### HOSTESS SIGN

- ◆ 60" tall sign stand with interchangeable messages
- ◆ Includes 15 message signs, a stand and base
- ◆ Easy to assemble

ITEM	DESCRIPTION	UOM	CASE
HTS-60K	Hostess Sign	Set	1/4

### HOSTESS SIGN

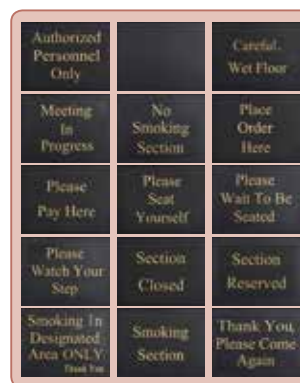

HTS-60K

# INFORMATION SIGNS

Our information/way-finding signs are available in 9" x 3" and 6" x 9" sizes with universal symbols and clear letters on anti-glare surfaces.



SGN-SERIES  
3" X 9"



## 9"W X 3"H INFORMATION SIGNS

ITEM	DESCRIPTION	COLOR	UOM	CASE
SGN-301	Push	Black	Each	12/144
SGN-302	Pull	Black	Each	12/144
SGN-303	Hand Wash Only	Black	Each	12/144
SGN-304	Private	Black	Each	12/144
SGN-305	Employees Only	Black	Each	12/144
SGN-310	No Smoking	Black	Each	12/144
SGN-311	Men	Black	Each	12/144
SGN-312	Women	Black	Each	12/144
SGN-313	Restrooms	Black	Each	12/144
SGN-317	Restroom for Customer Use Only	Black	Each	12/144
SGN-318	Wash	Black	Each	12/144
SGN-322	Employees Must Wash Hands Before Returning to Work	Black	Each	12/144
SGN-325	Telephone	Black	Each	12/144
SGN-326	Caution/Watch Your Step	Black	Each	12/144
SGN-327	Rinse	Black	Each	12/144
SGN-328	Reserved	Black	Each	12/144
SGN-329	Sanitize	Black	Each	12/144
SGN-330	WiFi	Black	Each	12/144
SGN-331	No Admittance	Black	Each	12/144
SGN-332	No Pets/Shoes/Shirt Required	Black	Each	12/144
SGN-333	No Food or Drink	Black	Each	12/144
SGN-334	No Cell Phone Use, Please	Black	Each	12/144
SGN-335	No E-Cigarettes	Black	Each	12/144
SGN-381W	Exit	White	Each	12/144
SGN-382W	Fire Extinguisher	White	Each	12/144



SGN-SERIES  
6" X 9"



## 6"W X 9"H INFORMATION SIGNS

ITEM	DESCRIPTION	COLOR	UOM	CASE
SGN-601	No Smoking	Black	Each	12/72
SGN-603	Restrooms	Black	Each	12/72
SGN-651B	Women	Blue	Each	12/72
SGN-652B	Men	Blue	Each	12/72
SGN-653B	Accessible	Blue	Each	12/72
SGN-681W	Exit	White	Each	12/72
SGN-682W	Fire Extinguisher	White	Each	12/72
SGN-683W	In Case of Fire Do Not Use Elevator... Use Stairs	White	Each	12/72
SGN-684W	No Smoking Area	White	Each	12/72

### BRAILLE



SGNB-SERIES  
6" X 9"



## 6"W X 9"H INFORMATION SIGNS WITH BRAILLE

ITEM	DESCRIPTION	COLOR	UOM	CASE
SGNB-601	No Smoking	Black	Each	12/72
SGNB-603	Restrooms	Black	Each	12/72
SGNB-604	Exit	Black	Each	12/72
SGNB-605	Men	Black	Each	12/72
SGNB-606	Women	Black	Each	12/72
SGNB-651B	Women/Accessible	Blue	Each	12/72
SGNB-652B	Men/Accessible	Blue	Each	12/72
SGNB-653B	Accessible	Blue	Each	12/72

## DISPLAY SIGNAGE BOARDS & ACCESSORIES

- ◆ Perfect for bakeries, cafes, coffee shops, pubs and restaurants
- ◆ Made for frequently changing specials, the High-tech Absol-Flat black glossy surface allows for clean and mess-free writing
- ◆ Solid 1-1/4" wide frame with double reinforced joints
- ◆ Durable packaging prevents damage while in transit



### WOODEN FRAME MARKER BOARDS

ITEM #	DESCRIPTION	INCLUDES	SIZE	UOM	CASE
MBB-1	Natural	1 Standard White Marker & Eraser	23-5/8"L x 3/4"W x 31-5/8"H	Set	6
MBB-3	Mahogany	1 Standard White Marker & Eraser	23-5/8"L x 3/4"W x 31-5/8"H	Set	1/6

### DUAL-SIDED SIDEWALK A-FRAME MARKER BOARDS

ITEM #	DESCRIPTION	INCLUDES	SIZE	UOM	CASE
MBAF-1	Natural	4 Standard Markers & Eraser	20-3/8"L x 2"W x 39"H	Set	1
MBAF-3	Mahogany	4 Standard Markers & Eraser	20-3/8"L x 2"W x 39"H	Set	1
MBAF-4	Mahogany	4 Standard, 2 Deluxe Plus Markers & Eraser	25-1/4"L x 2"W x 45"H	Set	1
MBAF-5	Premium White Oak	2 Standard, 4 Deluxe Plus Markers & Eraser	25-1/4"L x 2"W x 45"H	Set	1

### PREMIUM TRIPOD DISPLAY EASEL

- ◆ A stylish lift to the wood frame marker boards
- ◆ Solid, 1" thick wooden frame has two adjustable deluxe planes with pure copper knobs, comes with rubber feet
- ◆ Factory assembled ensures superior stability over knock-down easels

ITEM #	DESCRIPTION	SIZE	UOM	CASE
MBBE-1	Natural	23-1/4"L x 1"W x 61"H	Set	1
MBBE-3	Mahogany	23-1/4"L x 1"W x 61"H	Set	1



*With floral ink to deliver the most vivid color, the Deluxe Plus markers write on every kind of surface.*

### DELUXE NEON MARKERS & ERASER

ITEM #	DESCRIPTION	SIZE	COLOR	UOM	CASE
MBPM-B	Deluxe Plus	15g Ink, 1/16" Chisel	Neon Blue	Each	72/288
MBPM-G	Deluxe Plus	15g Ink, 1/16" Chisel	Neon Green	Each	72/288
MBPM-O	Deluxe Plus	15g Ink, 1/16" Chisel	Neon Orange	Each	72/288
MBPM-P	Deluxe Plus	15g Ink, 1/16" Chisel	Neon Pink	Each	72/288
MBPM-R	Deluxe Plus	15g Ink, 1/16" Chisel	Neon Red	Each	72/288
MBPM-U	Deluxe Plus	15g Ink, 1/16" Chisel	Neon Purple	Each	72/288
MBPM-W	Deluxe Plus	15g Ink, 1/16" Chisel	Neon White	Each	72/288
MBPM-Y	Deluxe Plus	15g Ink, 1/16" Chisel	Neon Yellow	Each	72/288
MBM-B	Standard	12g Ink, 1/4" Bullet	Neon Blue	Each	72/288
MBM-G	Standard	12g Ink, 1/4" Bullet	Neon Green	Each	72/288
MBM-P	Standard	12g Ink, 1/4" Bullet	Neon Pink	Each	72/288
MBM-R	Standard	12g Ink, 1/4" Bullet	Neon Red	Each	72/288
MBM-W	Standard	12g Ink, 1/4" Bullet	Neon White	Each	72/288
MBM-Y	Standard	12g Ink, 1/4" Bullet	Neon Yellow	Each	72/288
MB-E	Easy Wipe Eraser			Each	72/288





## VIRTUOSO COFFEE URNS

SEE PAGE 64  
FOR MATCHING  
VIRTUOSO  
CHAFERS



905A



903B

The modern design of the Virtuoso urns will add a stylish touch to any coffee and tea self-service station. The gleaming mirror-finish body is available in 3-gallon and 5-gallon capacities. A single fuel canister will keep contents warm and ready for dispensing.

- ◆ Made of extra-heavyweight stainless steel
- ◆ Available with gold accent legs or all stainless steel finish

### VIRTUOSO COFFEE URNS

ITEM	DESCRIPTION	UOM	CASE
905A	5 Gallon, Gold Legs	Set	1
905B	5 Gallon, S/S	Set	1
903A	3 Gallon, Gold Legs	Set	1
903B	3 Gallon, S/S	Set	1
FAUCET-CU	Stainless Steel Faucet	Each	1
FAUCET-JD	Plastic Faucet	Each	1



FAUCET-CU



FAUCET-JD

## JUICE DISPENSERS

The container of each dispenser holds up to 2.2 gallons and features an ice core in the center that keeps juices chilled without watering them down.

- ◆ Available with gold accents or in all stainless steel
- ◆ Mirror finish
- ◆ Removable container and drip tray for easy cleaning
- ◆ Break-resistant polycarbonate containers



901  
10-1/8"L x 13-3/4"W x 21-1/4"H



902  
10-1/8"L x 13-3/4"W x 21-1/4"H

### SINGLE JUICE DISPENSERS

ITEM	DESCRIPTION	UOM	CASE
901	Two-tone	Set	1
902	Stainless Steel	Set	1



901-FN

901-P1

### ACCESSORIES FOR JUICE DISPENSERS

ITEM	DESCRIPTION	UOM	CASE
901-FN	Faucet for 901, 902	Each	12/48
901-P1	PC Jar for 901, 902	Each	4

## PUNCH BOWL

### PUNCH BOWL

- ◆ Stainless steel mirror finish



SPB-35

ITEM	DESCRIPTION	UOM	CASE
SPB-35	3-1/2 Gal Punch Bowl with Decorative Ring Hds	Each	6

### ICED TEA DISPENSERS

*This tall and slender iced tea dispensers are the ideal solution for narrow countertops.*

- ◆ Made of stainless steel with a welded front handle
- ◆ Tall faucet with a detachable drip tray
- ◆ Includes 3 color decals: "Iced Tea", "Lemonade" and "Iced Coffee", as well as 1 blank decal for customization

ITEM	DESCRIPTION	SIZE	UOM	CASE
SSBD-3	3 Gal Dispenser	6-7/8"W x 13-3/4"D x 21"H	Set	1
SSBD-5	5 Gal Dispenser	6-7/8"W x 18-7/8"D x 21-1/4"H	Set	1



3 color and 1 blank decal included

### ICED TEA DISPENSERS



### PLASTIC BEVERAGE DISPENSERS

*An excellent option for limited counter spaces, the 3 gallon slim rectangular beverage dispenser has a graduated reservoir that detaches from an 8" high stand to pack up neatly for compact storage. For more spacious counters, a 3 gallon square dispenser is also available.*

- ◆ Leak-proof faucet
- ◆ Detachable drip tray and lid
- ◆ BPA-free

ITEM	DESCRIPTION	UOM	CASE
PBD-3	3 Gal Slim Rectangular Dispenser	Each	1
PBD-3SK	3 Gal Square Dispenser	Each	4
PBD-3-F	Faucet for PBD-3	Each	1
PBD-3SK-F	Faucet for PBD-3SK	Each	1/50

### PLASTIC BEVERAGE DISPENSERS



PBD-3SK

PBD-3 NSF

PBD-SERIES BPA FREE

### PLASTIC BEVERAGE DISPENSERS

*Perfect for mixing and serving a variety of beverages, this container dispenser comes with a snap-on lid and fitted with a handle for secure and easy transport.*

- ◆ Leak-proof faucet
- ◆ Bail handle with comfortable handgrip
- ◆ Red graduations in liters and quarts
- ◆ Temperature ranges from -40°F to 160°F
- ◆ Dishwasher safe
- ◆ BPA-free

ITEM	DESCRIPTION	UOM	CASE
PBDW-22	6 Gal, PP	Each	1/4
PBDW-FS	Faucet for PBDW-22	Each	1

### BEVERAGE CONTAINER DISPENSERS



PBDW-22

PBDW-SERIES BPA FREE

AIRPOTS

IMPROVED



APSK-725  
~Swivel base~

APSP-925  
~Swivel base~

AIRPOTS

Keep beverages hotter longer with these attractive stainless steel or glassed-lined airpots by Winco®. Double-wall insulation protects from damage and retains heat for an extended length of time. Ideal for concession stands, catered events, self-serve counters, offices and more.



STAINLESS STEEL LINED AIRPOTS

- ◆ Available with push button or lever top
- ◆ Heat retention: 10 hours at 175°F; 24 hours at 151°F
- ◆ Swivel base for easy access
- ◆ Double-wall insulated
- ◆ Stainless steel satin-finish body
- ◆ Includes four (4) "Lift & Twist" color tags for **Coffee, Decaf, Tea & Hot water**

ITEM	DESCRIPTION	UOM	CASE
APSK-725	2.5L Lever Top	Each	1/6
APSK-730	3L Lever Top	Each	1/6
APSP-925	2.5L Push Button	Each	1/6
APSP-930	3L Push Button	Each	1/6

COLORED IDENTIFICATION TAGS INCLUDED



"LIFT & TWIST" TAGS SUGGESTED FOR COFFEE, DECAF, TEA & HOT WATER

IMPROVED

NEW SIZE

AP-819



AP-525  
~Swivel base~

AP-825  
~Swivel base~



GLASS LINED AIRPOTS

- ◆ Available with push button or lever top
- ◆ Heat retention: 10 hours at 171°F; 24 hours at 147°F
- ◆ Swivel base for easy access
- ◆ Double-wall insulated
- ◆ Stainless steel satin-finish body
- ◆ Includes four (4) "Lift & Twist" color tags for **Coffee, Decaf, Tea & Hot water**

ITEM	DESCRIPTION	UOM	CASE
AP-522	2.2L Push Button	Each	1/6
AP-525	2.5L Push Button	Each	1/6
AP-535	3L Push Button	Each	1/6
AP-819	1.9L Lever Top	Each	1/6
AP-822	2.2L Lever Top	Each	1/6
AP-825	2.5L Lever Top	Each	1/6
AP-835	3L Lever Top	Each	1/6
AP-LTW	Lever-Top Lid	Each	50
AP-PTW	Push-Button Lid	Each	48



AP-LTW

AP-PTW



## WIRE AIRPOT RACKS

Ideal for countertop self-service. Economize space and keep service areas tidy with sturdy wire airpot racks. Available in both single and double-tiers.

- ◆ Ideal for self-service countertop beverage stations
- ◆ Features 4 sizes that accommodate different configurations
- ◆ Sturdy 1/4" thick heavy-duty wire construction resists bending or breaking
- ◆ Includes removable stainless steel drip tray(s) for easy cleanup
- ◆ Each rack features a sign holder to identify contents
- ◆ Fits Winco® APSK, APSP and AP-series airpots

ITEM	DESCRIPTION	UOM	CASE
APRK-2	Single Level, Holds 2 Airpots	Set	1/4
APRK-3	Single Level, Holds 3 Airpots	Set	1/4
APRK-4	Two Levels, Holds 4 Airpots	Set	1/2
APRK-6	Two Levels, Holds 6 Airpots	Set	1/2

## WIRE AIRPOT RACKS



Shown with 2 airpots on elevated legs attachment



APRK-3  
15"L X 12"D X 19"H (WITH SIGN)



APRK-2  
22"L X 12"D X 19"H (WITH SIGN)



APRK-6  
22"L X 25"D X 26-1/2"H (WITH SIGN)



APRK-4  
15"L X 25"D X 26-1/2"H (WITH SIGN)

## BEVERAGE DISPENSERS



SBD-1.5



### GRAVITY BEVERAGE DISPENSER WITH SIGHT GLASS

An ideal solution for busy self-service stations, this gravity beverage dispenser features a sight glass to view level of contents for refill needs and a brew-thru lid for brewing directly into the dispenser.

- ◆ Patented structure easily detaches body from stand
- ◆ Tomlinson® faucet with protection guard
- ◆ Double-wall vacuum insulated
- ◆ Retains heat for 4-6 hours
- ◆ Sturdy plastic handle for easy lifting and carrying
- ◆ Stainless steel satin-finish

ITEM	DESCRIPTION	UOM	CASE
SBD-1.5	1.5 Gal	Each	1/1

## STAINLESS STEEL BEVERAGE SIGNS



SGN-SERIES  
TENT SIGNS

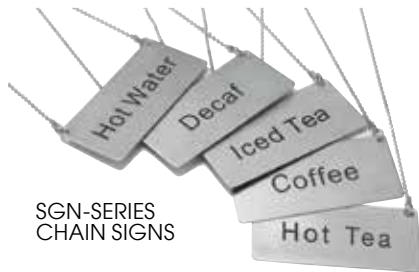

SGN-SERIES  
CHAIN SIGNS

With oversized black letters on stainless steel, these beverage tent and chain signs are must-haves for buffets and beverage stations.

### TENT SIGNS

- ◆ 3"L x 1-1/4"H x 1-1/2"D

ITEM	DESCRIPTION	UOM	CASE
SGN-100	Blank Sign	Each	12/120
SGN-101	Hot Tea	Each	12/120
SGN-102	Decaf	Each	12/120
SGN-103	Coffee	Each	12/120
SGN-104	Hot Water	Each	12/120
SGN-105	Iced Tea	Each	12/120

### CHAIN SIGNS

- ◆ 3-1/2"L x 1-3/4"W sign with 12" long chain

ITEM	DESCRIPTION	UOM	CASE
SGN-201	Hot Tea	Each	12/120
SGN-202	Decaf	Each	12/120
SGN-203	Coffee	Each	12/120
SGN-204	Hot Water	Each	12/120
SGN-205	Iced Tea	Each	12/120

## DRIP TRAYS



DT-45



DT-60



### DRIP TRAYS

- ◆ Dishwasher safe; removable grid.

ITEM	DESCRIPTION	UOM	CASE
DT-45	4-1/2" Tray, 4-Pcs/Pk	Pack	12/24
DT-60	6" Tray, 4-Pcs/Pk	Pack	12/24



DT-SERIES



**SWIRL DESIGN PUSH BUTTON BEVERAGE SERVERS**

- ◆ Double-wall insulated with durable plastic body
- ◆ Includes tags for regular, decaf and tea
- ◆ Available in black or white
- ◆ Hand wash only

ITEM	DESCRIPTION	UOM	CASE
VSW-20W	20 Oz, White	Each	1/24
VSW-42W	42 Oz, White	Each	1/12
VSW-64W	64 Oz, White	Each	1/6
VSW-20K	20 Oz, Black	Each	1/24
VSW-42K	42 Oz, Black	Each	1/12
VSW-64K	64 Oz, Black	Each	1/6

**INSULATED SERVERS**



VSW-64W

VSW-64K

VSW-SERIES NSF

**STAINLESS STEEL LINED COFFEE SERVER**

- ◆ Double-wall insulated; satin-finish

ITEM	DESCRIPTION	UOM	CASE
VSS-508	20 Oz	Each	12



VSS-508

ALL STAINLESS STEEL

**CARAFES**

- ◆ Stainless steel lined
- ◆ Heat retention: 6 hours at 171°F; 24 hours at 121°F
- ◆ Double-wall insulated
- ◆ Push button

ITEM	DESCRIPTION	UOM	CASE
CF-1.2	1.2L	Each	1/8
CF-1.5	1.5L	Each	1/8
CF-2.0	2L	Each	1/8
CF-LID	Lid for CF-1.2/1.5/2.0	Each	1



CF-1.5

CF-2.0

CF-1.2

**COFFEE/CREAM SERVERS**

- ◆ Double-wall stainless steel vacuum insulation keeps liquids hot or cold for a longer period of time
- ◆ Stainless steel lined interior provides extra durability and safety

ITEM	DESCRIPTION	UOM	CASE
VSS-24	24 Oz	Each	12
VSS-33	33 Oz	Each	12



VSS-24

VSS-33



## STAINLESS STEEL PITCHERS



WPB-2H



WPB-2CH



WPB-2



WPB-2C



BS-64



WPG-64



GS-10



JB2920



W632



## HAMMERED BELL PITCHERS

*Stylish and versatile, the hammered mirror-finish bell pitcher is great for serving cold beverages. Ice guard version also available!*

ITEM	DESCRIPTION	UOM	CASE
WPB-2H	2 Qt	Each	1/24
WPB-2CH	2 Qt w/Ice Guard	Each	1/24
WPB-3H	3 Qt	Each	1/24
WPB-3CH	3 Qt w/Ice Guard	Each	1/24

## DELUXE BELL PITCHERS

ITEM	DESCRIPTION	UOM	CASE
WPB-2	2 Qt	Each	1/24
WPB-2C	2 Qt w/Ice Guard	Each	1/24
WPB-3	3 Qt	Each	1/24
WPB-3C	3 Qt w/Ice Guard	Each	1/24

## CLASSIC COFFEE & WATER SERVERS

ITEM	DESCRIPTION	UOM	CASE
BS-64	64 Oz Coffee Server	Each	1/12
WPG-64	64 Oz Water Pitcher with Ice Guard	Each	1/12



## SERVER/CREAMER

ITEM	DESCRIPTION	UOM	CASE
GS-10	10 Oz, Gooseneck	Each	1/36



## GOOSENECK TEAPOT

ITEM	DESCRIPTION	UOM	CASE
JB2920	20 Oz	Each	1/24
JB2932	32 Oz	Each	1/24



## SHORT SPOUT BEVERAGE SERVERS

ITEM	DESCRIPTION	UOM	CASE
W612	12 Oz	Each	1/50
W632	32 Oz	Each	1/50
W670	70 Oz	Each	1/30

## TEAPOT & ACCESSORIES

AVAILABLE IN  
FEBRUARY 2018

NEW



GTP-25



GHT-10



GHT-10C



STB-7



## 25 OZ GLASS TEAPOT WITH INFUSER BASKET

*Serve freshly steeped tea in this attractive glass teapot with removable stainless steel infuser basket, the perfect complement to any tea service.*

- ◆ Fine stainless steel mesh strainer
- ◆ Glass carafe cradled in plastic body, suitable for loose tea brewing



ITEM	DESCRIPTION	UOM	CASE
GTP-25	25 Oz, 6"L x 4-3/4"W x 5-1/2"H	Each	48

## GLASS HOTTE

- ◆ Non-slip, heat resistant plastic grip; includes plastic lid
- ◆ Can also be used to steep tea
- ◆ Dishwasher safe

ITEM	DESCRIPTION	UOM	CASE
GHT-10	10 Oz	Each	12/24
GHT-10C	Replacement Lid for GHT-10	Each	12/600

## STAINLESS STEEL TEA INFUSER BALL

ITEM	DESCRIPTION	UOM	CASE
STB-5	2"	Each	40/240
STB-7	3"	Each	40/240

**WATER PITCHERS**

◆ BPA-free break-resistant SAN plastic

ITEM	DESCRIPTION	UOM	CASE
WPS-32	32 Oz, 4-Pcs/Pk	Pack	12
WPS-60	60 Oz, 4-Pcs/Pk	Pack	8



**WATER PITCHER WITH ICE TUBE**

ITEM	DESCRIPTION	UOM	CASE
WPIT-19	64 Oz, PC	Each	1/12

**THREE-SPOUT WATER PITCHERS**

ITEM	DESCRIPTION	UOM	CASE
WPCT-60A	60 Oz, Amber, PC	Each	12
WPCT-60C	60 Oz, Clear, PC	Each	12

**SINGLE SPOUT CLEAR WATER PITCHERS**

ITEM	DESCRIPTION	UOM	CASE
WPC-32	32 Oz, PC	Each	1/12
WPC-48	48 Oz, PC	Each	12
WPC-60	60 Oz, PC	Each	1/12

**BEER PITCHER**

ITEM	DESCRIPTION	UOM	CASE
WPCB-60	60 Oz, PC	Each	12

**DECANTERS WITH FLIP TOP LIDS**

◆ NSF listed

ITEM	DESCRIPTION	UOM	CASE
PDT-05	0.5 Qt, PC	Each	24
PDT-10	1 Qt, PC	Each	24
PDT-15	1.6 Qt, PC	Each	24

**PLASTIC PITCHERS**



WPS-32

BPA FREE

WPS-60

BPA FREE



WPIT-19

WPCT-60A

WPCT-60C



WPC-SERIES NSF

WPCB-60 NSF

PDT-SERIES NSF



**HAVANA TUMBLERS**

◆ BPA-free break-resistant SAN plastic

◆ Safe for commercial dishwasher

ITEM	DESCRIPTION	SIZE	UOM	CASE
PTSN-9	Blue	9 Oz	Doz	6
PTSN-12	Blue	12 Oz	Doz	6
PTSN-16	Blue	16 Oz	Doz	4



**PEBBLED TUMBLERS**

ITEM	DESCRIPTION	SIZE	UOM	CASE
PTP-05A	Amber	5 Oz	Doz	6
PTP-05B	Blue	5 Oz	Doz	6
PTP-05C	Clear	5 Oz	Doz	6
PTP-05R	Red	5 Oz	Doz	6
PTP-08A	Amber	8 Oz	Doz	6
PTP-08B	Blue	8 Oz	Doz	6
PTP-08C	Clear	8 Oz	Doz	6
PTP-08R	Red	8 Oz	Doz	6
PTP-09A	Amber	9-1/2 Oz	Doz	6
PTP-09B	Blue	9-1/2 Oz	Doz	6
PTP-09C	Clear	9-1/2 Oz	Doz	6
PTP-09R	Red	9-1/2 Oz	Doz	6
PTP-12A	Amber	12 Oz	Doz	6
PTP-12B	Blue	12 Oz	Doz	6
PTP-12C	Clear	12 Oz	Doz	6
PTP-12R	Red	12 Oz	Doz	6
PTP-16A	Amber	16 Oz	Doz	6
PTP-16B	Blue	16 Oz	Doz	6
PTP-16C	Clear	16 Oz	Doz	6
PTP-16R	Red	16 Oz	Doz	6
PTP-20A	Amber	20 Oz	Doz	2
PTP-20B	Blue	20 Oz	Doz	2
PTP-20C	Clear	20 Oz	Doz	2
PTP-20R	Red	20 Oz	Doz	2
PTP-24A	Amber	24 Oz	Doz	2
PTP-24B	Blue	24 Oz	Doz	2
PTP-24C	Clear	24 Oz	Doz	2
PTP-24R	Red	24 Oz	Doz	2
PTP-32A	Amber	32 Oz	Doz	2
PTP-32B	Blue	32 Oz	Doz	2
PTP-32C	Clear	32 Oz	Doz	2
PTP-32R	Red	32 Oz	Doz	2

**PLASTIC DRINKWARE**



PTSN-SERIES

NSF

BPA FREE



PTP-SERIES-COLORS



PTP-SERIES



**ELECTRIC COFFEE WARMERS**  **ELECTRIC COFFEE WARMERS**

Keep coffee fresh, hot and ready to serve at the optimal serving temperature. Coffee warmers are ideal for any self-service area.

- ◆ Low-profile for maximum product visibility and countertop space conservation
- ◆ Durable stainless steel construction with ceramic plates
- ◆ Separate on/off switches for simple and convenient operation
- ◆ 120V~60Hz, 100W per burner
- ◆ ETL Safety and Sanitation listed



ITEM	DESCRIPTION	UOM	CASE
ECW-1	Single Burner	Each	1/6
ECW-2	Double Burners	Each	1/6
ECW-2S	Step-Up Double Burner	Each	1



**COFFEE PRESS**

 **FRENCH PRESS**

- ◆ Stainless steel frame with polypropylene handle
- ◆ Can also be used with loose leaf teas
- ◆ Glass carafe holds approximately 4 cups



ITEM	DESCRIPTION	UOM	CASE
FPCM-33	33 Oz, 3-3/4"Dia	Each	1/12

**COFFEE ACCESSORIES**

 **COFFEE SCOOP**

- ◆ Measures 1 tablespoon, long handle
- ◆ Fingerprint-resistant satin finish, 18/8 stainless steel



ITEM	DESCRIPTION	UOM	CASE
CSP-6	6" L	Each	12/288

 **STAINLESS STEEL FROTHING PITCHERS**



ITEM	DESCRIPTION	UOM	CASE
WP-14	14 Oz	Each	1/48
WP-20	20 Oz	Each	1/48
WP-33	33 Oz	Each	1/36
WP-50	50 Oz	Each	1/24
WP-66	66 Oz	Each	1/24

**STAINLESS STEEL COFFEE SERVER**

ITEM	DESCRIPTION	UOM	CASE
CD-64	64 Oz w/Cover	Each	1/12

**COFFEE DECANTERS**

- ◆ Use with coffee machines ONLY (no stove or gas burners)
- ◆ Stainless steel base



ITEM	DESCRIPTION	UOM	CASE
CD-64K	64 Oz Regular	Each	1/24
CD-64O	64 Oz Decaf	Each	1/24

**COFFEE DREDGE KNOCK BOX**

- ◆ Made of 23 gauge stainless steel
- ◆ Fits any 1/6th size opening



ITEM	DESCRIPTION	UOM	CASE
SCD-5	7"L x 6"W x 5"H	Each	1/24

**COFFEE DECANTER BRUSH**

ITEM	DESCRIPTION	UOM	CASE
CDB-11	11"L x 1-1/4"W x 1-1/4"H	Each	12/96

**COFFEE EQUIPMENT BRUSH**

ITEM	DESCRIPTION	UOM	CASE
BR-25	25"	Each	12/96



### CUP DISPENSING RACKS

Keep self-service counters neat and tidy with this economical organizer for paper, plastic or foam cups.

- ◆ Dispenses one at a time
- ◆ Can be loaded from the front or back
- ◆ Suction feet secure organizer to a flat surface
- ◆ For cups from 8 oz to 44 oz w/rims between 3-1/8" and 4" diameter
- ◆ Available with three (3) or four (4) tiers

ITEM	DESCRIPTION	UOM	CASE
CDR-3	3-Tier	Each	1/2
CDR-4	4-Tier	Each	1/2

### CUP RACKS

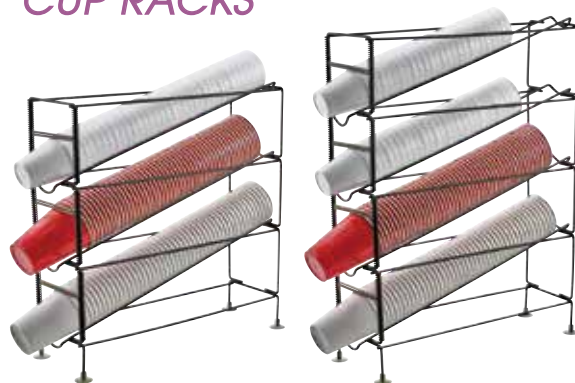

CDR-3  
20"L X 6-1/4"W X 19-1/4"H

CDR-4  
20"L X 6-1/4"W X 24-3/4"H



Simply twist springs to adjust for different cup sizes

### CUP & LID ORGANIZERS

The ideal solution for busy self-service stations with limited countertop space. These cup and lid organizers are made of durable ABS plastic that is easy to clean. Multi-functional compartments keep cups, lids, condiments and stirrers in their place.

ITEM	DESCRIPTION	UOM	CASE
CLO-2D	2 Tiers & 2 Stacks	Each	1/4
CLO-3D	2 Tiers & 3 Stacks	Each	1/4
CLSO-2T	3 Tiers & 2 Stacks	Each	1/4
CLSO-3T	3 Tiers & 3 Stacks	Each	1/4

### CUP ORGANIZERS



CLO-2D  
8-1/2"L x 8-5/8"W x 12-1/4"H



CLO-3D  
12-11/16"L x 8-5/8"W x 12-1/4"H



CLSO-2T  
8-1/2"L x 13-1/16"W x 12-3/16"H

CLSO-3T  
12-5/16"L x 12-3/4"W x 13-1/8"H

### IN-COUNTER CUP DISPENSER

Made for fast-food environments and busy self-service stations, this convenient and space-efficient in-counter cup dispenser utilizes a spring-loaded design to allow for one-at-a-time dispensing in horizontal, angled or vertical mounting positions.

- ◆ Made of durable ABS plastic
- ◆ Designed for cups with rim diameters from 3-1/8" to 4-1/2"
- ◆ Built-in clips allow dispenser to be adjusted without removing from the counter

ITEM	DESCRIPTION	UOM	CASE
CDIC-4	24"L x 5-1/4"Dia	Each	1/9

### CUP DISPENSER



CDIC-4



## DISPLAY TRAYS & RISERS



HRS-4



HPO-12

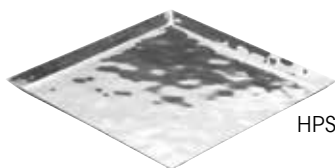

HPS-12



HPR-10

Made of 18/8 stainless steel, the surfaces of these trays and risers exhibit a glossy ripple effect in gleaming mirror finish, making them truly unique and elegant pieces for showcasing appetizers and desserts.

- ◆ Durable and stable surface for displaying
- ◆ Not recommended for prolonged use with acidic, creamy or salty ingredients
- ◆ Hand wash recommended

### NESTING RISER DISPLAY

- ◆ 4-piece nesting set

ITEM	DESCRIPTION	UOM	CASE
HRS-4	Riser 1: 5-1/2" x 5-1/2" x 5-1/2" Riser 2: 6-5/8" x 6-5/8" x 6-5/8" Riser 3: 7-7/8" x 7-7/8" x 7-7/8" Riser 4: 9" x 9" x 9"	Set	4

### DISPLAY TRAYS

- ◆ Available in a variety of shapes and sizes

ITEM	DESCRIPTION	UOM	CASE
HPO-12	Rectangular 12-5/8" x 7-1/4" x 1"	Each	12
HPO-14	Rectangular 13-3/4" x 7-3/4" x 1"	Each	12
HPO-15	Rectangular 15" x 8-1/2" x 1"	Each	12
HPS-10	Square 10-1/4" x 10-1/4" x 5/8"	Each	12
HPS-12	Square 11-3/4" x 11-3/4" x 5/8"	Each	12
HPS-13	Square 13-1/4" x 13-1/4" x 5/8"	Each	12
HPR-8	Round 8-7/8"Dia x 1-5/8"	Each	12
HPR-9	Round 9-5/8"Dia x 1-5/8"	Each	12
HPR-10	Round 10-1/4"Dia x 1-5/8"	Each	12

## DISPLAY BOWLS



TDS-3

TDSF-4

### TIERED GLASS BOWL DISPLAYS

These multi-tiered glass bowl servers provide a modern and attractive way to display cold salads, fruits and breads.

- ◆ 18/8 stainless steel mirror finish arms and bases
- ◆ Glass bowls are removable for easy cleaning, and microwave and dishwasher safe
- ◆ Available in 3-tier graduated set or 4-tier arm set
- ◆ Arms on the 4-tier set rotate 360°

ITEM	DESCRIPTION	UOM	CASE
TDS-3	3-Tier Set Base 9-3/4"Dia x 19-3/4"H	Set	1
TDSF-4	4-Tier Set Base 8-3/4"Dia x 20-1/2"H	Set	1
TDS-3-GLAS	Glass Bowl for TDS-3	Each	12
TDSF-4-GLS	Glass Bowl for TDSF-4	Each	12



DWAB-S

DWAB-L

### DOUBLE-WALL ANGLED DISPLAY BOWLS

A perfect mix of form and function, this stainless steel double-wall insulated bowl features indentations to allow for it to stand flat or at an angle.

- ◆ Maintains serving temperature for extended period of time without sweating or beading

ITEM	DESCRIPTION	UOM	CASE
DWAB-S	1-1/2 Qt	Each	1/12
DWAB-L	2-1/4 Qt	Each	1/6

## SEAFOOD TRAYS

Create an enticing tabletop spread with these trays in assorted sizes for displaying seafood or appetizers. The brushed aluminum construction retains cold and keeps foods at safe serving temperatures.

ITEM	DESCRIPTION	UOM	CASE
ASFT-12	12"Dia x 1-1/2"H	Each	12/36
ASFT-14	13-3/4"Dia x 1-1/2"H	Each	12/36
ASFT-16	15-3/4"Dia x 1-1/2"H	Each	12/24
ASFT-18	17-3/4"Dia x 1-1/2"H	Each	12/24
ASFT-20	19-3/4"Dia x 1-1/2"H	Each	12



### CHROME-PLATED SEAFOOD TRAY RACKS

- ◆ Use with ASFT-series seafood trays to create appealing tabletop presentations
- ◆ Also perfect for elevating serving plates, bowls and platters, as well as holding pizza pans

ITEM	DESCRIPTION	UOM	CASE
SFR-4	7-3/8" Top Dia / 9-5/8" Bottom Dia x 4-3/8"H	Each	1/20
SFR-7	7-3/8" Top Dia / 9-5/8" Bottom Dia x 7"H	Each	1/20

## SEAFOOD TRAYS



ASFT-12



SFR-4



## PEARL SHELL BOWLS

Made of light-weight ABS plastic, these shell bowls are ideal for displaying cold foods and salads.

ITEM	DESCRIPTION	UOM	CASE
PSBW-1W	20 Oz	Each	12/48
PSBW-5W	5 Qt	Each	6/12

### PEBBLED SALAD BOWLS

- ◆ Made of durable polycarbonate, these clear pebbled bowls are perfect for salads, fruits, desserts and snacks
- ◆ NSF listed

ITEM	DESCRIPTION	UOM	CASE
PBB-6	6"	Each	96
PBB-8	8"	Each	48
PBB-10	10"	Each	24
PBB-12	12"	Each	24
PBB-15	15"	Each	12
PBB-18	18"	Each	12

## BOWLS & CROCKS



PSBW-1W

PSBW-5W



PBB-10

PBB-SERIES



CRK-SERIES



CRK-SERIES



### DELI CROCKS & COVERS

Beautiful fluted finish combined with durable SAN plastic makes these crocks ideal for deli counter and picnic buffet presentations.

- ◆ BPA-free

ITEM	DESCRIPTION	COLOR	UOM	CASE
CRK-10R	10" x 7" x 3"	Red	Each	24
CRK-10K	10" x 7" x 3"	Black	Each	24
CRK-10C	10" x 7" x 3"	Clear	Each	24
CRK-10W	10" x 7" x 3"	White	Each	24
CRK-13R	13" x 10" x 3"	Red	Each	12
CRK-13K	13" x 10" x 3"	Black	Each	12
CRK-13C	13" x 10" x 3"	Clear	Each	12
CRK-13W	13" x 10" x 3"	White	Each	12
CRKC-10	Cover for CRK-10 Series	Clear	Each	48
CRKC-13	Cover for CRK-13 Series	Clear	Each	48



CRKC-13

CRKC-10



## ACRYLIC & PLASTIC DISPLAYS

NSF® CKS-13C



CKS-13



ADC-4



ADC-2



ADC-3



C-DP1

NSF® DOME COVERS



C-DPF1



C-DPF2



C-DPFH

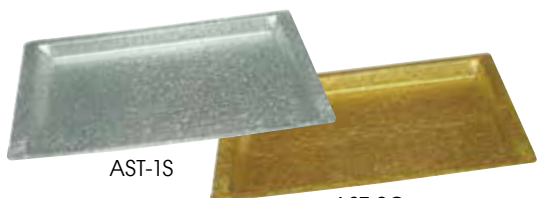

AST-1S

AST-2G



ACN-4

### CAKE STAND & COVER

- ◆ Assembly required for cake stand and cover
- ◆ Covers available for full case purchase only

ITEM	DESCRIPTION	UOM	CASE
CKS-13	13"Dia Stand, S/S	Each	6/12
CKS-13C	12"Dia Cover, Plastic	Each	6

### ACRYLIC DISPLAY CASES

ITEM	DESCRIPTION	SIZE	UOM	CASE
ADC-2	2-Tray, Front & Rear Doors	21" x 18" x 12"	Set	1
ADC-3	3-Tray, Rear Door	21" x 18" x 16-1/2"	Set	1
ADC-4	4-Tray, Front & Rear Doors	14" x 24" x 24"	Set	1
ADC-TY	Tray for All Display Cases		Each	12

### DOME COVERS

- ◆ Made of durable polycarbonate plastic
- ◆ Full-size dome can be used with AST-1S and AST-1G display trays
- ◆ C-DP1 & C-DPF1 fits full-size steam table pans and poly pans
- ◆ C-DP2 & C-DPF2 fits half-size steam table pans and poly pans
- ◆ NSF listed

ITEM	DESCRIPTION	SIZE	UOM	CASE
C-DP1	Full-size Cover	21-1/2" x 13-3/4"	Each	12
C-DP2	Half-size Cover	13-1/2" x 11"	Each	24
C-DPF1	Full-size Flip Cover	21-1/2" x 13-3/4"	Each	12
C-DPF2	Half-size Cut-out Cover	13-1/2" x 11"	Each	24

### HINGED DOME COVER

- ◆ Made of polycarbonate
- ◆ Fits full-size steam table pans and poly pans

ITEM	DESCRIPTION	SIZE	UOM	CASE
C-DPFH	Full-size Hinged Cover	21" x 13"	Each	12

### ACRYLIC TEXTURED DISPLAY TRAYS

Show off decadent pastries and sweets perfectly with the acrylic snake-skin textured display trays in silver or gold.

- ◆ Fits in all above display cases and under dome covers

ITEM	DESCRIPTION	SIZE	UOM	CASE
AST-1S	Silver Tray	20-3/4" x 12-3/4"	Each	24
AST-2G	Gold Tray, Acrylic	20-3/4" x 12-3/4"	Each	24

### ICE CREAM CONE HOLDER

ITEM	DESCRIPTION	SIZE	UOM	CASE
ACN-4	4-Hole Stand	12" x 4" x 4-1/2"	Each	1/12

### ROLL-TOP COVER

- ◆ 18/8 satin finish stainless steel
- ◆ Fits full-size 12" x 20" opening food pan
- ◆ Plastic handle is heat resistant up to 220°F (105°C)
- ◆ Can be used over standard sized food warmers/cookers

ITEM	DESCRIPTION	UOM	CASE
C-RCF	20-3/4"L x 13"W x 11-7/8"H	Each	1/2



C-RCF

### TRAYS & BASKETS

#### FIBERGLASS MARKET TRAYS

- ◆ Market trays are a must-have for displaying bakery and pastry items
- ◆ Edges reinforced with aluminum rods to prevent warping
- ◆ Molded-in lugs allow air circulation between stacked trays for quick drying
- ◆ NSF listed

ITEM	DESCRIPTION	COLOR	UOM	CASE
FGMT-0926B	9" x 26"	Brown	Each	12
FGMT-0926C	9" x 26"	Cream	Each	12
FGMT-0926K	9" x 26"	Black	Each	12
FGMT-0926W	9" x 26"	White	Each	12



FGMT-0926K  
26"L X 9"W

Available tray colors:



FGMT-SERIES

#### ANGLED DISPLAY ADAPTOR

Add some dimension to a buffet with an angled display adaptor to give steam table pans a lift to give guests a better view and easier access to food.

ITEM	DESCRIPTION	UOM	CASE
ADB-4	Full-size, S/S	Each	2/6

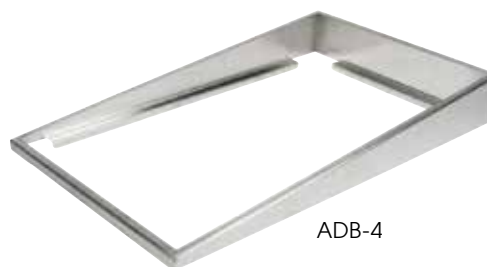

ADB-4

#### SOLID CORD POLY WOVEN BASKETS

- ◆ Flexible with reinforced weaving on rim and base for added durability
- ◆ Easily stackable
- ◆ Dishwasher safe

ITEM	DESCRIPTION	UOM	CASE
PWBK-1914T	Rectangular with Handles, Black, 3-Pcs/Pk	Pack	1/4
PWBN-1914T	Rectangular with Handles, Natural, 3-Pcs/Pk	Pack	1/4



PWBK-1914T  
19"L X 14"W X 4"H

#### NATURAL WOVEN BASKETS WITH HANDLES

ITEM	DESCRIPTION	UOM	CASE
PWBN-12B	12" x 8" x 3"	Each	12/96
PWBN-16B	16" x 11" x 3"	Each	12/48



PWBN-16B



## DISPLAY SIGNAGE BOARDS & ACCESSORIES

- ◆ Perfect for bakeries, cafes, coffee shops, pubs and restaurants
- ◆ Made for frequently changing specials, the High-tech Absol-Flat black glossy surface allows for clean and mess-free writing
- ◆ Solid 1-1/4" wide frame with double reinforced joints
- ◆ Durable packaging prevents damage while in transit



MBB-3 AND MBBE-3 GROUP



MBBE-1

### WOODEN FRAME MARKER BOARDS

ITEM #	DESCRIPTION	INCLUDES	SIZE	UOM	CASE
MBB-1	Natural	1 Standard White Marker & Eraser	23-5/8"L x 3/4"W x 31-5/8"H	Set	6
MBB-3	Mahogany	1 Standard White Marker & Eraser	23-5/8"L x 3/4"W x 31-5/8"H	Set	1/6

### DUAL-SIDED SIDEWALK A-FRAME MARKER BOARDS

ITEM #	DESCRIPTION	INCLUDES	SIZE	UOM	CASE
MBAF-1	Natural	4 Standard Markers & Eraser	20-3/8"L x 2"W x 39"H	Set	1
MBAF-3	Mahogany	4 Standard Markers & Eraser	20-3/8"L x 2"W x 39"H	Set	1
MBAF-4	Mahogany	4 Standard, 2 Deluxe Plus Markers & Eraser	25-1/4"L x 2"W x 45"H	Set	1
MBAF-5	Premium White Oak	2 Standard, 4 Deluxe Plus Markers & Eraser	25-1/4"L x 2"W x 45"H	Set	1

### PREMIUM TRIPOD DISPLAY EASEL

- ◆ A stylish lift to the wood frame marker boards
- ◆ Solid, 1" thick wooden frame has two adjustable deluxe planes with pure copper knobs, comes with rubber feet
- ◆ Factory assembled ensures superior stability over knock-down easels

ITEM #	DESCRIPTION	SIZE	UOM	CASE
MBBE-1	Natural	23-1/4"L x 1"W x 61"H	Set	1
MBBE-3	Mahogany	23-1/4"L x 1"W x 61"H	Set	1

## DELUXE NEON MARKERS & ERASER

With floral ink to deliver the most vivid color, the Deluxe Plus markers write on every kind of surface.



Deluxe Plus Broad Chisel Tip Markers



Standard Bullet Tip Markers



MB-E

ITEM #	DESCRIPTION	SIZE	COLOR	UOM	CASE
MBPM-B	Deluxe Plus	15g Ink, 1/16" Chisel	Neon Blue	Each	72/288
MBPM-G	Deluxe Plus	15g Ink, 1/16" Chisel	Neon Green	Each	72/288
MBPM-O	Deluxe Plus	15g Ink, 1/16" Chisel	Neon Orange	Each	72/288
MBPM-P	Deluxe Plus	15g Ink, 1/16" Chisel	Neon Pink	Each	72/288
MBPM-R	Deluxe Plus	15g Ink, 1/16" Chisel	Neon Red	Each	72/288
MBPM-U	Deluxe Plus	15g Ink, 1/16" Chisel	Neon Purple	Each	72/288
MBPM-W	Deluxe Plus	15g Ink, 1/16" Chisel	Neon White	Each	72/288
MBPM-Y	Deluxe Plus	15g Ink, 1/16" Chisel	Neon Yellow	Each	72/288
MBM-B	Standard	12g Ink, 1/4" Bullet	Neon Blue	Each	72/288
MBM-G	Standard	12g Ink, 1/4" Bullet	Neon Green	Each	72/288
MBM-P	Standard	12g Ink, 1/4" Bullet	Neon Pink	Each	72/288
MBM-R	Standard	12g Ink, 1/4" Bullet	Neon Red	Each	72/288
MBM-W	Standard	12g Ink, 1/4" Bullet	Neon White	Each	72/288
MBM-Y	Standard	12g Ink, 1/4" Bullet	Neon Yellow	Each	72/288
MB-E	Easy Wipe Eraser			Each	72/288



DELUXE PLUS SERIES

STANDARD SERIES

### STAINLESS STEEL CONDIMENT HOLDERS

ITEM	DESCRIPTION	UOM	CASE
CDP-4	4 Compartments	Each	1/16
CDP-5	5 Compartments	Each	1/16
CDP-6	6 Compartments	Each	1/16
CDP-1P	1pt Insert for CDP-4/5/6	Each	120
CDP-1Q	1qt Insert for CDP-4/5/6	Each	60

*There is no space for ice under the compartments.*

### PLASTIC BASE CONDIMENT HOLDERS

- ◆ Durable ABS holder with lid & removable food-grade poly inserts
- ◆ Perfect for storing garnish
- ◆ Dishwasher safe

ITEM	DESCRIPTION	SIZE	UOM	CASE
CCH-4	4 Compartments, Black, NSF	19-3/8" x 6-1/4" x 3-3/4"	Each	1/6
CCH-6	6 Compartments, Black, NSF	19-7/16" x 6-1/4" x 3-1/2"	Each	1/6
CCH-4IS	Inserts for CCH-4, 4-Pcs/Pk		Pack	24
CCH-6IS	Inserts for CCH-6, 6-Pcs/Pk		Pack	24
BC-4P	4 Compartments, White	18" x 5" x 3"	Set	6/36

*There is no space for ice under the compartments.*

### BAR CADDY

- ◆ BPA-free
- ◆ NSF listed

ITEM	DESCRIPTION	UOM	CASE
BC-6	6 Compartments, Plastic	Each	12

### CONDIMENT CADDIES



### DECORATIVE PICKS

- ◆ Available in a variety of colors
- ◆ Hanging card packaging for easy display

ITEM	DESCRIPTION	SIZE	PCS/PK	UOM	CASE
PK-P4	Parasol	3-15/16"	144	Bag	100
PK-S3	Plastic Sword	2-3/4"	500	Bag	20

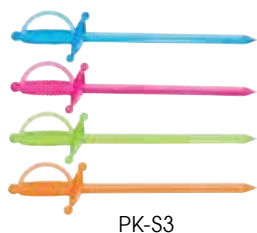

### DECORATIVE PICKS

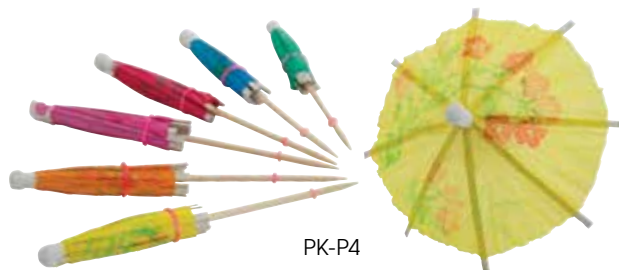

### ACRYLIC STRAW DISPENSER

- ◆ BPA-free

ITEM	DESCRIPTION	UOM	CASE
ACSD-712	10-3/4" x 4-3/4" x 7"	Each	6

### PLASTIC VERTICAL STRAW DISPENSER

- ◆ Break-resistant polycarbonate holder with stainless steel pull-up dispenser feature
- ◆ Capacity 100 straws

ITEM	DESCRIPTION	UOM	CASE
SDP-3	3-3/8"Dia x 10-3/4"H	Each	1/12

### STRAW DISPENSERS



## MOSCOW MULE MUGS



CMM-20

CMM-20H

**LEAD-FREE  
BRASS  
HANDLES**



CMM-2



CMM-2H



## COPPER-PLATED MOSCOW MULE MUGS

Whether serving its classic namesake drink or any refreshing cocktail, these rustic copper-plated mugs will instantly keep drinks extra cold, making them great additions to an outdoor bar setting.

ITEM	DESCRIPTION	UOM	CASE
CMM-20	20 Oz, Smooth Exterior	Each	36
CMM-20H	20 Oz, Hammered Exterior	Each	36



## MINI MOSCOW MULE MUGS

The popular Moscow Mule Mugs are now available in mini versions!

- ◆ 2 oz capacity
- ◆ Great for sauces
- ◆ 4-Pcs/Set

ITEM	DESCRIPTION	UOM	CASE
CMM-2	2 Oz, Smooth	Set	6/24
CMM-2H	2 Oz, Hammered	Set	6/24

## MINT JULEP CUPS



DDSE-101S



## STAINLESS STEEL MINT JULEP CUPS

ITEM	DESCRIPTION	UOM	CASE
DDSE-101S	3"Dia x 4-3/8"H	Each	12/72
DDSE-102S	3-3/8"Dia x 4-3/4"H	Each	12/72

## MIXING GLASS



WG10-001

## MIXING GLASS

- ◆ 24-Pcs/Case

ITEM	DESCRIPTION	UOM	CASE
WG10-001	16 Oz	Case	1

## SHAKERS



BS-310

BS-1P

BS-3B

BS-28P

BS-3P

BS-3P



## BAR SHAKER SETS

- ◆ Stainless steel
- ◆ 3-pc set includes cap, strainer and cup

ITEM	DESCRIPTION	UOM	CASE
BS-310	10 Oz Classic 3-Pc Set	Each	12/48
BS-1P	16 Oz Slender 3-Pc Set	Each	1/24
BL-28P	28 Oz Classic Deluxe 3-Pc Set	Each	1/12
BL-3P	16 Oz Classic 3-Pc Set	Each	24
BS-3B	24 Oz Beehive 3-Pc Set	Each	1/24
BS-3P	28 Oz Slender 3-Pc Set	Each	12



## CLEAR BAR SHAKER

ITEM	DESCRIPTION	UOM	CASE
BS-16PC	16 Oz Clear Bar Shaker	Each	1/24



BS-16PC

BS-15

BS-30

MCP-30

BS-28P

## BAR SHAKER CUPS

- ◆ Stainless steel

ITEM	DESCRIPTION	UOM	CASE
BS-15	15 Oz Shaker Cup	Each	12/144
BS-30	30 Oz Shaker Cup	Each	12/72
MCP-30	30 Oz Malt Cup	Each	12/72
BS-28P	28 Oz PVC Exterior	Each	24/48

**JAPANESE-STYLE JIGGERS**

- ◆ Stainless steel
- ◆ Rolled rim for easy pour and a high-end look

ITEM	DESCRIPTION	UOM	CASE
J-6	1/2 Oz x 3/4 Oz	Each	12/300
J-7	1/2 Oz x 1 Oz	Each	12/300
J-8	1 Oz x 1-1/4 Oz	Each	12/300
J-9	1 Oz x 2 Oz	Each	12/300

**STANDARD JIGGERS**

- ◆ Stainless steel
- ◆ Flip sides for different capacity measures

ITEM	DESCRIPTION	UOM	CASE
J-1	1/2 Oz x 1 Oz	Each	12/300
J-2	3/4 Oz x 1-1/4 Oz	Each	12/300
J-3	3/4 Oz x 1-1/2 Oz	Each	12/300
J-4	1 Oz x 1-1/2 Oz	Each	12/300
J-5	1 Oz x 2 Oz	Each	12/300

**DRINK PREP TOOLS**



J-9



J-1



J-3

**BAR ACCESSORIES**

- ◆ Stainless steel

ITEM	DESCRIPTION	UOM	CASE
BPS-11	11" Bar Spoon	Each	24/600
BST-4P	Hawthorne Strainer	Each	12/288
JST-1	Julep Strainer	Each	12/240

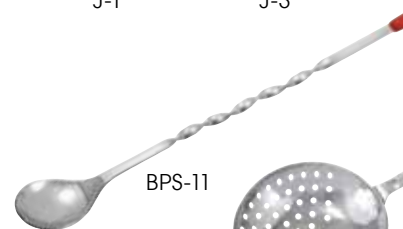

BPS-11



BST-4P



JST-1



MS2K-3S



**STRAINER-SIFTER**

Add an extra twist of citrus right into a cocktail with this 3" strainer. The fine mesh is great for catching pulp and small seeds.

- ◆ Stainless steel

ITEM	DESCRIPTION	UOM	CASE
MS2K-3S	3"Dia x 8"L x 1"H	Each	24/144



**BEER LAYERING SPOON**

A must-have for making black & tans or half & halves, the specially designed ridge of this spoon rests over the lip of the glass to allow for that essential slow pour, creating flawlessly layered beers.

ITEM	DESCRIPTION	UOM	CASE
BLS-6	1-5/8" Dia, S/S	Each	12/48



Beer layering



BLS-6



**GLASS RIMMERS**

ITEM	DESCRIPTION	UOM	CASE
GR-2	2-Tier, Plastic w/Sponge	Each	1/12
GR-3	3-Tier, Plastic w/Sponge, NSF	Each	1/12
GR-3S	Replacement Sponge, No Retail Packaging	Each	12/144



GR-3S



GR-2



GR-3





## MUDDLERS & SQUEEZERS



JC-16



JC-19



### TABLETOP JUICE SQUEEZERS

ITEM	DESCRIPTION	UOM	CASE
JC-16	Heavy-duty, 15"	Each	1/6
JC-19	Premium, 19"	Each	1/2



SBM-8N



WMW-8



PBM-8N



PBM-8T



MPS-42W

### MUDDLERS

◆ 8" long



ITEM	DESCRIPTION	UOM	CASE
SBM-8N	Netted Head, S/S	Each	12/96
WMW-8	Flat Head, Wooden	Each	24/144
PBM-8N	Netted Head, PC	Each	12/216
PBM-8T	Triangular Head, PC	Each	12/216



### MARBLE MORTAR & PESTLE SET

ITEM	DESCRIPTION	UOM	CASE
MPS-42W	4-1/2"Dia Bowl	Set	1/12



### STAINLESS STEEL MANUAL JUICE SQUEEZER

ITEM	DESCRIPTION	UOM	CASE
JC-4	5"Dia	Each	24



JC-4



LS-3

### STAINLESS STEEL LEMON/LIME SQUEEZER

ITEM	DESCRIPTION	UOM	CASE
LS-3	6"Dia	Each	12/144



### HANDHELD CITRUS SQUEEZERS

*Extract all the juice without the rind, pulp or seeds.*

- ◆ Aluminum with baked-on enamel coating
- ◆ Place citrus half with the cut side down in juicer and extract
- ◆ Dishwasher safe, long lasting, won't absorb odors, and resistant to moisture, heat and stains

ITEM	DESCRIPTION	UOM	CASE
LS-8G	2-1/2"Dia, 8"L	Each	6/48
LS-9O	3-1/2"Dia, 9-1/8"L	Each	9/36
LS-9Y	3"Dia, 8-3/4"L	Each	6/48



LS-8G



LS-9O



LS-9Y

## CUTTING BOARD



### GARNISH CUTTING BOARD

◆ NSF listed

ITEM	DESCRIPTION	UOM	CASE
CBWT-610	6" x 10" x 1/2"	Each	20

NSF CBWT-610

New Item

**WING-STYLE CORKSCREWS**

ITEM	DESCRIPTION	UOM	CASE
CO-501	Wing Type, Chrome	Each	12/144
CO-701	Wing Type, Black	Each	12/72

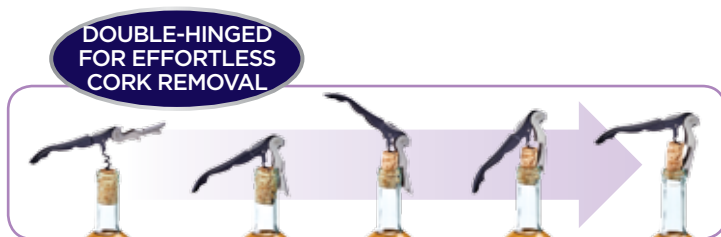

CO-720 double-hinged corkscrew in use

**BOTTLE OPENERS & CORKSCREWS**



**CORKSCREWS**

ITEM	DESCRIPTION	UOM	CASE
CO-720	Double Hinged Corkscrew	Each	6/96
CO-511	Waiter's Corkscrew, S/S, Made in Italy, No Retail Pkg.	Each	12/144
CO-512	Waiter's Corkscrew, Black, Made in Italy, No Retail Pkg.	Each	12/144
CO-711	Waiter's Corkscrew, S/S, Economy	Each	12/144
CO-712	Waiter's Corkscrew, Black, Economy	Each	12/144
CO-4DK	Black, 2-Pcs/Pk	Pack	24/96
CO-4DW	White, 2-Pcs/Pk	Pack	24/96



**FLAT BOTTLE OPENERS**

◆ Stainless steel

ITEM	DESCRIPTION	UOM	CASE
CO-301	Without Coating	Each	12/144
CO-301PB	Blue PVC Coating	Each	12/144
CO-301PK	Black PVC Coating	Each	12/144
CO-301PR	Red PVC Coating	Each	12/144



**CAN TAPPER/BOTTLE OPENER**

ITEM	DESCRIPTION	UOM	CASE
CO-201	Nickel Plated, 4"	Each	100/600
CO-302	Stainless Steel, 7"	Each	12/144
CO-303	Wooden Hdl, S/S, 7"	Each	12/144



**CAN OPENER**

◆ Made in Italy

ITEM	DESCRIPTION	UOM	CASE
CO-530	White Handles	Each	12/72



**UNDER-COUNTER STAINLESS STEEL BOTTLE OPENER**

ITEM	DESCRIPTION	UOM	CASE
CO-401	4-1/4"	Each	24/288

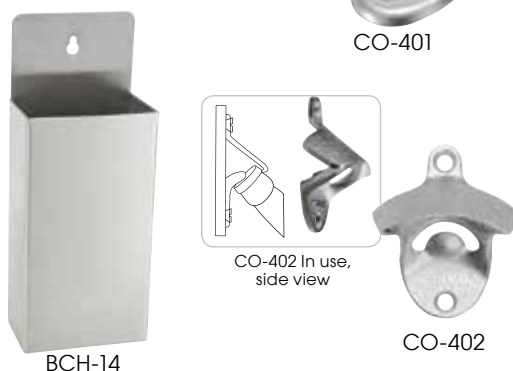

**WALL-MOUNT BOTTLE OPENER**

- ◆ Made of sturdy die-cast zinc alloy
- ◆ Wall-mounted for easy accessibility

ITEM	DESCRIPTION	UOM	CASE
CO-402	3-1/4"L x 2-3/4"W	Each	24/144



**BOTTLE CAP CATCH**

ITEM	DESCRIPTION	UOM	CASE
BCH-14	5-1/2"L x 3-1/2"W x 13-3/4"H	Each	1/24

ACCELMIX™ BLENDERS

**ACCELMIX™**  
by Winco®

ADD POWER & PERFORMANCE TO YOUR BAR



ETL Intertek ETL Intertek XLB-1000

BPA FREE TRITAN™ CONTAINER

NEW



ETL Intertek ETL Intertek XLB-44

BPA FREE TRITAN™ CONTAINER

ACCELMIX™ ELECTRIC COUNTERTOP BLENDERS

These commercial-grade blenders feature high-performance motors with impact-resistant stainless steel blades, adding power and performance to your busy establishment.

- ◆ Removable container covers and caps for adding/ blending ingredients mid-cycle
- ◆ All parts (except bases) are dishwasher safe
- ◆ ETL listed for electrical safety in US and Canada, conforms to UL-197 and CSA C22.2
- ◆ One year parts and labor warranty

EXTRA LARGE 68 OZ CAPACITY BLENDER

- ◆ 68 oz, break-resistant and BPA-free Tritan™ container
- ◆ High-performance 2 hp motor; unique high-impact blades
- ◆ Container/pitcher is heat-resistant up to 226°F (108°C); reduce pressure by removing cap in the lid
- ◆ 11-1/2" tamper included - fits through lid opening and reaches full length of container to blend/stir while mixing
- ◆ Metal-to-metal coupling; easy to operate "PULSE" and "ON/OFF" paddle controls, & variable speed control dial
- ◆ 120V~60Hz, 1450W, 12.1A
- ◆ Overall dimensions: 10"L x 9"W x 20"H
- ◆ Container: 6-1/4"L x 6-5/8"W x 11-1/2"H

ITEM	DESCRIPTION	UOM	CASE
XLB-1000	Accelmix 68 Oz Blender	Set	1/4
XLB1000P1	Rod Set	Each	1
XLB1000P2	Pitcher Assembly	Each	1
XLB1000P4	Refilling Cap	Each	1
XLB1000P5	Blade Assembly	Each	1
XLB1000P10	Mushroom Head Fitting	Each	1
XLB1000P11	68 oz Pitcher	Each	1



Cap removed, stirring tamper inserted



Blend fruits, ice and a variety of other ingredients

44 OZ BAR BLENDER

- ◆ 44 oz, break-resistant and BPA-free Tritan™ container
- ◆ Quiet, high-performance 1/2 hp self-lubricating motor; uniquely designed high-impact blades
- ◆ HIGH/LOW toggle switch for precise consistency control
- ◆ Blade is removable for easy cleaning
- ◆ Non-skid feet securely grip the surface for stable operation
- ◆ 120V~60Hz, 400W, 3.5A
- ◆ Overall: 7"L x 5"W x 15-1/4"H; container: 7"L x 5"W x 9"H

ITEM	DESCRIPTION	UOM	CASE
XLB-44	Accelmix 44 Oz Blender	Set	1/4
XLB44-P1	Filler Cap	Each	1
XLB44-P2	Container Lid	Each	1
XLB44-P3	44 oz Pitcher	Each	1
XLB44-P4	Gasket	Each	1
XLB44-P5	Blade Assembly	Each	1
XLB44-P6	Collar	Each	1
XLB44-P7	Clutch	Each	1

**ICE CUBE TRAYS**

These silicone trays make large 2" cubes of ice and keep drinks chilled longer than the typical ice cube.

- ◆ Silicone material for easy removal
- ◆ Cubes also fit any standard Whiskey glass

ITEM	DESCRIPTION	UOM	CASE
ICCT-4R	4-Cube Tray	Each	12/72
ICCT-8R	8-Cube Tray	Each	12/72

**ICE CUBE TRAYS**



ICCT-4R



ICCT-8R

**ROUND ICE CUBE TRAY**

Extend the chill with large round ice spheres that are proven to melt slower than standard-size ice cubes.

- ◆ Made of sturdy, stackable polypropylene
- ◆ Makes six (6) perfectly spherical 2" cubes
- ◆ 2-piece top and bottom tray for easy filling; stackable
- ◆ BPA-free

ITEM	DESCRIPTION	UOM	CASE
ICCP-6W	6-Cube Tray	Each	12/72



ICCP-6W



2-piece tray

**ICE PICK**

- ◆ Nickered Steel

ITEM	DESCRIPTION	UOM	CASE
ICH-1	9"L	Each	24/144



ICH-1

**ICE CHIPPER**

- ◆ 6-prong nickelered steel with wooden handle

ITEM	DESCRIPTION	UOM	CASE
ICH-9	9"L	Each	12/120



ICH-9

**ICE TONGS**

- ◆ Stainless Steel

ITEM	DESCRIPTION	UOM	CASE
ICT-7	Five Prong, Textured, 7"L	Each	12/144
IT-7	Three Prong, Satin Finish, 7"L	Each	12/120



ICT-7 Texture



ICT-7



IT-7

**ICE TOOLS**



## ICE CRUSHER



ICP-9



## MANUAL ICE CRUSHER

Easily make coarse or fine ice chips for cool drinks, as well as ice beds for shellfish.

ITEM	DESCRIPTION	UOM	CASE
ICP-9	6" x 4-7/8" x 9-1/2"H	Each	1/12

## ICE ONLY CONTAINERS



FCW-10ICE



FCW-10L

## "ICE ONLY" STORAGE CONTAINERS

◆ NSF listed

ITEM	DESCRIPTION	UOM	CASE
FCW-10ICE	10 Gal "Ice Only" Container	Each	1/6
FCW-20ICE	20 Gal "Ice Only" Container	Each	1/6
FCW-10L	Lid for FCW-10ICE	Each	1/24
FCW-20L	Lid for FCW-20ICE	Each	1/12



FCW-SERIES

## INSULATED ICE CADDY



IIC-29

## INSULATED ICE CADDY

- ◆ Can be used inside or outdoors, in hot or humid conditions
- ◆ Drain shelf keeps ice separate from the water, greatly increasing storage time
- ◆ Polyethylene molded body is durable and light-weight, top lid slides open
- ◆ Polyurethane foam insulation effectively keeps ice cold for several days
- ◆ Recessed front handle for convenient pulling or lifting
- ◆ No assembly required; oil caster wheel bearings before use
- ◆ 125 lb capacity
- ◆ NSF listed

ITEM	DESCRIPTION	SIZE	UOM	CASE
IIC-29	Ice Caddy w/Sliding Lid	Ext Dim: 23"L x 31.5"W x 29.25"H	Set	1
IIC-C8	Caster For IIC-29	8"Dia	Each	1
IIC-C5B	Brake Caster for IIC-29	5"Dia	Each	1



IIC-SERIES



**CLASSIC CHROME POURERS**

- ◆ Chrome spout
- ◆ Fast flow with plastic breather tube
- ◆ Food-grade poly-plastic cork

ITEM	DESCRIPTION	UOM	CASE
PP-C	Black Collar	Doz	12/48
PP-NC	No Collar	Doz	12/48

**CLASSIC METAL POURERS**

- ◆ Stainless steel breather tube and different pourer opening sizes provide various flow speeds
- ◆ Food-grade poly-plastic cork

ITEM	DESCRIPTION	UOM	CASE
PPM-4	Tapered Spout, Med Flow	Doz	12/48
PPM-4C	Tapered Spout with Hinged Cap, Med/Fast Flow	Doz	12/48
PPM-4G	Gooseneck Spout, Fast Flow	Doz	12/48
PPM-4J	Jet Spout, Extra Fast Flow	Doz	12/48



**POURERS**



PP-C

PP-NC



PPM-4

PPM-4C

PPM-4G

PPM-4J

**UNIVERSAL LIQUOR POURER COVER**

- ◆ NSF listed

ITEM	DESCRIPTION	UOM	CASE
PC-1	Flexible Plastic	Doz	48

**UNIVERSAL LIQUOR POURER COVER**



PC-1

**CHAMPAGNE BOTTLE STOPPER**

- ◆ Keep the fizz and flavor in opened bottles
- ◆ Chrome-coated steel

ITEM	DESCRIPTION	UOM	CASE
CBS-1	1-3/8" Dia	Each	72/288

**BOTTLE STOPPERS**



CBS-1

**WINE BOTTLE STOPPERS**

- ◆ Color-coded collars to match various alcohols
- ◆ Stainless steel clip and food-grade thermoplastic cork

ITEM	DESCRIPTION	UOM	CASE
WBS-R	Red Collar	Doz	12/48
WBS-W	White Collar	Doz	12/48



WBS-SERIES

POURERS



PPA-SERIES



Screened pouring spout for added protection

PP-SERIES



PPR-2-SERIES



PPR-1



MEASURED POURERS

Measured pourers can reduce liquor costs up to 30% by preventing over-pouring. When used correctly, the Winware premium measured pourers provide a fast and accurate pour every time.

- ◆ Color-coded for portion control
- ◆ Also for use with juice or oils
- ◆ New and improved over previous PPOK-series

ITEM	DESCRIPTION	UOM	CASE
PPA-050	1/2 Oz, Orange Tail	Doz	25
PPA-063	5/8 Oz, Black Tail	Doz	25
PPA-075	3/4 Oz, Green Tail	Doz	25
PPA-087	7/8 Oz, Blue Tail	Doz	25
PPA-100	1 Oz, Red Tail	Doz	25
PPA-113	1-1/8 Oz, Purple Tail	Doz	25
PPA-125	1-1/4 Oz, Clear Tail	Doz	25
PPA-150	1-1/2 Oz, Yellow Tail	Doz	25
PPA-200	2 Oz, White Tail	Doz	25



SCREENED POURERS

- ◆ Screened spout keeps bugs and dirt out of bottle
- ◆ Spout is bent at the angle to achieve a perfect pour
- ◆ Available in three (3) colors

ITEM	DESCRIPTION	UOM	CASE
PP-SAM	Gemstone Amber	Doz	12/48
PP-SCL	Crystal Clear	Doz	12/48
PP-SSM	Midnight Smoke	Doz	12/48



ECONOMY FREE-FLOW POURERS

- ◆ Color-coded to help with memorization of drink recipes

ITEM	DESCRIPTION	UOM	CASE
PPR-2B	Blue	Doz	12/72
PPR-2C	Clear	Doz	12/72
PPR-2G	Green	Doz	12/72
PPR-2K	Black	Doz	12/72
PPR-2R	Red	Doz	12/72
PPR-2W	White	Doz	12/72
PPR-2Y	Yellow	Doz	12/72

FLEXIBLE PLASTIC POURER

ITEM	DESCRIPTION	UOM	CASE
PPR-1	Black	Each	12/120

**LIQUOR & JUICE MULTI-POUR SETS**

◆ Six (6) color assortments; two (2) of each color per case

ITEM	DESCRIPTION	UOM	CASE
PPB-1MX	1 Qt	Case	1
PPB-2MX	2 Qt	Case	1

**POUR BOTTLES**



PPB-SERIES

**LIQUOR & JUICE MULTI-POUR BOTTLES**

◆ Each comes with spout & lid

ITEM	DESCRIPTION	UOM	CASE
PPB-1B	1 Qt, Brown	Each	12
PPB-1G	1 Qt, Green	Each	12
PPB-1O	1 Qt, Orange	Each	12
PPB-1R	1 Qt, Red	Each	12
PPB-1W	1 Qt, White	Each	12
PPB-1Y	1 Qt, Yellow	Each	12
PPB-2B	2 Qt, Brown	Each	12
PPB-2G	2 Qt, Green	Each	12
PPB-2O	2 Qt, Orange	Each	12
PPB-2R	2 Qt, Red	Each	12
PPB-2W	2 Qt, White	Each	12
PPB-2Y	2 Qt, Yellow	Each	12



PPB-1B

**PLASTIC FLAIR BOTTLE**

ITEM	DESCRIPTION	UOM	CASE
PFBT-11W	12-1/2"H	Each	4/24



PFBT-11W



**PLASTIC PUMP KIT FOR SYRUP & LIQUEURS**

- ◆ Use for dispensing products such as ketchup, mustard, tartar sauce, dressing, etc.
- ◆ Includes 9" standard size pump
- ◆ 5 lid sizes:
  - 1-9/16" threaded
  - 3-11/16" threaded
  - 4-1/2" threaded
  - 4-1/2" snap on
  - 6-5/16" snap on

ITEM	DESCRIPTION	UOM	CASE
PKT-6	White Pump Kit	Set	12/72

**PUMP KIT FOR SYRUPS & LIQUEURS**



PKT-6





**SPEED RAILS**



SPR-22D



SPR-22S



SPR-1



**BAR SPEED RAILS**

- ◆ Keep the most frequently used bar liquors and drink mixes close at hand
- ◆ Stainless steel
- ◆ Mounting straps sold separately

ITEM	DESCRIPTION	UOM	CASE
SPR-22S	22" Single	Each	1
SPR-22D	22" Double	Each	1/3
SPR-32S	32" Single	Each	1
SPR-32D	32" Double	Each	1/3
SPR-42S	42" Single	Each	1
SPR-42D	42" Double	Each	1/3
SPR-1	Mounting Straps for SPR-series	Each	12/120

**WINE SERVICE**



WB-4



WB-4HV



WB-29S



**4 QT WINE BUCKETS & STAND**

- ◆ Stainless steel mirror finish

ITEM	DESCRIPTION	SIZE	UOM	CASE
WB-4	4 Qt Wine Bucket, No Retail Pkg.	7.5" Dia x 8" H	Each	6/24
WB-4HV	4 Qt Deluxe Wine Bucket	8" Dia x 10" H	Each	1/12
WB-29S	Pipe Style Stand for WB-4 & WB-4HV	28-1/2" H	Each	1/6



WB-8 & WB-8S



WB-12FS OPEN

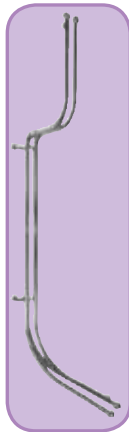

WB-12FS Folded



**8 QT WINE BUCKET & STANDS**

- ◆ Stainless steel mirror finish

ITEM	DESCRIPTION	UOM	CASE
WB-8	8 Qt Wine Bucket*	Each	6/24
WB-8S	Stand for WB-8	Each	1/12
WB-12FS	Folding Stand for WB-8	Each	1/6

\*Assembly required

## WINE SERVICE

### DOUBLE WALL WINE COASTERS

- ◆ Great space saving alternative to wine buckets
- ◆ Can also be used to display light snacks, hors d'oeuvres or desserts on tabletops
- ◆ Satin finish stainless steel
- ◆ Each measures 4-5/8" Dia x 2-5/8"H
- ◆ Fits 3-3/4" diameter wine bottles

ITEM	DESCRIPTION	UOM	CASE
DWCC-5	Smooth	Each	12
DWCC-5H	Hammered	Each	12



DWCC-5



DWCC-5H

### WINE COOLERS

ITEM	DESCRIPTION	SIZE	COLOR	UOM	CASE
WC-60	Double Wall Hourglass, Mirror S/S	6" Dia x 6" H		Each	1/12
WC-7M	Marble, White	5" Dia x 7" H	White	Each	1/6
WC-5	Double Wall, Satin S/S, No Retail Pkg.	4-1/2" Dia x 7-3/4" H		Each	6/24
WC-4A	Acrylic, Clear	4-1/2" Dia x 9-1/4" H	Clear	Each	1/12



WC-60



WC-4A



WC-5



WC-7M

### DOUBLE WALL ICE BUCKET

*Subtle and stylish, this double-walled stainless steel ice bucket prevents condensation and maintains interior temperatures to keep ice colder for longer time periods.*

- ◆ Stainless steel
- ◆ Ideal for hotel rooms
- ◆ Convenient carrying handle and cover

ITEM	DESCRIPTION	UOM	CASE
ICB-60	60 Oz	Each	1/8



ICB-60

## BAR TRAYS



STRS-16

## ROUND SERVICE TRAYS

Made of highly polished stainless steel, these round trays feature a whimsical swirl design, adding a modern flair to even the most traditional drink presentations.

ITEM	DESCRIPTION	UOM	CASE
STRS-12	12"	Each	12/48
STRS-14	14"	Each	12/24
STRS-16	16"	Each	12/24

## NON-SLIP SERVING TRAYS



### DELUXE FIBERGLASS TRAYS

- ◆ High durability fiberglass tray with self-molded peel-resistant non-slip surface
- ◆ Easy to wash by hand, however not recommended to leave soaking in hot water
- ◆ NSF listed



TFG-16N

TFG-2622K

ITEM	DESCRIPTION	SIZE	COLOR	UOM	CASE
TFG-11K	Round	11"	Black	Each	1/12
TFG-11N	Round	11"	Brown	Each	1/12
TFG-14K	Round	14"	Black	Each	1/12
TFG-14N	Round	14"	Brown	Each	1/12
TFG-16K	Round	16"	Black	Each	1/12
TFG-16N	Round	16"	Brown	Each	1/12
TFG-2622K	Oval	26"x 22"	Black	Each	1/6
TFG-2622N	Oval	26"x 22"	Brown	Each	1/6



TFG FIBERGLASS-SERIES



TRH-16

TRH-2722K

## EASY-HOLD RUBBER-LINED PLASTIC TRAYS

- ◆ NSF listed

ITEM	DESCRIPTION	SIZE	COLOR	UOM	CASE
TRH-11	Round	11"	Brown	Each	12
TRH-11K	Round	11"	Black	Each	12
TRH-14	Round	14"	Brown	Each	12
TRH-14K	Round	14"	Black	Each	12
TRH-16	Round	16"	Brown	Each	12
TRH-16K	Round	16"	Black	Each	12
TRH-1418	Rectangular	14"x 18"	Brown	Each	12
TRH-1418K	Rectangular	14"x 18"	Black	Each	12
TRH-2722	Oval	22"x 27"	Brown	Each	1/6
TRH-2722K	Oval	22"x 27"	Black	Each	1/6



TRH PLASTIC-SERIES



TCK-16



## PLASTIC CORK-LINED TRAYS

ITEM	DESCRIPTION	UOM	CASE
TCK-14	14" Round	Each	12/48
TCK-16	16" Round	Each	12/36
TCK-14CK	Replacement Cork for CK-14	Each	50/350
TCK-16CK	Replacement Cork for CK-16	Each	50/350

**MULTI-CHANNEL GLASS HANGERS**

- ◆ Chrome-plated

ITEM	DESCRIPTION	SIZE	UOM	CASE
GHC-1836	8 Channels	18" x 36" x 4"	Each	2/4
GHC-1848	11 Channels	18" x 48" x 4"	Each	2/4

**OVERHEAD GLASS RACKS**

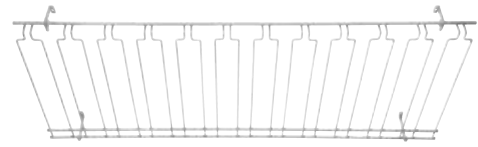

GHC-1848  
(11 CHANNELS)

**SINGLE-CHANNEL GLASS HANGERS**

ITEM	DESCRIPTION	SIZE	UOM	CASE
GH-10	Brass Plated	10"	Each	12/72
GH-16	Brass Plated	16"	Each	12/72
GH-24	Brass Plated	24"	Each	12/48
GHC-10	Chrome Plated	10"	Each	12/72
GHC-16	Chrome Plated	16"	Each	12/72
GHC-24	Chrome Plated	24"	Each	12/48



GH-16



GHC-16

**BAR LINERS**

- ◆ Roll measures 2'W x 40'L
- ◆ Available in assorted colors
- ◆ BPA-free

ITEM	DESCRIPTION	UOM	CASE
BL-240C	Clear	Roll	1/2
BL-240G	Green	Roll	1/2
BL-240K	Black	Roll	1/2
BL-240R	Red	Roll	1/2
BL-240W	White	Roll	1/2

**BAR LINERS & SERVICE MATS**



BL-SERIES



**BAR SERVICE MATS**

- ◆ Measures 12" x 18"
- ◆ NSF listed

ITEM	DESCRIPTION	UOM	CASE
BM-1812B	Brown	Each	12
BM-1812K	Black	Each	12

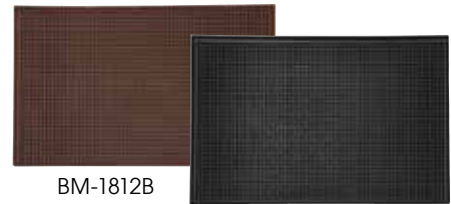

BM-1812B

BM-1812K

BM-SERIES



**INTERLOCKING BAR MATS**

- ◆ Measures 12" x 12"
- ◆ Cuts easily to fit any counter shape
- ◆ Lightweight and dishwasher safe
- ◆ NSF listed

ITEM	DESCRIPTION	UOM	CASE
BML-12C	Clear	Each	12/24
BML-12K	Dark Smoke	Each	12/24

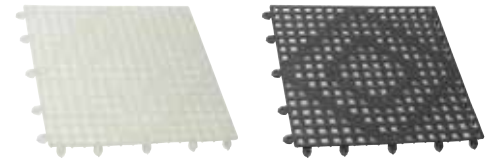

BML-12C

BML-12K

BML-SERIES



**BAR RAIL SPILL MATS**

- ◆ Measures 3-1/4" x 27"

ITEM	DESCRIPTION	UOM	CASE
BM-327B	Brown	Each	12/48
BM-327K	Black, NSF	Each	12/48



BM-327B



BM-327K





BAR CLEAN-UP



SAS-4

MAS-4K

MAS-4R



GWB-3

GWB-3-BR



GWB-1



BTGP-21



BTH-2028G



BTM-16AC



Package comes with hanging hook



BTM-16W



BTW-30



OP-7

STAINLESS STEEL ASHTRAY

ITEM	DESCRIPTION	UOM	CASE
SAS-4	4"Dia, Stackable	Each	24/96



ASHTRAYS

- ◆ Heat resistant up to 338°F (170°C)

ITEM	DESCRIPTION	UOM	CASE
MAS-4K	4"Dia, Black	Doz	12
MAS-4R	4"Dia, Red	Doz	12

GLASS WASHER BRUSHES

- ◆ Four (4) suction feet provide stability on slippery surfaces
- ◆ Dishwasher safe

ITEM	DESCRIPTION	UOM	CASE
GWB-3	3 Brushes with Base	Each	1/12
GWB-3-BR	Brush for GWB-3	Each	1/100



BEER MUG WASHER

*Eliminate hand-scrubbing glassware with Winco's Beer Mug Washer. The long-lasting nylon bristles are tough enough to get out grime, yet soft enough that they will not scratch or damage glass. Four suction feet hold to surfaces, preventing movement while in use.*

- ◆ Features one glass washer in the center with additional scrubbing bristles on the sides
- ◆ Wide enough to accommodate a beer mug & the handle
- ◆ Dirty water can be drained through detachable hose
- ◆ Durable plastic construction at space-saving size

ITEM	DESCRIPTION	UOM	CASE
GWB-1	Manual Mug Washer	Each	1/6



GLASS POLISHING TOWEL

- ◆ 100% cotton w/red pinstripes
- ◆ Lint-free and non-abrasive to eliminate streaking, yet is gentle on glassware
- ◆ Thousands of microscopic fibers pick up dirt and dust
- ◆ Absorbs seven times its weight in liquids, also ideal for countertops and tabletops

ITEM	DESCRIPTION	UOM	CASE
BTGP-21	16" x 29"	Doz	10/20



HERRINGBONE BAR TOWEL

- ◆ 100% cotton, super absorbent
- ◆ Green stripe provides easy designation of towel for specific use to prevent cross-contamination

ITEM	DESCRIPTION	UOM	CASE
BTH-2028G	20" x 28"	Doz	10/20



MICROFIBER TOWELS

- ◆ Lightweight, super absorbent and quick drying
- ◆ Multi-color pack contains white, green, yellow, brown, orange and red towels
- ◆ Dimensions: 16" x 16"
- ◆ Each pack contains six (6) towels

ITEM	DESCRIPTION	UOM	CASE
BTM-16AC	Assorted Colors	Pack	1/20
BTM-16W	White	Pack	1/20



WHITE BAR TOWEL

- ◆ 100% cotton

ITEM	DESCRIPTION	UOM	CASE
BTW-30	16" x 19"	Doz	10/20

OVERFLOW PIPES

ITEM	DESCRIPTION	UOM	CASE
OP-7	7" x 1"Dia	Each	24/288
OP-11	11" x 1"Dia	Each	12/144



# KITCHEN

*Prep & Cook*



## ACERO FORGED CUTLERY



Our Acero forged series offers exceptional commercial quality at never-before-seen prices.

- ◆ Fully forged, full-tang construction
- ◆ Made of X50 Cr MoV15 German steel
- ◆ Unique POM injection molded handles help to achieve balanced weight distribution for ease of use
- ◆ 6-spot advanced polishing allows for a more comfortable grip
- ◆ Easy edge maintenance and rapid sharpening
- ◆ NSF listed

ITEM	DESCRIPTION	BLADE	UOM	CASE
KFP-30	Peeling Knife	2-3/4" L	Each	6/72
KFP-35	Paring Knife	3-1/2" L	Each	6/72
KFP-50	Utility Knife	5" L	Each	6/72
KFP-51	Tomato Knife	5" L	Each	6/72
KFP-61	Boning Knife	6" L	Each	6/36
KFP-70	Santoku Knife	7" L	Each	6/36
KFP-73	Nakiri Knife	7" L	Each	6/36



KFP-30



KFP-35



KFP-50



KFP-51



KFP-61



KFP-70



KFP-73

NSF KFP-SERIES

**X50 CR MOV15  
GERMAN STEEL**  
**FULLY FORGED, FULL TANG**  
**UNIQUE POM HANDLE**



# ACERO FORGED CUTLERY

## CHEF'S KNIVES

◆ NSF listed

ITEM	DESCRIPTION	BLADE	UOM	CASE
KFP-60	Chef's Knife	6" L	Each	6/36
KFP-80	Chef's Knife	8" L	Each	6/36
KFP-84	Chef's Knife, Hollow Ground	8" L	Each	6/36
KFP-85	Chef's Knife, Short Bolster	8" L	Each	6/36
KFP-100	Chef's Knife	10" L	Each	6/36
KFP-103	Chef's Knife, Hollow Ground	10" L	Each	6/36
KFP-104	Chef's Knife Short Bolster	10" L	Each	6/36
KFP-120	Chef's Knife	12" L	Each	6/36



KFP-SERIES 

FULLY FORGED BLADE



KFP-60



KFP-80



KFP-84



KFP-85

**AVAILABLE IN MARCH 2018**



KFP-100



KFP-103



KFP-104



KFP-120



**ACERO FORGED CUTLERY**

◆ NSF listed

ITEM	DESCRIPTION	BLADE	UOM	CASE
KFP-74	Fillet Knife, Flexible	7" L	Each	6/36
KFP-83	Bread Knife, Offset	8" L	Each	6/36
KFP-82	Bread Knife	8" L	Each	6/36
KFP-81	Slicer	8" L	Each	6/36
KFP-101	Slicer, Granton Edge	10" L	Each	6/36
KFP-102	Fish/Roast Slicer, Granton Edge	10" L	Each	6/36

**ACERO FORGED CUTLERY**



AVAILABLE IN MARCH 2018

NSF KFP-SERIES



**ACERO FORGED COOK'S FORKS**

◆ Extra heavyweight  
◆ NSF listed

ITEM	DESCRIPTION	BLADE	UOM	CASE
KFP-71	Straight, 12" w/Hdl	6"L	Each	6/36
KFP-62	Curved, 12" w/Hdl	6"L	Each	6/36
KFP-121	Curved, 12" w/Hdl	4"L	Each	6/36
KFP-140	Curved, 14" w/Hdl	5"L	Each	6/36
KFP-180	Curved, 18" w/Hdl	5"L	Each	6/36

AVAILABLE IN FEBRUARY 2018

NSF KFP-SERIES



ACERO FORGED CUTLERY



**ACERO KNIFE BLOCK SET**

Designed to outfit any kitchen, the 7-piece forged knife block set is stocked with essential cutlery for all food prep tasks. The space-saving knife block is comprised of top-of-the-line tools, including bonus kitchen shears. Storing knives in a block is a convenient way to preserve the knives' sharp edges.

◆ Knives included are NSF listed

ITEM	DESCRIPTION	UOM	CASE
KFP-BLKA	7-Pc Knife Block Set	Set	1/4

Includes:

- ◆ 3.5" Paring Knife (KFP-35)
- ◆ 5" Utility Knife (KFP-50)
- ◆ 6" Boning Knife (KFP-61)
- ◆ 8" Chef Knife (KFP-80)
- ◆ 8" Bread Knife (KFP-82)
- ◆ 8" Sharpening Steel
- ◆ Wooden Knife Block
- ◆ Bonus Shears (KS-06)



KFP-BLKA KNIVES NSF

**ACERO KNIFE KIT**

This 8-piece forged knife kit allows any chef to carry cutlery with ease in our heavy-duty, zip-up carry case, and is ideal for storing knives when not in use. Kit includes 7 commercial-quality knives and bonus kitchen shears.

◆ Knives included are NSF listed

ITEM	DESCRIPTION	UOM	CASE
KFP-KITA	7-Pc Knife Kit	Set	1/6

Includes:

- ◆ 3.5" Paring Knife (KFP-35)
- ◆ 6" Boning Knife (KFP-61)
- ◆ 8" Chef Knife (KFP-80)
- ◆ 8" Bread Knife (KFP-82)
- ◆ 10" Slicer (KFP-101)
- ◆ 12" Sharpening Steel (KFP-122)
- ◆ 11-slot Knife Bag (KBG-11)
- ◆ Bonus Shears (KS-06)



KFP-KITA KNIVES NSF

**ACERO DIAMOND STEEL SHARPENERS**

Durable and long lasting, these diamond coated steel rods sharpen knives faster than conventional stones. The extra-fine grit allows for regular honing or final polishing.

◆ NSF listed

ITEM	DESCRIPTION	LENGTH	UOM	CASE
KFP-122	20mm Width, Oval	12"	Each	6/24
KFP-123	12mm Dia, Round	12"	Each	6/24



KFP-122



Shape of KFP-122



KFP-123

KFP-SHARPENERS NSF

# STÄL STAMPED CUTLERY



Stäl series, our most economically priced line, offers the same level of quality and performance as others costing twice as much.

- ◆ Razor-sharp X50 Cr MoV15 German steel blade
- ◆ Ergonomically designed slip-resistant, stain-free white polypropylene handles offer exceptional comfort, reducing arm and hand fatigue
- ◆ Protective finger guard
- ◆ Easy edge maintenance and rapid sharpening
- ◆ NSF listed

ITEM	DESCRIPTION	BLADE	UOM	CASE
KWP-30	Paring Knife, 2-Pcs/Pk	3-1/4" L	Pack	6/24
KWP-31	Serrated Paring Knife, 2-Pcs/Pk	3-1/2" L	Pack	6/24
KWP-50	Utility Knife, Wavy Edge	5-1/2" L	Each	6/36
KWP-63	Utility Knife, Wavy Edge	6" L	Each	6/36
KWP-60	Boning Knife, Flexible	6" L	Each	6/36
KWP-61	Boning Knife, Narrow	6" L	Each	6/36
KWP-62	Boning Knife, Wide	6" L	Each	6/36
KWP-92	Offset Utility/Bread Knife	9" L	Each	6/36
KWP-91	Bread Knife	9-1/2" L	Each	6/36
KWP-90	Cimeter Steak Knife	9-1/2" L	Each	6/36



2PCS PER PACK



KWP-30



KWP-31



KWP-50



KWP-63



KWP-60



KWP-61



KWP-62



KWP-92



KWP-91



KWP-90

NSF KWP-SERIES

X50 CR MOV15  
GERMAN STEEL  
HIGH CARBON  
STAIN RESISTANT



**STÄL CHEF'S KNIVES**

◆ NSF listed

ITEM	DESCRIPTION	BLADE	UOM	CASE
KWP-70	Santoku	7" L	Each	6/36
KWP-80	Chef's Knife	8" L	Each	6/36
KWP-81	Hollow Ground	8" L	Each	6/36
KWP-100	Chef's Knife	10" L	Each	6/36
KWP-101	Hollow Ground	10" L	Each	6/36

**STÄL STAMPED CUTLERY**



KWP-70



KWP-80



KWP-81



KWP-100



KWP-101

KWP-SERIES **NSF**

**STÄL STAMPED CUTLERY**

◆ NSF listed

ITEM	DESCRIPTION	BLADE	UOM	CASE
KWP-93	Hollow Ground Cimenter	9-1/2" L	Each	6/36
KWP-121	Slicer, Wavy Edge	12" L	Each	6/36
KWP-122	Roast Beef Slicer	12" L	Each	6/36
KWP-123	Hollow Ground Slicer	12" L	Each	6/36



KWP-93



KWP-121



KWP-122



KWP-123

KWP-SERIES **NSF**





NSF KWP-COLOR SERIES

X50 CR MOV15  
GERMAN STEEL  
HIGH CARBON  
STAIN RESISTANT

SEE PG. 247  
FOR COLOR-CODED  
CUTTING BOARDS

## STÄL COLORED HANDLES

A selection of Stäl knives now come with HAACP color-coded non-slip handles for preventing cross-contamination and a variety of other uses around the kitchen.

- ◆ Razor-sharp X50 Cr MoV15 German steel blade
- ◆ Ergonomically designed slip-resistant stain-free polypropylene handles offer exceptional comfort and reduce arm and hand fatigue
- ◆ Protective finger guard
- ◆ Easy edge maintenance and rapid sharpening
- ◆ NSF listed

HAACP STANDARD COLOR-CODING SYSTEM		
Raw Meats	Raw Poultry	Vegetable & Fruit
Bakery & Dairy	Cooked Meats	Seafood

2PCS PER  
PACK



KWP-30R

### 3-1/4" PARING KNIFE

ITEM	DESCRIPTION	UOM	CASE
KWP-30R	Red, 2-Pcs/Pk	Pack	6/36
KWP-30Y	Yellow, 2-Pcs/Pk	Pack	6/36
KWP-30G	Green, 2-Pcs/Pk	Pack	6/36
KWP-30N	Brown, 2-Pcs/Pk	Pack	6/36
KWP-30U	Blue, 2-Pcs/Pk	Pack	6/36



KWP-60R

### 6" FLEXIBLE BONING KNIFE

ITEM	DESCRIPTION	UOM	CASE
KWP-60R	Red	Each	6/36
KWP-60Y	Yellow	Each	6/36
KWP-60G	Green	Each	6/36
KWP-60N	Brown	Each	6/36
KWP-60U	Blue	Each	6/36



KWP-61R

### 6" NARROW BONING KNIFE

ITEM	DESCRIPTION	UOM	CASE
KWP-61R	Red	Each	6/36
KWP-61Y	Yellow	Each	6/36
KWP-61G	Green	Each	6/36
KWP-61N	Brown	Each	6/36
KWP-61U	Blue	Each	6/36

## STÄL COLORED HANDLES

### 7" SANTOKU KNIFE

ITEM	DESCRIPTION	UOM	CASE
KWP-70R	Red	Each	6/36
KWP-70Y	Yellow	Each	6/36
KWP-70G	Green	Each	6/36
KWP-70N	Brown	Each	6/36
KWP-70U	Blue	Each	6/36



KWP-70R

### 8" CHEF'S KNIFE

ITEM	DESCRIPTION	UOM	CASE
KWP-80R	Red	Each	6/36
KWP-80Y	Yellow	Each	6/36
KWP-80G	Green	Each	6/36
KWP-80N	Brown	Each	6/36
KWP-80U	Blue	Each	6/36



KWP-80R

### 9" OFFSET BREAD KNIFE

ITEM	DESCRIPTION	UOM	CASE
KWP-92R	Red	Each	6/36
KWP-92Y	Yellow	Each	6/36
KWP-92G	Green	Each	6/36
KWP-92N	Brown	Each	6/36
KWP-92U	Blue	Each	6/36



KWP-92R

### 10" CHEF'S KNIFE

ITEM	DESCRIPTION	UOM	CASE
KWP-100R	Red	Each	6/36
KWP-100Y	Yellow	Each	6/36
KWP-100G	Green	Each	6/36
KWP-100N	Brown	Each	6/36
KWP-100U	Blue	Each	6/36



KWP-100R

### 12" WAVY EDGE SLICER KNIFE

ITEM	DESCRIPTION	UOM	CASE
KWP-121R	Red	Each	6/36
KWP-121Y	Yellow	Each	6/36
KWP-121G	Green	Each	6/36
KWP-121N	Brown	Each	6/36
KWP-121U	Blue	Each	6/36



KWP-121R

KWP-COLOR SERIES 

STÄL KNIFE KIT



STÄL KNIFE KIT

Carry and store knives in style with the convenient and travel-friendly knife roll-up storage bag. Includes 6 razor sharp, German steel stamped knives, a sharpening steel and bonus nylon spoon.

◆ Knives are NSF listed

ITEM	DESCRIPTION	UOM	CASE
KWP-KIT1	7-Pc Knife Kit	Set	1/6

Includes:

- ◆ 3.25" Paring Knife (KWP-30)
- ◆ 5.5" Utility Knife (KWP-50)
- ◆ 6" Boning Knife, Flexible (KWP-60)
- ◆ 9.5" Offset Bread/Utility Knife (KWP-91)
- ◆ 10" Hollow Ground Chef Knife (KWP-101)
- ◆ 12" Wavy Edge Slicer (KWP-121)
- ◆ 12" Sharpening Steel (K-12S)
- ◆ 11-slot Knife Bag (KBG-11)
- ◆ Bonus Red Nylon Spoon (NS-12R)



NSF KWP-KIT1 KNIVES

STÄL PARING KNIFE BULK PACK



Includes 7 handle colors

STÄL PARING KNIFE BULK PACK

The ultra-useful paring knife now comes in bulk, packed in a convenient display bucket, perfect for impulse purchases! Available in an assortment of seven different colored handles.

- ◆ 3-1/4" paring knife made of X50 Cr Mo V15 German Steel
- ◆ Ergonomic, slip-resistant polypropylene handle is comfortable and reduces hand fatigue
- ◆ Protective finger guard
- ◆ NSF listed

ITEM	DESCRIPTION	UOM	CASE
KWP-3046	46-Pc/Pk	Pack	1/4

NSF KWP-3046

WINCO® SPREADER BULK PACK



Includes 7 handle colors

WINCO® SPREADER BULK PACK

Practical for many uses around the kitchen, the spreader is now available in bulk. Packed in a convenient display bucket for impulse purchase positioning.

- ◆ Assortment of seven (7) colors included in convenient display bucket
- ◆ 3-5/8" spreader with stainless steel, satin finish blade
- ◆ Slip-free comfort grip
- ◆ NSF listed

ITEM	DESCRIPTION	UOM	CASE
TWP-3135	35-Pc/Pk	Pack	1/4

NSF TWP-3135

**ACERO DIAMOND STEEL SHARPENERS**

Durable and long lasting, these diamond coated steel rods sharpen knives faster than conventional stones. The extra-fine grit allows for regular honing or final polishing.

◆ NSF listed

ITEM	DESCRIPTION	LENGTH	UOM	CASE
KFP-122	20mm Width, Oval	12"	Each	6/24
KFP-123	12mm Dia, Round	12"	Each	6/24

**PREMIUM SHARPENING STEELS**

Made of super hard HRC59-63 steel, these magnetic sharpening steels attract metal shavings during the sharpening process to prevent debris from sticking to knives and getting onto food.

ITEM	DESCRIPTION	LENGTH	UOM	CASE
K-34S	13mm Dia, Round	14"	Each	6/24
K-54S	22mm Width, Oval	14"	Each	6/24

**SHARPENING STEELS**

ITEM	DESCRIPTION	LENGTH	UOM	CASE
K-12S	Stainless Steel	12"	Each	12/48
K-14S	Stainless Steel	14"	Each	12/48

**COMBINATION SHARPENING STONE**

- ◆ Top-grade carbonized silicon
- ◆ Fine and medium grain

ITEM	DESCRIPTION	UOM	CASE
SS-821	8"L x 2"W x 1"H	Each	1/24
SS-1211	12"L x 2-1/2"W x 1-1/2"H, No Retail Pkg	Each	1/12

**SHARPENING GUIDE WITH CERAMIC INSERTS**

Sharpening knives has never been easier! Sharpening guides by Winco keep knives at the optimal angle while using sharpening stones.

- ◆ Ideal sharpening angle for ultimate knife performance
- ◆ Durable plastic body with protective ceramic inserts
- ◆ For use with 6" and larger chef's knives

ITEM	DESCRIPTION	UOM	CASE
K-4G	Sharpening Guide	Each	12/144

**SHARPENING STEELS**



KFP-122



Shape of KFP-122



KFP-123

KFP-SHARPENERS **NSF**



K-34S



K-54S

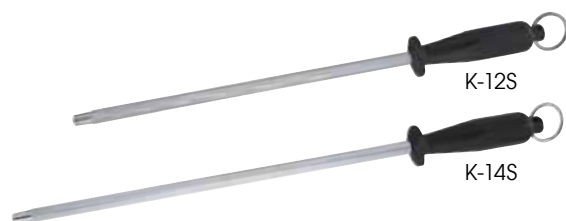
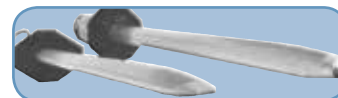

K-12S

K-14S

**SHARPENING TOOLS**

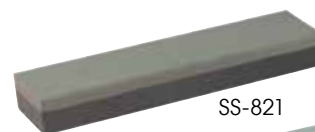

SS-821



SS-1211



K-4G



K-4G In Use



## SHARPENING TOOLS



STANDARD OR ASIAN KNIVES  
COARSE OR FINE STAGES



Packaging



### FOUR-STAGE KNIFE SHARPENER

No matter if you prefer standard or Asian styled knives, Winco's Four-Stage Sharpener offers one tool to do the job. Designed for the commercial kitchen, the wide, rubberized base provides the stability for any busy chef to sharpen their favored knife.

- ◆ For either standard or Asian style knives, coarse stages quickly sharpen dull knives, while fine stages hone to a razor sharp edge
- ◆ Reduced wobbling - the safest sharpener with oversized non-slip base
- ◆ Most ergonomic handle available for comfort, slip-resistance and grip control

ITEM	DESCRIPTION	UOM	CASE
KSP-4	9-7/8"L x 2-5/8"W x 3-3/4"H	Each	12/24



KSP-2

### DUAL-STAGE KNIFE SHARPENER

- ◆ Soft-grip ergonomic handle with non-skid base
- ◆ Coarse carbide steel blades for sharpening and ceramic rods for honing

ITEM	DESCRIPTION	UOM	CASE
KSP-2	7-5/8"L x 2-1/2"W x 2"H	Each	12/48

## KNIFE BLADE GUARDS

AVAILABLE IN MARCH 2018



### KNIFE BLADE GUARDS

Safely store and transport knives with the durable blade guards from Winco®.

- ◆ Ideal for stamped or forged blades
- ◆ Felt interior prevents dulling

NEW



KGD-41

NEW



KGD-815

ITEM	DESCRIPTION	SIZE	UOM	CASE
KGD-41	Fits 2-1/2" to 3-1/2" blade, 2-Pcs/Pk	4" x 1"	Pack	12/72
KGD-61	Fits 5" to 6" blade, 2-Pcs/Pk	6" x 1"	Pack	12/72
KGD-62	Fits 6" blade	6" x 2"	Each	12/72
KGD-815	Fits 7" to 8" blade	8" x 1-1/2"	Each	12/72
KGD-82	Fits 7" to 8" blade	8" x 2"	Each	12/72
KGD-1015	Fits 10" blade	10" x 1-1/2"	Each	12/72
KGD-102	Fits 9" to 10" blade	10" x 2"	Each	12/72
KGD-122	Fits 11" to 12" blade	12" x 2"	Each	12/72

Can be used with bolsters and angled-handle knives



KGD-41 with KWP-30 knife



KGD-815 with KFP-80 knife

### KITCHEN SHEARS

ITEM	DESCRIPTION	UOM	CASE
KS-01	All purpose	Each	12/120
KS-06*	All purpose, Detachable	Each	12/72

\*Replaces former KS-04

### KITCHEN SHEARS



KS-01



KS-06



Detachable

### POULTRY SHEARS

ITEM	DESCRIPTION	UOM	CASE
KS-02	Soft PP Hdl	Each	12/72
KS-03	Stainless Steel	Each	10/50



KS-03



KS-02

### HERB SHEARS

Chopping fresh herbs is now easy with these shears featuring five (5) durable stainless steel blades.

- ◆ Works well on basil, thyme, mint and more
- ◆ Ideal for cutting, chopping and mincing herbs
- ◆ Comfortable PP and TPR handles for easy grip

ITEM	DESCRIPTION	UOM	CASE
KS-05	5-Layer Blade	Each	12/72



Easily cut, chop, and mince herbs



KS-05

### STAINLESS STEEL PROTECTIVE MESH GLOVES

Made for meat processing, the rust-resistant 304L stainless steel rings that form these mesh gloves protect hands from cuts and punctures while deboning and butchering. Each glove is reversible and is fixed with a wrist strap that features a snap and cinch fastener to keep it secure.

- ◆ Light-weight and non-corrosive
- ◆ Wrist length

ITEM	DESCRIPTION	UOM	CASE
PMG-1S	Small, White Strap	Each	10/50
PMG-1M	Medium, Red Strap	Each	10/50
PMG-1L	Large, Blue Strap	Each	50

### PROTECTIVE GLOVES



Closure Detail

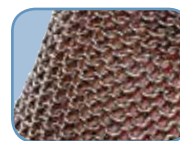

Mesh Detail



PMG-1L

### CUT-RESISTANT GLOVES

- ◆ Resistant to serrated blades and punctures during food preparation
- ◆ High density poly/glass fibers are woven into a comfortably fitted glove
- ◆ Highly elasticized fit allows for a better grip and handling

ITEM	DESCRIPTION	UOM	CASE
GCR-M	Medium	Each	12/120
GCR-L	Large	Each	12/120

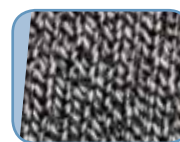

Fabric Detail



GCR-M

PROFESSIONAL CLEAVERS

NSF KFP-72



KC-301

NSF KC-401



NSF KC-501



NSF KC-601



KC-101



KC-201R

ACERO EXTRA HEAVY-DUTY CLEAVER

- ◆ Full tang true forged blade
- ◆ Triple riveted handle
- ◆ NSF listed

ITEM	DESCRIPTION	UOM	CASE
KFP-72	7"L x 4-3/8"W Blade	Each	6/24

HEAVY-DUTY CLEAVER

- ◆ Wooden handle

ITEM	DESCRIPTION	UOM	CASE
KC-301	8"L x 3-1/2"W Blade	Each	6/24

STEEL HANDLE CHINESE CLEAVERS

- ◆ NSF listed

ITEM	DESCRIPTION	UOM	CASE
KC-401	8-1/4"L x 4"W Blade	Each	12/36
KC-501	8"L x 2-1/4"W Blade	Each	10/50

POM HANDLE CHINESE CLEAVER

- ◆ NSF listed

ITEM	DESCRIPTION	UOM	CASE
KC-601	8"L x 3-1/2"W Blade	Each	6/36

WOODEN HANDLE CHINESE CLEAVERS

ITEM	DESCRIPTION	UOM	CASE
KC-101	8"L x 3-1/2"W Blade	Each	12/24
KC-201R	7"L x 2"W Blade	Each	12/48



POT FORKS



KPF-612



KPF-210

POT FORKS

ITEM	DESCRIPTION	UOM	CASE
KPF-612	12-5/8" O.L.	Each	12/120
KPF-210	21-7/8" O.L.	Each	12/72

PARING KNIFE



NSF K-40P

PARING KNIFE

- ◆ PP Handle
- ◆ NSF listed

ITEM	DESCRIPTION	UOM	CASE
K-40P	3"L Blade	Each	12/360

KNIFE STORAGE



KR-9

STAINLESS STEEL KNIFE RACK

- ◆ Hooks onto wall

ITEM	DESCRIPTION	UOM	CASE
KR-9	7 Slots	Each	1/12

MAGNETIC KNIFE BARS

ITEM	DESCRIPTION	UOM	CASE
WMB-12	12", Wooden Base	Each	1/36
WMB-18	18", Wooden Base	Each	1/24
WMB-24	24", Wooden Base	Each	1/24
PMB-13	13", Plastic Base	Each	1/36
PMB-18	18", Plastic Base	Each	1/36
PMB-24	24", Plastic Base	Each	1/24



WMB-18



PMB-18



**KNIFE BACKPACK & INNER CASE**

For the chef-on-the-go, Winco® introduces the ideal, multi-functional backpack. As a stand-alone, the backpack has an array of useful features, from laptop sleeve to audio interface. Used with the knife case, this combo easily solves every chef's dilemma of how to safely and securely transport knives.

- ◆ Backpack features wide, ergonomic straps with a back airflow system for extra comfort
- ◆ Padded laptop sleeve compartment with locking zippers
- ◆ Perfectly accommodates Winco's KBP-2 hard case
- ◆ The KBP-2 hard case has 10 slots to fit a variety of knives; has removable strap, which can be used for carrying without backpack

ITEM	DESCRIPTION	UOM	CASE
KBP-1	Backpack	Each	12
KBP-2	Inner Case	Each	12
KBP-S	Backpack w/Inner Knife Case	Set	4

**KNIFE BACKPACK & INNER CASE**



KBP-S

Backpack and Inner Case set



HARD CASE

KBP-2



Easy-access lined top pocket fits glasses or cell phone

Wide, ergonomic shoulder straps with zippered stash pocket

Lockable zippers on compartment that fits a standard laptop

Securely lock zippers on large main compartment

Audio interface and zipper pocket on front

Airflow back system for extra comfort

Internal zipper pockets for wallet or valuables

Wide mesh pocket on each side, great for water bottle



KBP-1

**KNIFE BAGS**

ITEM	DESCRIPTION	UOM	CASE
KBG-8	8 Slot Knife Roll	Each	30
KBG-11*	11 Slot Knife Bag	Each	12
KBG-29	29 Slot Triple-Zip Knife Bag	Each	12

\* Replaces former KBG-10

**KNIFE BAGS**



KBG-29



KBG-11



KBG-8



IMPROVED





# SPATULAS & TURNERS

- ◆ Stainless steel, satin finish blade
- ◆ Ergonomic handle with slip-free comfort grip reduces hand fatigue
- ◆ Dishwasher safe
- ◆ NSF listed (TNH-Series)

**SAME QUALITY AS OTHERS FOR MUCH LESS**



DESCRIPTION	BLADE SIZE (L X W)	UOM	HIGH-HEAT ORANGE NYLON ERGO HANDLE		WOODEN HANDLE	
			ITEM	CASE	ITEM	CASE
Mini Turner	2" x 2-1/4"	* Each			TN32	12/120
Sandwich Spreader	3-5/8" x 1-1/4"	Each			TN713	12/144
Small Scraper	4-1/2" x 3-1/8"	Each			TN526	12/72
Large Scraper	4-7/8" x 4"	Each			TN54	12/72
Steak/Burger Turner	4-1/8" x 3-3/4"	* Each			TN46	12/72
Turner	8" x 4"	Each	TNH-42	12/48	TN48	12/24
Grill Spatula	4-1/4" x 2-3/16"	* Each			TN165	12/72
Teppanyaki Turner, Full Tang	4" x 3-1/2"	* Each			TN43	12/72
Pie Server	4-5/8" x 2-3/8"	* Each			TN166	12/72
Fish Spatula	6-3/4" x 3-1/4"	Each	TNH-60	12/144	FST-6	12/144
Hamburger Turner	5-1/8" x 2-7/8"	* Each	TNH-61	12/72	TN719	12/72
Extra Heavy Turner, Cutting Edge Blade	5" x 6"	* Each	TNH-63	12/48	TN56	12/48
Square Edge Turner	6-1/4" x 3"	* Each	TNH-64	12/72		
Square Edge Turner	7-1/4" x 3"	* Each	TNH-70	12/48		
Flexible Turner	8-1/4" x 2-7/8"	* Each	TNH-90	12/48	TN249	12/48
Flexible Turner (Perforated Blade)	8-1/4" x 2-7/8"	* Each	TNH-91	12/48	TN409	12/48
Offset Giant Turner	8-1/2" x 2-7/8"	* Each			TN44	12/48
Offset Spatula	3-1/2" x 3/4"	* Each			TOS-4	24/288
Offset Spatula	6-1/2" x 1-5/16"	* Each			TOS-7	12/144
Offset Spatula	8-1/2" x 1-1/2"	* Each			TOS-9	12/72
Bakery Spatula	4" x 3/4"	Each			TNS-4	24/288
Bakery Spatula	7-15/16" x 1-1/4"	Each			TNS-7	12/144
Bakery Spatula	10" x 1-3/8"	Each			TNS-9	12/72

\*Measurement reflects blade size not including offset

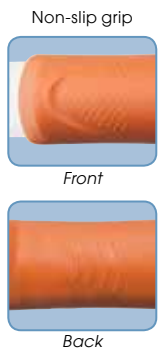
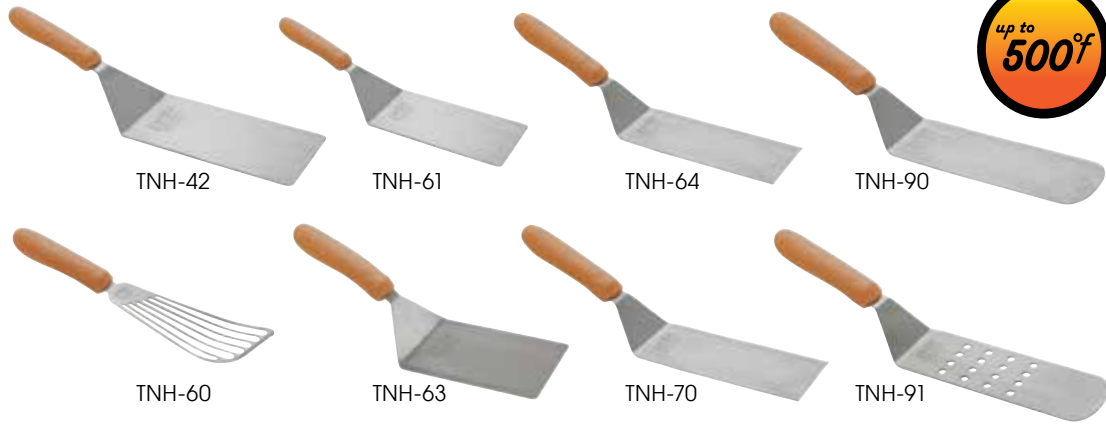

**NSF** TNH-SERIES (ORANGE)



TN32 TN713 TN526 TN54 TN46 TN48 TN165 TN43 TN166 FST-6 TN719 TN56 TN249 TN409 TN44

Relative size comparisons shown

# SPATULAS & TURNERS

- ◆ Stainless steel, satin finish blade
- ◆ Ergonomic handle with slip-free comfort grip reduces hand fatigue
- ◆ Dishwasher safe
- ◆ NSF listed



TKP-SERIES (BLACK) **NSF**  
 TWP-SERIES (WHITE) **NSF**

DESCRIPTION	BLADE SIZE (L X W)	UOM	BLACK ERGO HANDLE		WHITE ERGO HANDLE	
			ITEM	CASE	ITEM	CASE
Mini Turner	2" x 2-1/4"	* Each	TKP-30	12/120	TWP-30	12/120
Sandwich Spreader	3-5/8" x 1-1/4"	Each	TKP-31	12/144	TWP-31	12/144
Small Scraper	4-1/2" x 3-1/8"	Each	TKP-32	12/72	TWP-32	12/72
Large Scraper	4-7/8" x 4"	Each	TKP-40	12/72	TWP-40	12/120
Steak/Burger Turner	4-1/8" x 3-3/4"	* Each	TKP-41	12/72	TWP-41	12/72
Turner	8" x 4"	Each	TKP-42	12/48	TWP-42	12/48
Grill Spatula	4-1/4" x 2-3/16"	* Each	TKP-50	12/72	TWP-50	12/72
Pie Server	4-5/8" x 2-3/8"	* Each	TKP-51	12/72	TWP-51	12/72
Fish Spatula	6-3/4" x 3-1/4"	Each	TKP-60	12/144	TWP-60	12/144
Hamburger Turner	5-1/8" x 2-7/8"	* Each	TKP-61	12/72	TWP-61	12/72
Extra Heavy Turner, Cutting Edge Blade	5" x 6"	* Each	TKP-63	12/48		
Flexible Turner	8-1/4" x 2-7/8"	* Each	TKP-90	12/72	TWP-90	12/48
Flexible Turner (Perforated Blade)	8-1/4" x 2-7/8"	* Each	TKP-91	12/72	TWP-91	12/48
Offset Spatula	3-1/2" x 3/4"	* Each	TKPO-4	24/288	TWPO-4	24/288
Offset Spatula	6-1/2" x 1-5/16"	* Each	TKPO-7	12/144	TWPO-7	12/144
Offset Spatula	8-1/2" x 1-1/2"	* Each	TKPO-9	12/144	TWPO-9	12/144
Bakery Spatula	4" x 3/4"	Each	TKPS-4	24/288	TWPS-4	24/288
Bakery Spatula	7-15/16" x 1-1/4"	Each	TKPS-7	12/144	TWPS-7	12/144
Bakery Spatula	10" x 1-3/8"	Each	TKPS-9	12/144	TWPS-9	12/72

\*Measurement reflects blade size not including offset



**Allergen Free**  
 SEE PAGE 253 FOR ALLERGEN-FREE PURPLE HANDLES

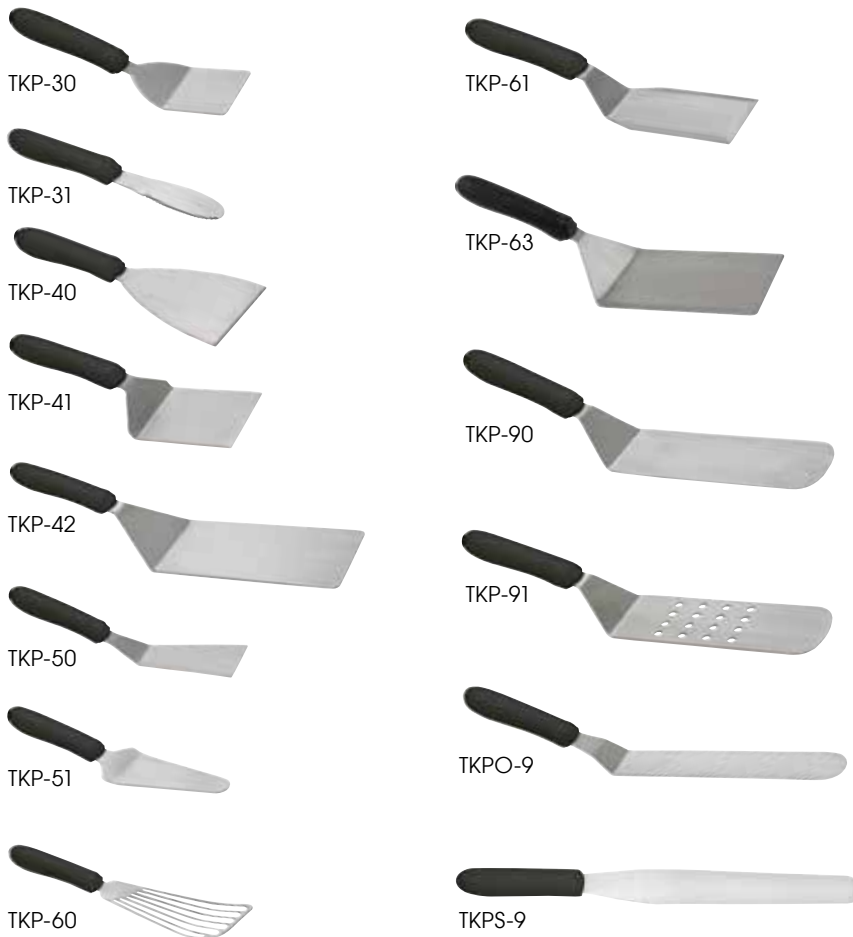

## PIZZA KNIVES & CUTTERS



**NSF** KPP-18



**NSF** KPP-20



PWC-4



PPC-4



VP-316



PPC-4W

**NSF** PPC & VP-SERIES

### PIZZA KNIVES

◆ NSF listed

ITEM	DESCRIPTION	UOM	CASE
KPP-18	18" Pizza Knife	Each	6/24
KPP-20	20" Pizza Rocker Knife	Each	6/24

### PIZZA CUTTERS

◆ NSF listed (plastic handles)

ITEM	DESCRIPTION	BLADE	UOM	CASE
PWC-4	Wooden Handle	4" Dia	Each	12/72
PPC-2	Black PP Handle, NSF	2-1/2" Dia	Each	12/72
PPC-4	Black PP Handle, NSF	4" Dia	Each	12/72
PPC-2W	White Handle, NSF	2-1/2" Dia	Each	12/72
PPC-4W	White Handle, NSF	4" Dia	Each	12/72
VP-315	Soft Grip Handle, NSF	2-1/2" Dia	Each	12/72
VP-316	Soft Grip Handle, NSF	4" Dia	Each	12/72

## CHOPPING KNIVES



KCC-3



KCC-4



**NSF** KCC-1



**NSF** KCC-2



### MEZZALUNA KNIVES

*Effortlessly chop herbs, greens, and large vegetables. The ergonomic design with its crescent-shaped blade is the perfect prepping tool for the kitchen.*

- ◆ Rock the blade side-to-side to chop tender herbs and greens
- ◆ Use an up-and-down motion to chop larger, dense vegetables
- ◆ Ergonomic design allows you to chop effortlessly
- ◆ Durable 18/8 stainless steel

ITEM	DESCRIPTION	UOM	CASE
KCC-3	Single Blade	Each	12/72
KCC-4	Double Blade	Each	12/72



### CHOPPING KNIVES

- ◆ Use flat blade on cutting boards to chop and mince food
- ◆ Use rounded edges inside mixing bowls to cut and fold ingredients
- ◆ Dishwasher safe
- ◆ NSF listed

ITEM	DESCRIPTION	UOM	CASE
KCC-1	Single Blade	Each	6/72
KCC-2	Double Blade	Each	6/48

## OYSTER/CLAM KNIVES



**NSF** VP-314



**NSF** KCL-5P



KCL-1



KCL-2



KCL-3

### OYSTER/CLAM KNIVES

ITEM	DESCRIPTION	SIZE	UOM	CASE
VP-314	2-7/8" Blade, Soft Rubber Grip NSF	7-5/8" O.L.	Each	12/72
KCL-5P	3" Blade, Plastic Handle, NSF	6-3/4" O.L.	Each	12/72
KCL-1	2-3/4" Blade, Wooden Handle	5-7/8" O.L.	Each	12/72
KCL-2	2-7/8" Blade, Wooden Handle	6-5/8" O.L.	Each	12/72
KCL-3	3-1/2" Blade, Wooden Handle	7-1/2" O.L.	Each	12/72

**DOUBLE HANDLE CHEESE KNIFE**

- ◆ NSF listed

ITEM	DESCRIPTION	UOM	CASE
KCP-15	15"L, Double PP Handles	Each	6/24

**CHEESE CUTLERY**



KCP-15 NSF

**WIRE CHEESE SLICERS**

- ◆ Provides a smoother cut than cheese knives
- ◆ Wire is 44" long 18/8 stainless steel
- ◆ Customized control over slicing thickness and angle
- ◆ Easy cleanup

ITEM	DESCRIPTION	UOM	CASE
CS-44P	Polyethylene Handles	Each	24/144
CS-44W	Wooden Handles	Each	24/144



CS-44P

CS-44W

**CAST ALUMINUM CHEESE SLICER**

ITEM	DESCRIPTION	UOM	CASE
ACS-4	5" Wide Blade, S/S Wire	Each	12/36



ACS-4

**CHEESE PLANE**

- ◆ Comfortable non-slip soft-grip handle
- ◆ Dishwasher safe
- ◆ NSF listed

ITEM	DESCRIPTION	UOM	CASE
VP-309	Stainless Steel	Each	12/72



VP-309 NSF

**ERGONOMIC HANDLE CHEESE GRATERS**

- ◆ Extra strength wire frame resists bending
- ◆ Comfortable non-slip soft-grip handle
- ◆ Dishwasher safe
- ◆ NSF listed

ITEM	DESCRIPTION	UOM	CASE
VP-311	Small Holes, 1.5mm Dia	Each	12/72
VP-312	Medium Holes, 3mm Dia	Each	12/72
VP-313	Large Holes, 6mm Dia	Each	12/72



VP-311

VP-312

VP-313

VP-SERIES NSF

**STAINLESS STEEL CHEESE GRATER**

- ◆ 18/8 stainless steel rotary grater with one drum for grating fine cheeses

ITEM	DESCRIPTION	UOM	CASE
GRTS-1	8-1/4"L x 4-3/4"W x 3-3/8"H	Each	12/36



GRTS-1

**PLASTIC CHEESE GRATER**

ITEM	DESCRIPTION	UOM	CASE
PRTS-2	Cheese Grater	Each	6/24



PRTS-2

**CHEESE KNIFE SETS**

Whether it's for a wine tasting event or to accompany dessert, elegantly present and serve a full range of cheeses with these 6-piece cheese knife sets.

- ◆ Each set includes six (6) knives for hard, soft, firm, crumbly cheeses
- ◆ Stainless steel blades

ITEM	DESCRIPTION	UOM	CASE
KCS-6	6-Pc Set w/POM Hdls	Set	1/48
KCS-6W	6-Pc Set w/Wooden Hdls	Set	1/48



KCS-6



KCS-6W



STEAK KNIVES



ACERO STEAK KNIVES

With its sharp serrated edge and pointed tip, the Acero knife is designed to make simple work of cutting through steaks and chops. A stainless steel end cap provides excellent balance and control. This heavy-weight knife is a Winco exclusive and is a must-have on the tables of any steak house.



ITEM	DESCRIPTION	BLADE	UOM	CASE
SK-1	Acero Gourmet Steak Knives, 4-pc Gift Pack	5"	Pack	1/6
SK-12	Acero Gourmet Steak Knives, 12-pc Bulk Pack	5"	Doz	1/6
SK-22	Acero Gourmet Steak Knives, Round Tip	5"	Doz	1/6



SK-SERIES



SK-1 & 12



SK-22



KB-30W



KB-15W



K-438W



K-55W



K-45W



K-35W



K-80P



K-85P



K-60P



K-50P



WOODEN HANDLE KNIVES

ITEM	DESCRIPTION	BLADE	UOM	CASE
KB-30W	Jumbo Steak Knives, Pointed Tip	5"	Doz	1/12
KB-15W	Jumbo Steak Knives, Round Tip	5"	Doz	1/12
K-438W	Steak Knives, Pointed Tip and Handle	4-3/8"	Doz	1/24
K-55W	Steak Knives, Rounded Tip	4-1/2"	Doz	1/48
K-45W	Steak Knives, Pointed Tip	4-1/2"	Doz	1/48
K-35W	Economy Steak Knives, Pointed Tip	4"	Doz	1/48

PLASTIC HANDLE KNIVES

ITEM	DESCRIPTION	BLADE	UOM	CASE
K-80P	Jumbo Steak Knives, Round Tip, 3 Rivets	5"	Doz	1/25
K-85P	Jumbo Steak Knives, Round Tip, 2 Rivets, NSF	5"	Doz	1/12
K-60P	Steak Knives, Pointed Tip, NSF	5"	Doz	1/24
K-50P	Steak Knives, Round Tip, NSF	5"	Doz	1/48

INDUCTION-READY

# TRI=GEN™

by **winco**®



## NEXT GENERATION COOKWARE



Fry Pans  
Sauté Pans  
Sauce Pans  
Stock Pots  
Braziers



TRI=GEN™  
COOKWARE



**EXCALIBUR**  
Non-stick finish

Excalibur non-stick finish is reinforced externally with a proprietary stainless-steel alloy  
**Highest performing commercial coating available**

**TRI-PLY INDUCTION-READY FRY PANS**

- ◆ Handles offer excellent comfort and pan control, minimizing hand fatigue for high-volume operators
- ◆ Triangular positioned rivets provide strength - will not loosen in high-volume commercial kitchens
- ◆ Available in natural and Excalibur® non-stick finishes
- ◆ Five (5) sizes available
- ◆ NSF listed

7"



ITEM	DESCRIPTION	SIZE	UOM	CASE
TGFP-7	Natural Finish	7"	Each	1/6
TGFP-7NS	Non-stick	7"	Each	1/6
TGFP-8	Natural Finish	8"	Each	1/6
TGFP-8NS	Non-stick	8"	Each	1/6
TGFP-10	Natural Finish	10"	Each	1/6
TGFP-10NS	Non-stick	10"	Each	1/6
TGFP-12	Natural Finish	12"	Each	1/2
TGFP-12NS	Non-stick	12"	Each	1/2
TGFP-14	Natural Finish	14"	Each	1/2
TGFP-14NS	Non-stick	14"	Each	1/2

8"



12"



10"



14"

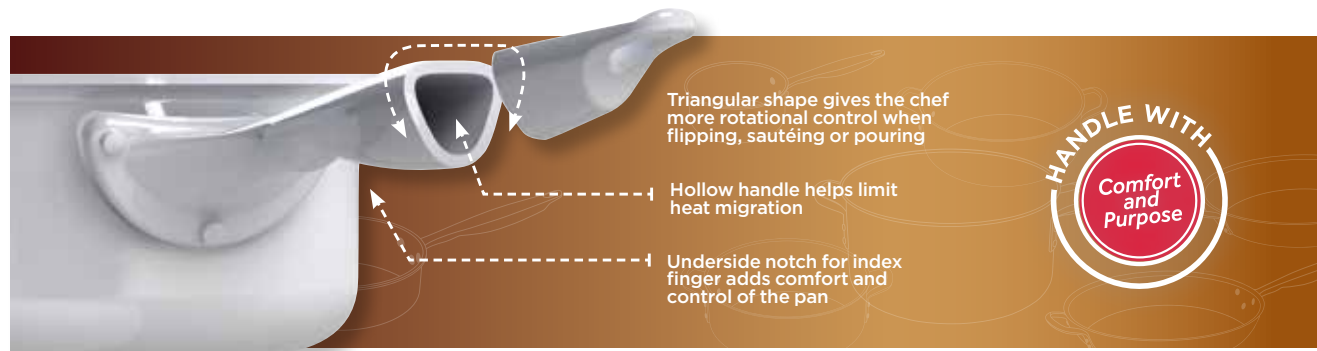

**TRI-PLY INDUCTION-READY SAUCE PANS**

- ◆ Perfect for preparing many dishes with style and comfort
- ◆ Triangular positioned rivets provide strength - will not loosen in high-volume commercial kitchens
- ◆ Mirror finish exterior; satin finish interior
- ◆ Five (5) sizes available
- ◆ NSF listed

ITEM	DESCRIPTION	SIZE	DIA	UOM	CASE
TGAP-2	Sauce Pan w/ Cover	1.5 Qt	6"	Set	1/6
TGAP-3	Sauce Pan w/ Cover	2.5 Qt	7"	Set	1/6
TGAP-4	Sauce Pan w/ Cover	3.5 Qt	8"	Set	1/4
TGAP-5	Sauce Pan w/ Cover	4.5 Qt	8.5"	Set	1/4
TGAP-7	Sauce Pan w/ Cover, Helper Hdl	7 Qt	9.5"	Set	1/2

Handles built for comfort and purpose.



**NEW**

TGAP-5  
17-3/8"L x 9-1/4"W  
including handle  
5-1/8"H pan only



**NEW**

TGAP-2  
14-1/2"L x 7"W  
including handle  
3-5/8"H pan only



**NEW**

TGAP-3  
15-1/8" x 7-3/4"  
including handle  
4-1/8" pan only



**NEW**

TGAP-7  
19-7/8"L x 10"W  
including handles  
6-1/2"H pan only



**NEW**

TGAP-4  
16-5/8" x 8-1/2"  
including handle  
4-3/4" pan only

TGAP-SERIES



Visually  
stunning

---

Highly  
functional

 **TRI-PLY INDUCTION-READY SAUTÉ PANS**

- ◆ Deep, straight sides for easy stirring, mixing or flipping of food without spilling
- ◆ Sauté, brown or stir-fry with ease
- ◆ Mirror finish exterior; satin finish interior
- ◆ Four (4) sizes available
- ◆ NSF listed

ITEM	DESCRIPTION	SIZE	DIA	UOM	CASE
TGET-2	Sauté Pan w/ Cover	2 Qt	8"	Set	1/6
TGET-3	Sauté Pan w/ Cover	3 Qt	9.5"	Set	1/6
TGET-6	Sauté Pan w/ Cover, Helper Hdl	6 Qt	12.5"	Set	1/4
TGET-7	Sauté Pan w/ Cover, Helper Hdl	7 Qt	14"	Set	1/2

2qt



TGET-2

16-5/8"L x 8-1/2"W  
including handle  
3-1/4"H pan only

6qt



TGET-6

24-1/4"L x 13-1/8"W  
including handles  
4-1/8"H pan only

3qt



TGET-3

18-1/8"L x 10"W  
including handle  
3-5/8"H pan only

7qt



TGET-7

26-1/8"L x 15"W  
including handles  
4"H pan only



TGET-SERIES



Triangular shaped handle with outward sloping top provides the chef with better control and a more comfortable thumb rest.

Compatible with  
Induction, Gas & Electric



**TRI-PLY INDUCTION-READY STOCK POTS**

- ◆ Larger sizes for higher volume food preparation
- ◆ Securely riveted wide loop handles provide excellent stability, especially for larger hands when handling with hot pads
- ◆ Mirror finish exterior; satin finish interior
- ◆ Six (6) sizes available
- ◆ NSF listed

ITEM	DESCRIPTION	SIZE	DIA	UOM	CASE
TGSP-4	Stock Pot w/Cover	4.5 Qt	8.5"	Set	1/6
TGSP-6	Stock Pot w/Cover	6 Qt	8.5"	Set	1/6
TGSP-8	Stock Pot w/Cover	8 Qt	9.5"	Set	1/6
TGSP-12	Stock Pot w/Cover	12 Qt	12"	Set	1/4
TGSP-16	Stock Pot w/Cover	16 Qt	12.5"	Set	1/4
TGSP-20	Stock Pot w/Cover	20 Qt	14"	Set	1/4



Strength  
& Balance

12qt



TGSP-12

16-1/2"W including handles  
7-1/4"H pot only

4.5qt



TGSP-4

13"W including handles  
5-1/4"H pot only

16qt



TGSP-16

17-1/4"W including handles  
8-1/4"H pot only

6qt



TGSP-6

13"W including handles  
6-5/8"H pot only

20qt



TGSP-20

19"W including handles  
8-1/4"H pot only

8qt



TGSP-8

13-3/4"W including handles  
7-3/8"H pot only

TGSP-SERIES



-  Induction
-  Gas
-  Electric

 **TRI-PLY INDUCTION-READY BRAZIER**

- ◆ Larger sizes for higher volume food preparation
- ◆ Securely riveted wide loop handles provide excellent stability, especially for larger hands when handling with hot pads
- ◆ Mirror finish exterior; satin finish interior
- ◆ Two (2) sizes available
- ◆ NSF listed

ITEM	DESCRIPTION	SIZE	DIA	UOM	CASE
TGBZ-12	Brazier w/Cover	12 Qt	13.5"	Set	1/4
TGBZ-14	Brazier w/Cover	14 Qt	14"	Set	1/4

12qt



TGBZ-12

18"W including handles  
5-1/2"H brazier only

14qt



TGBZ-14

19"W including handles  
6"H brazier only



TGBZ-SERIES

Packaging





SST-32



SST-10



SSSP-6



SSLB-15

SEE PAGE 332  
FOR INDUCTION  
COOK-TOPS



SSET-5

## PREMIUM STAINLESS STEEL COOKWARE

- ◆ Commercial-quality premium stainless steel
- ◆ Tri-ply heavy-duty bottom for even heat distribution
- ◆ Extra sturdy 6-point welding on handles
- ◆ Induction ready
- ◆ NSF listed



PREMIUM STAINLESS  
STEEL COOKWARE



### STOCK POTS WITH COVER INCLUDED

ITEM	DESCRIPTION	SIZE (DIA X HEIGHT)	UOM	CASE
SST-8	8 Qt	9-1/2" x 6-3/4"	Set	1/4
SST-12	12 Qt	11" x 7-1/8"	Set	1/4
SST-16	16 Qt	11" x 9-3/4"	Set	1/4
SST-20	20 Qt	11-3/4" x 10-1/4"	Set	1/4
SST-24	24 Qt	13-3/8" x 10-1/4"	Set	1/2
SST-32	32 Qt	14-1/4" x 11-3/4"	Set	1/2
SST-40	40 Qt	15-3/4" x 11-3/4"	Set	1/2
SST-60	60 Qt	17-3/4" x 14-1/4"	Set	1
SST-80	80 Qt	19-3/4" x 15-3/4"	Set	1

### REPLACEMENT COVERS

ITEM	UOM	CASE
SSTC-8	Each	6/12
SSTC-12	Each	6/12
SSTC-12	Each	6/12
SSTC-20	Each	6/12
SSTC-24	Each	6
SSTC-32	Each	6
SSTC-40	Each	6
SSTC-60	Each	6
SSTC-80	Each	6



### SAUCE PANS WITH COVER INCLUDED

ITEM	DESCRIPTION	SIZE (DIA X HEIGHT)	UOM	CASE
SSSP-2	2 Qt	6-3/8" x 3-3/4"	Set	1/6
SSSP-3	3 -1/2 Qt	8" x 4-1/4"	Set	1/6
SSSP-4	4 -1/2 Qt	8" x 5-1/2"	Set	1/6
SSSP-6	6 Qt	9-1/2" x 5"	Set	1/6
SSSP-7	7 -1/2 Qt w/Hdl	9-1/2" x 6-1/8"	Set	1/2
SSSP-10	10 Qt w/Hdl	11" x 6-1/8"	Set	1/2

### REPLACEMENT COVERS

ITEM	UOM	CASE
SSTC-2	Each	6
SSTC-8F	Each	6/12
SSTC-8F	Each	6/12
SSTC-8	Each	6/12
SSTC-8	Each	6/12
SSTC-12	Each	6/12



### BRAZIERIS WITH COVER INCLUDED

ITEM	DESCRIPTION	SIZE (DIA X HEIGHT)	UOM	CASE
SSLB-8	8 Qt	11" x 5-1/8"	Set	1/4
SSLB-10	10 Qt	11-11/16" x 5-1/2"	Set	1/4
SSLB-15	15 Qt	14-1/4" x 5-1/2"	Set	1/4
SSLB-20	20 Qt	15-3/4" x 6"	Set	1/4
SSLB-25	25 Qt	17-3/4" x 6"	Set	1/2
SSLB-30	30 Qt	19-3/4" x 6"	Set	1/2

### REPLACEMENT COVERS

ITEM	UOM	CASE
SSTC-12	Each	6/12
SSTC-20	Each	6/12
SSTC-32	Each	6
SSTC-40	Each	6
SSTC-60	Each	6
SSTC-80	Each	6



### SAUTÉ PANS WITH COVER INCLUDED

ITEM	DESCRIPTION	SIZE (DIA X HEIGHT)	UOM	CASE
SSET-3	3 Qt	10" x 2-3/4"	Set	1/6
SSET-5	5 Qt	12-3/8" x 3-1/8"	Set	1/4
SSET-7	7 Qt	14" x 3-1/2"	Set	1/4

### REPLACEMENT COVERS

ITEM	UOM	CASE
SSTC-8	Each	6/12
SSTC-20	Each	6/12
SSTC-24	Each	6





## PREMIUM STAINLESS STEEL OMELET PANS



SSOP-9



SSOP-14



SSOP-SERIES



### OMELET PANS

ITEM	DESCRIPTION	SIZE (DIA X H)	UOM	CASE
SSOP-8	8"	8" x 1-3/4"	Each	1/6
SSOP-9	9-1/2"	9-1/2" x 2"	Each	1/6
SSOP-11	11"	11" x 2-1/8"	Each	1/6
SSOP-12	12-1/2"	12-1/2" x 2-1/4"	Each	1/2
SSOP-14	14"	14" x 2-1/4"	Each	1/2

## PREMIUM STAINLESS STEEL FRY PANS



SSFP-11



SSFP-14

SEE PAGE 332 FOR INDUCTION COOKTOP



SSFP-11NS



SSFP-14NS



SSFP-SERIES



NON-STICK FRY PANS



- ◆ Heavy-duty commercial quality premium stainless steel
- ◆ Tri-ply heavy-duty bottom for even heat distribution
- ◆ Extra sturdy riveted 6-point welding on handles

### FRY PANS

- ◆ Induction ready
- ◆ NSF listed

ITEM	DESCRIPTION	SIZE	UOM	CASE
SSFP-8	8"	8" x 1-1/2"	Each	1/6
SSFP-9	9-1/2"	9-1/2" x 1-3/4"	Each	1/6
SSFP-11	11"	11" x 2"	Each	1/6
SSFP-12	12", Help Hdl	12-1/2" x 2"	Each	1/2
SSFP-14	14", Help Hdl	14-1/4" x 2-1/2"	Each	1/2



### NON-STICK FRY PANS

- ◆ Excalibur® non-stick coating
- ◆ Induction ready
- ◆ NSF listed

ITEM	DESCRIPTION	SIZE	UOM	CASE
SSFP-8NS	8"	8" x 1-1/2"	Each	1/6
SSFP-9NS	9-1/2"	9-1/2" x 1-3/4"	Each	1/6
SSFP-11NS	11"	11" x 2"	Each	1/6
SSFP-12NS	12", Help Hdl	12-1/2" x 2"	Each	1/2
SSFP-14NS	14", Help Hdl	14-1/4" x 2-1/2"	Each	2

### COVERS FOR STAINLESS STEEL FRY PANS

ITEM	DESCRIPTION	UOM	CASE
SSTC-8F	Cover for 8" Fry Pans	Each	6/12
SSTC-8	Cover for 9-1/2" Fry Pans	Each	6/12
SSTC-12	Cover for 10" and 11" Fry Pans	Each	6/12
SSTC-12F	Cover for 12" Fry Pans	Each	6/12
SSTC-32	Cover for 14" Fry Pans	Each	6

## MIRROR SAUCE PANS



SAP-2

### MIRROR FINISH SAUCE PANS

- ◆ Triple riveted handle

ITEM	DESCRIPTION	UOM	CASE
SAP-1.5	1 -1/2 Qt	Each	12/36
SAP-2	2 Qt	Each	12/36

## DOUBLE POT HOOK



PH-2

### DOUBLE POT HOOK

ITEM	DESCRIPTION	UOM	CASE
PH-2	Pot Hook	Each	24/240

**PREMIUM STAINLESS STEEL COOKWARE SET**

- ◆ Induction ready
- ◆ Extra heavy-weight stainless steel with double riveted handles
- ◆ Aluminum core, best for fast and even distribution of heat, is impact bonded between two layers of stainless steel, ensuring a lifetime of use
- ◆ 7-pc set consists of 1 quart covered sauce pan, 2 quart covered sauce pan, 5 quart covered dutch oven, and 9-1/2" saute pan

ITEM	DESCRIPTION	UOM	CASE
SPC-7H	7-Pc Set	Set	1/2



SEE PAGE 332 FOR INDUCTION COOKTOP



SPC-7H INDUCTION READY

**DOUBLE BOILERS & PERFORATED STEAMERS**

- ◆ Induction ready
- ◆ Cover included
- ◆ Stainless steel
- ◆ Tri-ply bottom

ITEM	DESCRIPTION	SIZE	UOM	CASE
SSDB-8	8 Qt Double Boiler	9-1/2" x 6-3/4" & 7-1/2"	Set	1/6
SSDB-12	12 Qt Double Boiler	10-1/4" x 8-1/2" & 9-3/8"	Set	1/6
SSDB-16	16 Qt Double Boiler	11" x 9-5/8" & 10-1/2"	Set	1/4
SSDB-20	20 Qt Double Boiler	11-7/8" x 10-5/8" & 11-1/2"	Set	1/4
SSDB-8S	8 Qt Steamer/Pasta Cooker	9-1/2" x 6-3/4" & 7-1/2"	Set	1/6
SSDB-12S	12 Qt Steamer/Pasta Cooker	10-1/4" x 8-1/2" & 9-3/8"	Set	1/6
SSDB-16S	16 Qt Steamer/Pasta Cooker	11" x 9-5/8" & 10-1/2"	Set	1/4
SSDB-20S	20 Qt Steamer/Pasta Cooker	11-7/8" x 10-5/8" & 11-1/2"	Set	1/4

**REPLACEMENT LIDS**

ITEM	DESCRIPTION	SIZE	UOM	CASE
SSTC-8	Replacement Cover for 8 Qt		Each	6/12
SSTC-10	Replacement Cover for 12 Qt		Each	6
SSTC-12	Replacement Cover for 16 Qt		Each	6/12
SSTC-20	Replacement Cover for 20 Qt		Each	6/12

**DOUBLE BOILERS & PERFORATED STEAMERS**



SSDB-20  
SSDB-20S  
SSDB-SERIES  
SSTC-SERIES INDUCTION READY

**EGG POACHER SET**

*When a meal calls for perfectly poached eggs, this 4-cup set gets the job done quickly. The glass lid provides easy monitoring without the loss of heat so eggs cook uniformly.*

- ◆ Also can be used as mini-double boilers for melting butter or chocolate or steaming individual custard portions
- ◆ Set includes stainless steel sauce pan, glass cover, tray and 4 cups with cool touch handles
- ◆ Pan interior, tray and cups feature non-stick coating for easy release and cleaning
- ◆ Suitable for all stove tops, including induction
- ◆ Dishwasher safe

ITEM	DESCRIPTION	UOM	CASE
CEP-4	4-Cup Set	Set	1/6

**EGG POACHER SET**



CEP-4 INDUCTION READY

## SPECIALTY PANS



CSFP-11



CSFP-SERIES

MADE IN SPAIN



CSPP-11

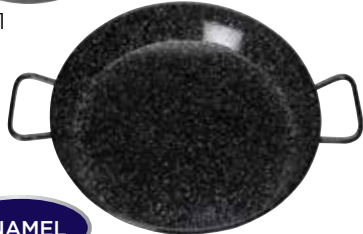

ENAMEL

CSPP-14E



CSPP-35



## FRENCH-STYLE FRY PANS

The Spanish-made, French-style fry pan is ideal for high-heat cooking. Well suited for long pre-heating and searing.

- ◆ High-quality carbon steel pan allows for long pre-heating at high temperatures; suitable for searing
- ◆ Riveted handle
- ◆ Made in Spain

ITEM	DESCRIPTION	UOM	CASE
CSFP-7	7-7/8"	Each	5
CSFP-8	8-5/8"	Each	8
CSFP-9	9-1/2"	Each	7
CSFP-11	10-3/8"	Each	4
CSFP-12	11-1/8"	Each	3

\*Replaces former FSFP-Series



## PAELLA PANS

These Spanish-made carbon steel pans are ideal for the creation and display of authentic paella dishes, roasting meat, making stir-fry, and much more!

ITEM	DESCRIPTION	FINISH	UOM	CASE
CSPP-7	7-7/8"	Polished	Each	12
CSPP-11	11"	Polished	Each	10
CSPP-14	14-1/8"	Polished	Each	5
CSPP-23	23-5/8"	Polished	Each	1
CSPP-35	35-1/2", 4 Hdl	Polished	Each	1
CSPP-11E	11"	Enameled	Each	10
CSPP-14E	14-1/8"	Enameled	Each	5
CSPP-23E	23-5/8"	Enameled	Each	1



## WOKS & ACCESSORIES



WOK-16W



WOK-16N Joint



WOK-36



WKCS-14



WKR-8

### CHINESE WOKS

- ◆ Stainless steel mirror finish

ITEM	DESCRIPTION	UOM	CASE
WOK-14N	14", Riveted Joint	Each	12
WOK-16N	16", Riveted Joint	Each	12
WOK-14W	14", Welded Hdl	Each	12
WOK-16W	16", Welded Hdl	Each	12

### BLACK CARBON STEEL WOKS

- ◆ Japanese style
- ◆ Integrated handle with welded joint for enhanced strength
- ◆ 1.2 mm thickness

ITEM	DESCRIPTION	UOM	CASE
WOK-34	14"	Each	12
WOK-36	16"	Each	12

### WOK COVERS

- ◆ Stainless steel

ITEM	DESCRIPTION	UOM	CASE
WKCS-14	13-3/4"	Each	12/60
WKCS-15	15-3/8"	Each	12/48
WKCS-18	17-3/4"	Each	12/36

### WOK RING STAND

- ◆ Stainless steel

ITEM	DESCRIPTION	UOM	CASE
WKR-8	8"	Each	12/120

**FIREIRON™ CAST IRON SKILLETS**

Designed to last for generations, FireIron™ cast iron pans are pre-seasoned and induction ready. Great for kitchen-to-table service.

- ◆ Fine, smooth surface for excellent sear; also sauté, fry, boil, braise, bake and roast
- ◆ Widened handle with thumbrest for comfortable grip and better handling
- ◆ Induction ready; multiple cooking surfaces compatible

ITEM	DESCRIPTION	UOM	CASE
CAST-6	6"	Each	6
CAST-8	8"	Each	6
CAST-10	10"	Each	4
CAST-12	12"	Each	4

\*Replaces former RSK-Series



**CAST IRON PANS**



**ROUND CAST IRON GRILL PAN**

ITEM	DESCRIPTION	UOM	CASE
IGL-10	10", Black Coating	Each	8

**FAJITA SERVERS**

- ◆ Improved plywood underliner resists splitting, chipping or cracking under high-heat cast iron pan

ITEM	DESCRIPTION	UOM	CASE
FS-2	Fajita Server, 2-pc Set	Set	1/12
FS-2-UL	Replacement Underliner for FS-2	Each	12
ISP-3	Steak Platter with Gripper, 3-Pc Set	Set	1/12
ISP-3-UL	Replacement Underliner for ISP-3	Each	12



**DELUXE HARD-ANODIZED ALUMINUM GRIDDLE**

- ◆ Great for use on all kinds of ranges
- ◆ Griddle sits right on top of range for making pancakes, bacon or scrambled eggs
- ◆ Lifted handles are silicone wrapped, preventing heat transfer

ITEM	DESCRIPTION	UOM	CASE
HAG-2012	19-5/8"L x 12-1/4"W	Each	1/6

**CAST IRON GRIDDLE**

- ◆ Reversible, flat griddle on one side, raised grill surface on the other
- ◆ Black coating

ITEM	DESCRIPTION	UOM	CASE
IGD-2095	20"L x 9-1/2"W	Each	4

**CAST-IRON GRIDDLES**



**SKILLET/PAN HANDLE SLEEVES**

- ◆ Heat-resistant up to 250°F (120°C)

ITEM	DESCRIPTION	SIZE	UOM	CASE
HDH-7S	Cotton Sleeve	3-1/2" x 6-1/2"	Doz	1/24
HDH-6C	Chili Peppers Cotton Sleeve	3-1/2" x 6-1/2"	Doz	1/24

**PAN HANDLE SLEEVES**





## INDUCTION READY ALUMINUM COOKWARE



Induction ready pot/pan base



AFPI-10H



AFPI-SERIES



NON-STICK FRY PANS



New hybrid technology bonds a stainless steel plate to aluminum cookware, as effective in utilizing induction technology as full stainless steel cookware.

- ◆ Deep drawn 3003 Aluminum body is durable and highly conductive, better than stainless steel cookware for quickly and evenly distributing heat
- ◆ Stainless steel bonded plate allows for magnetic contact with induction cooktops
- ◆ Thicker handles and heavier rivets than standard cookware allow for secure comfort in transporting cookware
- ◆ Can also be safely used with gas or electric ranges
- ◆ NSF listed



### NATURAL FINISH INDUCTION READY ALUMINUM FRY PANS

- ◆ Ergonomic comfort handle is heat resistant to 500°F (260°C)

ITEM	DESCRIPTION	PLATE SIZE	UOM	CASE
AFPI-8H*	8"Dia	5"	Each	6
AFPI-10H	10"Dia	6-1/4"	Each	6
AFPI-12H	12"Dia	6-7/8"	Each	6

\*Compatible with all Winco® induction cookers. (May not be compatible with all induction cookers on the market.)



### NON-STICK FINISH INDUCTION READY ALUMINUM FRY PANS

- ◆ Quantum2® non-stick finish bonds to the aluminum for a long lasting, scratch-resistant finish
- ◆ Ergonomic comfort handle is heat resistant to 500°F (260°C)
- ◆ PFOA-free

ITEM	DESCRIPTION	PLATE SIZE	UOM	CASE
AFPI-8NH*	8"Dia	5"	Each	6
AFPI-10NH	10"Dia	6-1/4"	Each	6
AFPI-12NH	12"Dia	6-7/8"	Each	6

\*Compatible with all Winco® induction cookers. (May not be compatible with all induction cookers on the market.)



### INDUCTION READY STOCK POTS

- ◆ Reinforced rim adds extra durability, extending the integrity of the cookware
- ◆ 3003 Aluminum, 4.0mm, 3/16" thick

ITEM	DESCRIPTION	PLATE SIZE	UOM	CASE
AXSI-8	8 Qt	7-1/2"	Each	1
AXSI-10	10 Qt	7-1/2"	Each	1
AXSI-12	12 Qt	7-1/2"	Each	1
AXSI-16	16 Qt	7-1/2"	Each	1



### INDUCTION READY SAUTÉ PAN

- ◆ Thicker handle and heavier rivets than standard cookware allow for secure comfort when lifting and carrying
- ◆ 3003 Aluminum, 4.0mm, 3/16" thick

ITEM	DESCRIPTION	PLATE SIZE	UOM	CASE
AXTI-3	3 Qt	7-1/2"	Each	1/6

SEE PAGE 332 FOR INDUCTION COOKTOP



AXSI-16



AXSI-SERIES



AXTI-3



## COVERS FOR ALUMINUM FRY PANS



AXS-20C



AXS-SERIES

### COVERS FOR ALUMINUM FRY PANS

ITEM	DESCRIPTION	UOM	CASE
ASP-2C	For 8" Fry Pan	Each	12
AXS-16C	For 10" Fry Pan	Each	6
AXS-20C	For 12" Fry Pan	Each	6
AXS-40C	For 14" Fry Pan	Each	6

Constructed of 3003 series aluminum alloy with riveted heavy weight handles, the Gladiator fry pans will keep up with the rigorous demands of a commercial kitchen, in addition to providing excellent heat distribution for searing, browning and frying.

- ◆ 3.5mm thickness
- ◆ NSF listed

### GLADIATOR™ NATURAL FINISH

ITEM	DESCRIPTION	UOM	CASE
AFP-7A	7"Dia	Each	6
AFP-8A	8"Dia	Each	6
AFP-10A	10"Dia	Each	6
AFP-12A	12"Dia	Each	6
AFP-14A	14"Dia	Each	6
AFP-7A-H	7"Dia with Sleeve	Each	6
AFP-8A-H	8"Dia with Sleeve	Each	6
AFP-10A-H	10"Dia with Sleeve	Each	6
AFP-12A-H	12"Dia with Sleeve	Each	6
AFP-14A-H	14"Dia with Sleeve	Each	6

### GLADIATOR™ EXCALIBUR

- ◆ Excalibur® non-stick finish bonds to the aluminum for a long lasting, scratch-resistant finish

ITEM	DESCRIPTION	UOM	CASE
AFP-7XC	7"Dia	Each	6
AFP-8XC	8"Dia	Each	6
AFP-10XC	10"Dia	Each	6
AFP-12XC	12"Dia	Each	6
AFP-14XC	14"Dia	Each	6
AFP-7XC-H	7"Dia with Sleeve	Each	6
AFP-8XC-H	8"Dia with Sleeve	Each	6
AFP-10XC-H	10"Dia with Sleeve	Each	6
AFP-12XC-H	12"Dia with Sleeve	Each	6
AFP-14XC-H	14"Dia with Sleeve	Each	6

- ◆ Made of 3003 aluminum alloy, the Majestic™ fry pans offer exceptional performance at a great value
- ◆ Available in three finishes: Majestic™ mirror, Majestic™ natural & Majestic™ Quantum2®
- ◆ 3.5mm thickness
- ◆ NSF listed

### NATURAL FINISH ALUMINUM FRY PANS

ITEM	DESCRIPTION	UOM	CASE
AFP-7S	7"Dia	Each	6
AFP-8S	8"Dia	Each	6
AFP-10S	10"Dia	Each	6
AFP-12S	12"Dia	Each	6
AFP-14S	14"Dia	Each	6

### MIRROR FINISH ALUMINUM FRY PANS

ITEM	DESCRIPTION	UOM	CASE
AFP-7	7"Dia	Each	6
AFP-8	8"Dia	Each	6
AFP-10	10"Dia	Each	6
AFP-12	12"Dia	Each	6
AFP-14	14"Dia	Each	6

### QUANTUM2® NON-STICK ALUMINUM FRY PANS

ITEM	DESCRIPTION	UOM	CASE
AFP-7NS	7"Dia	Each	6
AFP-8NS	8"Dia	Each	6
AFP-10NS	10"Dia	Each	6
AFP-12NS	12"Dia	Each	6
AFP-14NS	14"Dia	Each	6
AFP-7NS-H	7"Dia with Sleeve	Each	6
AFP-8NS-H	8"Dia with Sleeve	Each	6
AFP-10NS-H	10"Dia with Sleeve	Each	6
AFP-12NS-H	12"Dia with Sleeve	Each	6
AFP-14NS-H	14"Dia with Sleeve	Each	6

## GLADIATOR™ FRY PANS



AFP-10A

AFP-10A-H



AFP-10XC

AFP-10XC-H

AFP-SERIES NSF

NON-STICK FRY PANS PFOA FREE

## MAJESTIC™ FRY PANS



AFP-8S

AFP-10

SEE PAGE 181 FOR REMOVABLE SLEEVES

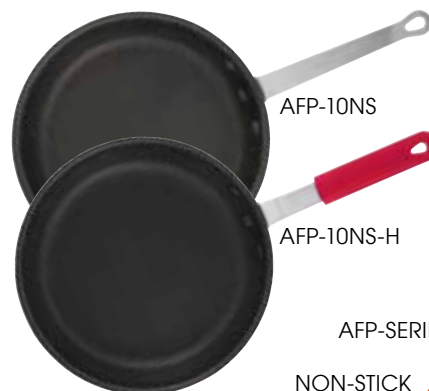

AFP-10NS

AFP-10NS-H

AFP-SERIES NSF

NON-STICK FRY PANS PFOA FREE

SEE PAGE 180 FOR EXTRA LARGE SIZES



AXHB-28



AXHA-60



AXHH-40



**SUPER ALUMINUM EXTRA-HEAVYWEIGHT COOKWARE**

- ◆ 6.0 mm, 1/4" thickness
- ◆ Best quality and prices in their class
- ◆ Extra thick reinforced rim and bottom to stand up to any amount of water and usage
- ◆ Deep-drawn structure for better strength and durability
- ◆ Thicker handles make lifting and carrying heavy pots easier
- ◆ Made of 3003 aluminum - excellent for fast and even heat distribution
- ◆ NSF listed

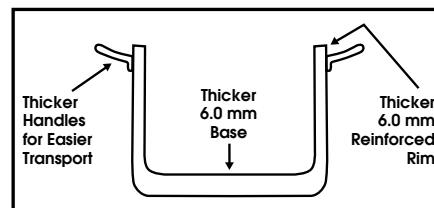

**EXTRA HEAVYWEIGHT ALUMINUM STOCK POTS**

ITEM	DESCRIPTION	SIZE (DIA X HEIGHT)	UOM	CASE
AXHH-12	12 Qt	10" x 9-1/4"	Each	1
AXHH-16	16 Qt	10" x 12"	Each	1
AXHH-20	20 Qt	12" x 10-1/2"	Each	1
AXHH-24	24 Qt	12" x 12-1/2"	Each	1
AXHH-32	32 Qt	13" x 14"	Each	1
AXHH-40	40 Qt	14" x 15"	Each	1
AXHH-60	60 Qt	16" x 17"	Each	1
AXHH-80	80 Qt	18" x 18-1/4"	Each	1

**COVERS**

ITEM	UOM	CASE
AXS-16C	Each	6
AXS-16C	Each	6
AXS-20C	Each	6
AXS-20C	Each	6
AXS-32C	Each	6
AXS-40C	Each	6
AXS-60C	Each	6
AXS-80C	Each	6

**EXTRA HEAVYWEIGHT ALUMINUM SAUCE POTS**

ITEM	DESCRIPTION	SIZE (DIA X HEIGHT)	UOM	CASE
AXHA-8	8 Qt	10" x 6-1/8"	Each	1
AXHA-14	14 Qt	12" x 7-3/4"	Each	1
AXHA-20	20 Qt	13" x 9-1/4"	Each	1
AXHA-26	26 Qt	14" x 10-1/4"	Each	1
AXHA-34	34 Qt	16" x 10-1/4"	Each	1
AXHA-40	40 Qt	16" x 11-3/4"	Each	1
AXHA-60	60 Qt	18" x 13-3/4"	Each	1

**COVERS**

ITEM	UOM	CASE
AXS-16C	Each	6
AXS-20C	Each	6
AXS-32C	Each	6
AXS-40C	Each	6
AXS-60C	Each	6
AXS-60C	Each	6
AXS-80C	Each	6

**EXTRA HEAVYWEIGHT ALUMINUM BRAZIER**

ITEM	DESCRIPTION	SIZE (DIA X HEIGHT)	UOM	CASE
AXHB-15	15 Qt	14" x 5-7/8"	Each	1
AXHB-18	18 Qt	16" x 5-13/32"	Each	1
AXHB-24	24 Qt	18" x 5-5/8"	Each	1
AXHB-28	28 Qt	18" x 6-7/16"	Each	1

**COVERS**

ITEM	UOM	CASE
AXS-40C	Each	6
AXS-60C	Each	6
AXS-80C	Each	6
AXS-80C	Each	6



**SUPER ALUMINUM STANDARD WEIGHT COOKWARE**

- ◆ **4.0 mm, 3/16" thickness**
- ◆ Best quality and prices in their class
- ◆ Extra thick reinforced rim and bottom to stand up to any amount of water and usage
- ◆ Deep-drawn structure for better strength and durability
- ◆ Thicker handles make lifting and carrying heavy pots easier
- ◆ Made of 3003 aluminum - excellent for fast and even heat distribution
- ◆ NSF listed

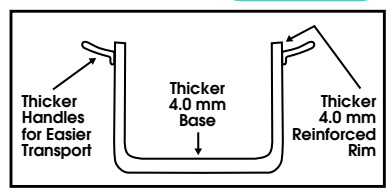

**HEAVYWEIGHT ALUMINUM STOCK POTS**

ITEM	DESCRIPTION	SIZE (DIA X HEIGHT)	UOM	CASE
AXS-8	8.5 Qt	10" x 6-1/2"	Each	1
AXS-10	10 Qt	10" x 7-1/2"	Each	1
AXS-12	12 Qt	10" x 9"	Each	1
AXS-16	16 Qt	10" x 12"	Each	1
AXS-20	20 Qt	12" x 10-1/2"	Each	1
AXS-24	24 Qt	12" x 12-1/4"	Each	1
AXS-32	32 Qt	13" x 14"	Each	1
AXS-40	40 Qt	14" x 15"	Each	1
AXS-50	50 Qt	16" x 14"	Each	1
AXS-60	60 Qt	16" x 17"	Each	1
AXS-80	80 Qt	18" x 18-1/4"	Each	1

**COVERS**

ITEM	UOM	CASE
AXS-16C	Each	6
AXS-16C	Each	6
AXS-16C	Each	6
AXS-16C	Each	6
AXS-20C	Each	6
AXS-20C	Each	6
AXS-32C	Each	6
AXS-40C	Each	6
AXS-60C	Each	6
AXS-60C	Each	6
AXS-80C	Each	6

**HEAVYWEIGHT ALUMINUM SAUCE POTS**

ITEM	DESCRIPTION	SIZE (DIA X HEIGHT)	UOM	CASE
AXAP-8	8 Qt	10" x 6"	Each	1
AXAP-14	14 Qt	12" x 7-1/2"	Each	1
AXAP-20	20 Qt	13" x 9"	Each	1
AXAP-26	26 Qt	14" x 10"	Each	1
AXAP-34	34 Qt	16" x 10"	Each	1
AXAP-40	40 Qt	16" x 11-1/2"	Each	1

**COVERS**

ITEM	UOM	CASE
AXS-16C	Each	6
AXS-20C	Each	6
AXS-32C	Each	6
AXS-40C	Each	6
AXS-60C	Each	6
AXS-60C	Each	6

**HEAVYWEIGHT ALUMINUM BRAZIER**

ITEM	DESCRIPTION	SIZE (DIA X HEIGHT)	UOM	CASE
AXBZ-15	15 Qt	14-3/8" x 5-3/4"	Each	1
AXBZ-18	18 Qt	16-3/8" x 5-1/2"	Each	1
AXBZ-24	24 Qt	18-3/8" x 5-3/4"	Each	1
AXBZ-28	28 Qt	18-3/8" x 6-1/2"	Each	1

**COVERS**

ITEM	UOM	CASE
AXS-40C	Each	6
AXS-60C	Each	6
AXS-80C	Each	6
AXS-80C	Each	6

**HEAVYWEIGHT ALUMINUM SAUTE PANS (NON-NSF)**

ITEM	DESCRIPTION	SIZE (DIA X HEIGHT)	UOM	CASE
AXST-3	3 Qt	10" x 2-1/2"	Each	6
AXST-5	5 Qt	12-1/2" x 2-1/2"	Each	6
AXST-7	7-1/2 Qt	14-1/2" x 2-3/4"	Each	6

**COVERS**

ITEM	UOM	CASE
AXS-16C	Each	6
AXS-20C	Each	6
AXS-40C	Each	6



## PRECISION ALUMINUM COOKWARE



ALHP-120



ALHP-120H



ALBH-35

**NSF** PRECISION ALUMINUM COOKWARE

- ◆ 6.0 mm, 1/4" thickness
- ◆ NSF listed, reinforced rim, superior strength and durability

### EXTRA HEAVYWEIGHT ALUMINUM STOCK POTS

ITEM	DESCRIPTION	SIZE (DIA X HEIGHT)	UOM	CASE
ALHP-100	100 Qt	20" x 17.7"	Each	1
ALHP-120	120 Qt	21.7" x 19.5"	Each	1
ALHP-140	140 Qt	22.8" x 20.3"	Each	1
ALHP-160	160 Qt	22.8" x 23.2"	Each	1
ALHP-120H	120 Qt, 4 Hdl	21.7" x 19.5"	Each	1
ALHP-140H	140 Qt, 4 Hdl	22.8" x 20.3"	Each	1
ALHP-160H	160 Qt, 4 Hdl	22.8" x 23.2"	Each	1

### EXTRA HEAVYWEIGHT ALUMINUM BRAZIER

ITEM	DESCRIPTION	SIZE (DIA X HEIGHT)	UOM	CASE
ALBH-35	35 Qt	21.7" x 6"	Each	1
ALBH-40	40 Qt	22.8" x 6"	Each	1

## WINWARE ALUMINUM COOKWARE



ALST-100



ALB-40

ASET-7



**NSF** WINWARE ALUMINUM COOKWARE

- ◆ 4.0 mm, 3/16" thickness
- ◆ NSF listed, reinforced rim, strong and durable

### WINWARE HEAVYWEIGHT ALUMINUM STOCK POT

ITEM	DESCRIPTION	SIZE (DIA X HEIGHT)	UOM	CASE
ALST-100	100 Qt	20" x 17.7"	Each	1

### HEAVYWEIGHT ALUMINUM BRAZIER

ITEM	DESCRIPTION	SIZE (DIA X HEIGHT)	UOM	CASE
ALB-35	35 Qt	21.7" x 6"	Each	1
ALB-40	40 Qt	22.8" x 6"	Each	1

### HEAVYWEIGHT ALUMINUM SAUTÉ PANS

ITEM	DESCRIPTION	SIZE (DIA X HEIGHT)	UOM	CASE
ASET-3	3 Qt	9.8" x 2.6"	Each	1
ASET-5	5 Qt	11.8" x 2.6"	Each	1
ASET-7	7.5 Qt	13.8" x 2.7"	Each	1

## ALUMINUM COVERS



AXS-40C

### COVERS

ITEM	DESCRIPTION	UOM	CASE
ALPC-100	Fits ALHP-100, ALST-100	Each	6
ALPC-120	Fits ALHP-120/120H, ALBH-35, ALB-35	Each	6
ALPC-140	Fits ALHP-140/140H/160/160H, ALBH-40, ALB-40	Each	6
AXS-16C	Fits ASET-3	Each	6
AXS-20C	Fits ASET-5	Each	6
AXS-40C	Fits ASET-7	Each	6

### DOUBLE ROASTER COMBINATION

◆ Heavy-duty 10 gauge aluminum

ITEM	DESCRIPTION	SIZE	UOM	CASE
ALRP-1824	Roaster with Straps	24"L x 18"W x 4-1/2"H	Each	2
ALRP-1824L	Roaster with Straps & Lugs	24"L x 18"W x 4-1/2"H	Each	2

### BAKE/ROAST PANS

◆ Heavy-duty 12 gauge aluminum

ITEM	DESCRIPTION	SIZE	UOM	CASE
ALRP-1826	Pan without Handles	25-3/4"L x 17-3/4"W x 2-1/4"H	Each	3
ALRP-1826H	Pan with Handles	25-3/4"L x 17-3/4"W x 3-1/2"H	Each	3

### BAKE/ROAST PAN

◆ Aluminum

ITEM	DESCRIPTION	SIZE	UOM	CASE
ALBP-1218	Pan with Handles	17-3/4"L x 11-1/2"W x 2-1/4"H	Each	6/24

### HEAVY-DUTY ALUMINUM SHEET PANS

*Reinforced with galvanized wire, count on Winco® sheet pans to hold their shape in high-heat oven temperatures during baking, roasting or broiling.*

- ◆ Closed bead with galvanized wire for rust resistance and reinforcement
- ◆ Made of 3003 aluminum

ITEM	DESCRIPTION	SIZE	GAUGE	UOM	CASE
ALXP-1200	Full-Size Open Bead, NSF	18" x 26"	12	Each	12
ALXP-2618H	Full-Size Closed Bead	18" x 26"	16	Each	12

## ALUMINUM ROASTING PANS

REINFORCED, IMPROVED FINISH



ALRP-1824



ALRP-1824L



ALRP-1826H



ALRP-1826



ALBP-1218



SEE PAGE 200 FOR OTHER SHEET PANS

ALXP-1200



Open bead

### PAN GRABBER

◆ Heat-resistant up to 400°F (205°C)

ITEM	DESCRIPTION	SIZE (L X W)	UOM	CASE
PH-811W	Terry Cloth	11" x 8"	Doz	15

### REMOVABLE SILICONE SLEEVES FOR FRY & SAUCE PANS

◆ Heat-resistant up to 450°F (230°C)

ITEM	DESCRIPTION	COLOR	UOM	CASE
AFP-1HR	Fits AFP-7, -8, ASP-1, -2	Red	Each	12/120
AFP-10HR	Fits AFP-10, ASFP-11, ASP-3, -4	Red	Each	12/120
AFP-2HR	Fits AFP-12, ASP-5, -7, AXST-3	Red	Each	12/120
AFP-3HR	Fits AFP-14, ASP-10, AXST-5, -7	Red	Each	12/120
AFP-1HX	Fits AFP-7, -8, ASP-1, -2	Blue	Each	12/120
AFP-2HX	Fits AFP-12, ASP-5, -7, AXST-3	Blue	Each	12/120
AFP-3HX	Fits AFP-14, ASP-10, AXST-5, -7	Blue	Each	12/120

### ALLERGEN-FREE SILICONE SLEEVE

ITEM	DESCRIPTION	COLOR	UOM	CASE
AFP-10HP	Fits AFP-10, ASFP-11, ASP-3, -4	Purple	Each	1/120

## COOKWARE ACCESSORIES



PH-811W



AFP-HR-SERIES



AFP-HX-SERIES

SEE PAGE 251 FOR MORE OF THE ALLERGEN-FREE LINE



AFP-10HP

## ALUMINUM GYRO PAN



Curved front



NSF AGP-10

## 10" ALUMINUM GYRO PAN

The perfect pan for catching meat that is carved off of a gyro cone when rotating on a vertical broiler.

- ◆ Ergonomically designed, insulated silicone handle is heat-resistant up to 450°F (230°C)
- ◆ NSF listed

ITEM	DESCRIPTION	UOM	CASE
AGP-10	10" Gyro Pan	Each	12

## HEAVY-DUTY STRAIGHT ALUMINUM SAUCE PANS

AVAILABLE IN FEBRUARY 2018



ASP-6SW

NSF ASP-SERIES

## ALUMINUM STRAIGHT-SIDED SAUCE PANS

- ◆ 3003 Aluminum, 4.0mm thickness
- ◆ Broad base offers widest area for optimal heating; ideal for cooking sauces or vegetables

ITEM	DESCRIPTION	SIZE (DIA X H)	UOM	CASE
ASP-2SW	2-1/2 Qt	7-1/2" x 3-5/16"	Each	1/12
ASP-4SW	4 Qt	7-1/2" x 5-1/4"	Each	1/12
ASP-6SW	6-1/2 Qt	10" x 5"	Each	1/12
ASP-8SW	8-1/2 Qt	10" x 6-1/2"	Each	1/6

## COVERS

ITEM	DESCRIPTION	UOM	CASE
ASP-2C	Cover for 2-1/2 Qt & 4-1/2 Qt	Each	12
ASP-5C	Cover for 6-1/2 Qt & 8-1/2 Qt	Each	12

## HEAVY-DUTY TAPERED ALUMINUM SAUCE PANS



ASP-5

ASP-5C

NSF ASP-SERIES

## ALUMINUM TAPERED SAUCE PANS

- ◆ 3003 Aluminum, 3.0mm thickness
- ◆ Flared sides for easier stirring and churning

ITEM	DESCRIPTION	SIZE (DIA X H)	UOM	CASE
ASP-1	1-1/2 Qt	5-3/4" x 3-5/8"	Each	12
ASP-2	2-1/2 Qt	7-3/4" x 4-1/8"	Each	12
ASP-3	3-3/4 Qt	9" x 4-1/4"	Each	12
ASP-4	4-1/4 Qt	9" x 4-5/8"	Each	12
ASP-5	5 Qt	9-3/4" x 5-1/8"	Each	12
ASP-7	7 Qt, Help Hdl	10-1/2" x 5-1/4"	Each	6
ASP-10	10 Qt, Help Hdl	11-1/2" x 5-3/4"	Each	6

## COVERS

ITEM	DESCRIPTION	UOM	CASE
ASP-1C	Cover for 1-1/2 Qt	Each	12
ASP-2C	Cover for 2-1/2 Qt	Each	12
ASP-3C	Cover for 3-3/4 Qt	Each	12
ASP-4C	Cover for 4-1/4 Qt	Each	12
ASP-5C	Cover for 5 Qt	Each	12
ASP-7C	Cover for 7 Qt	Each	12
ASP-10C	Cover for 10 Qt	Each	12

## ALUMINUM STIR FRY PANS



ASFP-11

ASFP-11NS

NSF ASFP-SERIES

PFOA FREE AFP-11NS



## ALUMINUM STIR FRY PANS

- ◆ 3003 Aluminum, 4.0mm thickness
- ◆ Ergonomic, heat-resistant silicone handle
- ◆ NSF listed

ITEM	DESCRIPTION	SIZE (DIA X H)	UOM	CASE
ASFP-11	Natural Finish	11" x 3-5/8"	Each	6
ASFP-11NS	Non-stick, Quantum2® Coating	11" x 3-5/8"	Each	6

**PASTA COOKER SET**

- ◆ Heavyweight 3003 aluminum pot, 3.5mm
- ◆ Includes 4 stainless steel inserts, 0.7mm thick
- ◆ Handles are heat-resistant up to 500°F (260°C)

ITEM	DESCRIPTION	UOM	CASE
APS-20	20 Qt Pasta Cooker Set	Set	1
APS-INS	Quarter-Size S/S Inset	Each	4
APS-PT	Replacement Pot	Each	1

**PASTA COOKER SET**



APS-20

**ALUMINUM STEAMER BASKETS**

ITEM	DESCRIPTION	UOM	CASE
ALSB-20	20 Qt Fits ALST-20, ALHP-20, AXHH-20, & AXS-20	Each	1
ALSB-32	32 Qt Fits ALST-32, ALHP-32, AXHH-32, & AXS-32	Each	1
ALSB-40	40 Qt Fits ALST-40, ALHP-40, AXHH-40, & AXS-40	Each	1
ALSB-60	60 Qt Fits ALST-60, ALHP-60, AXHH-60, & AXS-60	Each	1
ALSB-80	80 Qt Fits ALST-80, ALHP-80, AXHH-80, & AXS-80	Each	1

**ALUMINUM STEAMER BASKETS**



ALSB-32

- ◆ Excellent for even heat distribution at lower temperatures
- ◆ Reinforced rim and riveted handle for optimum durability
- ◆ Includes cover

**STEAMER SETS**

- ◆ Steamer sets are perfect for vegetables or pastas

ITEM	DESCRIPTION	SIZE (L X W X H)	UOM	CASE
ALDB-8S	8 Qt Set	10-3/8" x 8-5/8" x 7-1/2"	Set	1
ALDB-12S	12 Qt Set	11-1/4" x 9-5/8" x 9-1/4"	Set	1
ALDB-16S	16 Qt Set	12-5/16" x 9-1/2" x 10"	Set	1
ALDB-20S	20 Qt Set	13-1/8" x 10-1/8" x 11"	Set	1

**ALUMINUM DOUBLE BOILER & STEAMER SETS**



ALDB-20S

**DOUBLE BOILER SETS**

- ◆ Ideal for preparing delicate sauces, or melting chocolate and caramel
- ◆ NSF listed

ITEM	DESCRIPTION	SIZE (L X W X H)	UOM	CASE
ALDB-8	8 Qt Set	10-3/8" x 8-5/8" x 7-1/2"	Set	1
ALDB-12	12 Qt Set	11-1/4" x 9-5/8" x 9-1/4"	Set	1
ALDB-16	16 Qt Set	12-5/16" x 9-1/2" x 10"	Set	1
ALDB-20	20 Qt Set	13-1/8" x 10-1/8" x 11"	Set	1



ALDB-12





PASTA BASKETS

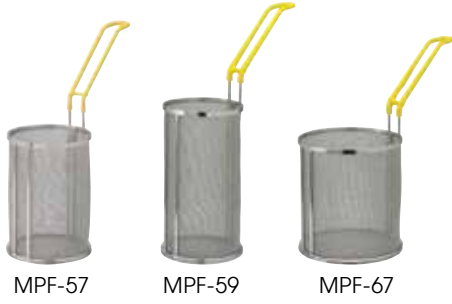

The Connoisseur extra-heavyweight premium pasta baskets stand up to constantly knocking the edges when removing pasta. Water flows freely through the cylindrical design for even cooking. Hang-dry with the open-end handles. Most pasta cooker machines and standard stock pots will accommodate these baskets.



SUPER FINE MESH PASTA BASKETS

- ◆ Electro-plated 18/8 stainless steel for corrosion resistance; reinforced frame
- ◆ Designed specifically for fine pasta, such as capellini and linguine

ITEM	DESCRIPTION	UOM	CASE
MPF-57	5"Dia x 7"H, Short	Each	1/8
MPF-59	5"Dia x 9"H, Tall	Each	1/8
MPF-67	6-1/2"Dia x 7"H, Wide	Each	1/8

PASTA BOIL BASKETS

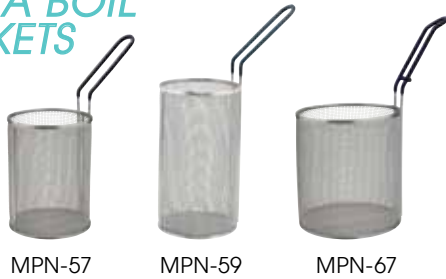

PASTA BOIL BASKETS

- ◆ 18/8 stainless steel frame and normal mesh makes it ideal for cooking capellini
- ◆ Fits standard pasta cookers and stock pots

ITEM	DESCRIPTION	UOM	CASE
MPN-57	5-1/4" Dia x 7"H, Short	Each	2/8
MPN-59	5" Dia x 9"H, Tall	Each	2/8
MPN-67	6-1/2" Dia x 7"H, Wide	Each	2/6

BULK PASTA BASKET



BULK PASTA/IMMERSION BASKET

- ◆ Durable 18/8 stainless steel
- ◆ Plastic coated handles rated for temperatures up to 250°F (120°C)
- ◆ Suitable for cooking all types of pasta in bulk
- ◆ Fits standard cookers

ITEM	DESCRIPTION	UOM	CASE
MPN-1613	16-1/4"L x 12-7/8"W x 10"H	Each	2

FRYER/PASTA COMBINATION PANS



ROUND 6 MESH WIRE FRY BASKETS

- ◆ Nickel plated 1/8" mesh

ITEM	DESCRIPTION	HANDLE	UOM	CASE
FBRS-8	8-1/2"Dia x 4-1/4"H	7-1/4"	Each	20
FBRS-9	9-1/2"Dia x 5-3/4"H	7-1/4"	Each	20
FBRS-11	10-1/2"Dia x 6"H	9"	Each	20

ROUND 4 MESH WIRE FRY BASKETS

- ◆ Nickel plated 1/4" mesh

ITEM	DESCRIPTION	HANDLE	UOM	CASE
FBR-8	8-1/2"Dia x 4-1/4"H	7-1/2"	Each	20
FBR-9	9-1/2"Dia x 5-3/4"H	8"	Each	20
FBR-11	10-1/2"Dia x 6"H	9"	Each	20

FRYER PANS

- ◆ Aluminum hook-on fry pan keeps fry basket secure

ITEM	DESCRIPTION	SIZE	UOM	CASE
ALSP-5	5.5 Qt	10"Dia x 5"H	Each	6
ALSP-7	7 Qt	10-7/8"Dia x 5-3/4"H	Each	6
ALSP-10	10 Qt	12"Dia x 6-1/4"H	Each	6

### FRY BASKETS

- ◆ One piece construction, non-welded structure
- ◆ Long lasting frame
- ◆ Heavy gauge wire handles are coated with high-temperature resistant colored plastic
- ◆ Nickel plated

ITEM	DESCRIPTION	COLOR	UOM	CASE
FB-05	11" x 5-3/8" x 4-1/8", 10" Handle	Black	Each	6
FB-10	12-1/8" x 6-1/2" x 5-3/8", 10" Handle	Orange	Each	6
FB-20	13-1/4" x 5-5/8" x 5-5/8", 10" Handle	Blue	Each	6
FB-25	12-7/8" x 6-1/2" x 5-3/8", 10" Handle	Red	Each	6
FB-30	13-1/4" x 6-1/2" x 5-7/8", 10" Handle	Green	Each	6
FB-35	13-1/4" x 9-1/2" x 6", 10" Handle	Grey	Each	6
FB-40	17" x 8-1/4" x 6", 12" Handle	Yellow	Each	6
FB-PS	Press with 11" Hdl, Fits FB-30	Red	Each	20
FB-PB	Press with 11" Hdl, Fits FB-10 & FB-20	Red	Each	20

### FRY BASKETS



### CHIMICHANGA/BURRITO FRY BASKET

- ◆ Heavy gauge wire handle coated with high-temperature resistant colored plastic
- ◆ Commercial quality 18/8 stainless steel
- ◆ Two hinged wire shelves; front and side hooks

ITEM	DESCRIPTION	UOM	CASE
FB-03	11-1/2" x 6" x 3-7/8", 9" Handle	Each	6



### TACO & TOSTADA BASKETS

- ◆ Nickel plated

ITEM	DESCRIPTION	UOM	CASE
TB-8	Taco Basket, Eight 6" Taco Shells	Each	8
TB-18	Tostada Basket, Eighteen 6" Tostada Shells	Each	8
TB-20	18" Hdl, Round Basket	Each	12
TB-22	18" Hdl, Triangle Basket	Each	12

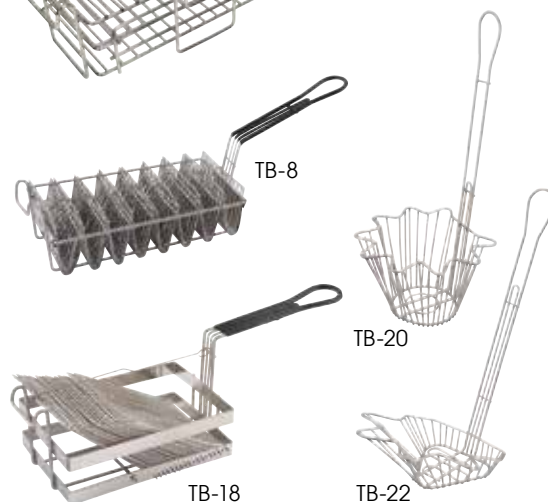

### FRENCH FRY BAGGERS

ITEM	DESCRIPTION	UOM	CASE
FFB-1R	Right Handle	Each	12/36
FFB-2	Dual Handles	Each	12/36

### FRYER FILTER STAND & FILTER

- ◆ Cloth filters are heat resistant up to 392°F (200°C)

ITEM	DESCRIPTION	UOM	CASE
FF-10	10" Fryer Filter Stand	Each	20
FF-RC	Rayon Cloth Filter Cones (10-Pcs/ Box)	Box	1/60

### FRYER ACCESSORIES



# STEAM TABLE PANS, STAINLESS STEEL

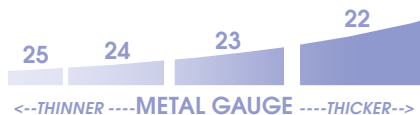

- ◆ Winco® offers the most complete collection of steam table pans in the industry
- ◆ Anti-jamming pans available in all gauges, straight sided pans available in standard weight
- ◆ Every gauge weight is made of 18/8 stainless steel
- ◆ NSF listed

**NSF** STEAM TABLE PANS

### HEAVYWEIGHT

### TRUE 24 GAUGE ANTI-JAMMING

### TRUE 23 GAUGE ANTI-JAMMING

### TRUE 22 GAUGE ANTI-JAMMING

SIZE	DEPTH	UOM	CASE	ITEM	ITEM	ITEM
Full-Size 20-3/4" x 12-3/4"	2-1/2"	Each	6/12	SPJM-102	SPJP-102	SPJH-102
	4"	Each	6/12	SPJM-104	SPJP-104	SPJH-104
	6"	Each	6/12	SPJM-106	SPJP-106	SPJH-106
Half-Size 10-3/8" x 12-3/4"	2-1/2"	Each	12/24	SPJM-202	SPJP-202	SPJH-202
	4"	Each	6/24	SPJM-204	SPJP-204	SPJH-204
	6"	Each	6/12	SPJM-206	SPJP-206	SPJH-206
Third-Size 6-7/8" x 12-3/4"	2-1/2"	Each	12/48	SPJM-302	SPJP-302	SPJH-302
	4"	Each	12/24	SPJM-304	SPJP-304	SPJH-304
	6"	Each	12/24	SPJM-306	SPJP-306	SPJH-306
Quarter-Size 10-5/6" x 6-5/16"	2-1/2"	Each	12/72	SPJM-402	SPJP-402	SPJH-402
	4"	Each	12/48	SPJM-404	SPJP-404	SPJH-404
	6"	Each	12/24	SPJM-406	SPJP-406	SPJH-406
Sixth-Size 6-7/8" x 6-5/16"	2-1/2"	Each	12/72	SPJM-602	SPJP-602	SPJH-602
	4"	Each	12/48	SPJM-604	SPJP-604	SPJH-604
	6"	Each	12/48	SPJM-606	SPJP-606	SPJH-606
Ninth-Size 6-3/4" x 4-1/4"	2-1/2"	Each	12/72	SPJM-902	SPJP-902	SPJH-902
	4"	Each	12/72	SPJM-904	SPJP-904	SPJH-904
	6"	Each	12/24			SPJH-906GN



**NSF** SPJH-906GN

WINCO® EXCLUSIVE SIZE

ADD 30% MORE COUNTER CAPACITY!

### STANDARD WEIGHT

### 25 GAUGE STRAIGHT-SIDED

### 25 GAUGE ANTI-JAMMING

SIZE	DEPTH	UOM	CASE	ITEM	ITEM
Full-Size 20-3/4" x 12-3/4"	2-1/2"	Each	6/12	SPF2	SPJL-102
	4"	Each	6/12	SPF4	SPJL-104
	6"	Each	6/12	SPF6	SPJL-106
Half-Size 10-3/8" x 12-3/4"	2-1/2"	Each	12/24	SPH2	SPJL-202
	4"	Each	6/24	SPH4	SPJL-204
	6"	Each	6/12	SPH6	SPJL-206
Third-Size 6-7/8" x 12-3/4"	2-1/2"	Each	12/48	SPT2	SPJL-302
	4"	Each	12/24	SPT4	SPJL-304
	6"	Each	12/24	SPT6	SPJL-306
Quarter-Size 10-5/6" x 6-5/16"	2-1/2"	Each	12/72	SPQ2	SPJL-402
	4"	Each	12/48	SPQ4	SPJL-404
	6"	Each	12/24	SPQ6	SPJL-406
Sixth-Size 6-7/8" x 6-5/16"	2-1/2"	Each	12/72	SPS2	SPJL-602
	4"	Each	12/48	SPS4	SPJL-604
	6"	Each	12/48	SPS6	SPJL-606
Ninth-Size 6-3/4" x 4-1/4"	2-1/2"	Each	12/72	SPN2	SPJL-902
	4"	Each	12/72	SPN4	SPJL-904

### SPECIALTY SIZES 25 GAUGE

SIZE	DEPTH	CASE	UOM	ITEM
Full-Size 20-3/4" x 12-3/4"	1-1/4"	6/12	Each	SPF1
Half-Size 10-3/8" x 12-3/4"	1-1/4"	12/24	Each	SPH1
Two-Third Size 14" x 12-7/8"	2-1/2"	12/24	Each	SPTT2
	4"	6/24	Each	SPTT4
	6"	6/12	Each	SPTT6

### SPECIALTY SIZES 22 GAUGE

SIZE	DEPTH	CASE	UOM	ITEM
Eighteenth-Size	2"	24/96	Each	SPJH-1802



**NSF** STEAM TABLE PANS

New Item



### GET-A-GRIP™ CHAFING DISH PANS

- ◆ Patented pan and handle system prevents steam burns
- ◆ Stainless steel; NSF listed

ITEM	DESCRIPTION	UOM	CASE
SPF2-HD	Full-Size Pan, NSF	Each	6

### 22 GAUGE PERFORATED STEAM PANS

- ◆ Stainless steel; NSF listed

ITEM	DESCRIPTION	UOM	CASE
SPJH-102PF	Full-Size 2-1/2" Perf	Each	6/12
SPJH-104PF	Full-Size 4" Perf	Each	6/12
SPJH-106PF	Full-Size 6" Perf	Each	6/12
SPJH-202PF	Half-Size 2-1/2" Perf	Each	12/24
SPJH-204PF	Half-Size 4" Perf	Each	6/24
SPJH-206PF	Half-Size 6" Perf	Each	6/12

### 25 GAUGE PERFORATED STEAM PANS

- ◆ Stainless steel; NSF listed

ITEM	DESCRIPTION	UOM	CASE
SPFP2	Full-Size 2-1/2" Perf	Each	6/12
SPFP4	Full-Size 4" Perf	Each	6/12
SPFP6	Full-Size 6" Perf	Each	6/12
SPHP2	Half-Size 2-1/2" Perf	Each	6/24
SPHP4	Half-Size 4" Perf	Each	6/24
SPHP6	Half-Size 6" Perf	Each	6/12

### 22 GAUGE HALF-LONG SIZE PANS

- ◆ Stainless steel and anti-jamming; NSF listed

ITEM	DESCRIPTION	UOM	CASE
SPJH-101	1-1/4" Full-Size	Each	6/12
SPJH-201	1-1/4" Half-Size	Each	12/24
SPJH-2HL	2-1/2" Half-Long Size Pan	Each	6/24
SPJH-4HL	4" Half-Long Size Pan	Each	6/24
SPJH-6HL	6" Half-Long Size Pan	Each	6/12

### 25 GAUGE HALF-LONG SIZE PANS & COVERS

- ◆ Stainless steel and anti-jamming; NSF listed

ITEM	DESCRIPTION	UOM	CASE
SPJL-2HL	2-1/2" Half-Long Size Pan	Each	6/24
SPJL-4HL	4" Half-Long Size Pan	Each	6/24
SPJL-6HL	6" Half-Long Size Pan	Each	6/12
SPJL-HCN	Half-Long Cover, Notched	Each	12/24
SPJL-HCS	Half-Long Cover, Solid	Each	12/24

### DIVIDED FOOD PANS

- ◆ Stainless steel

ITEM	DESCRIPTION	UOM	CASE
SPFD2	Full-Size 2-1/2"	Each	6/12
SPFD-2R	Round, fits 103A, 103B, 602 and 308A chafers	Each	10

### WATER & SPILLAGE PANS

- ◆ Stainless steel

ITEM	DESCRIPTION	UOM	CASE
C-WPF	Full-Size Dripless Water Pan, 4" Depth, Flat Edge	Each	6
C-WPF6	Full-Size Spillage Pan, 6" Depth, Upright Standing Edge	Each	5/10
C-WPP	Full-Size Spillage Pan, 6" Depth, Flat Edge	Each	6/12

### SPECIALTY PANS



Patented Handle System



SPF2-HD NSF



SPJH/SPFP-SERIES PERFORATED STEAM PANS



SPJH-SERIES NSF

SPFP-SERIES NSF



SPJH/SPJL-SERIES HALF-LONG SIZE PANS



SPJH-SERIES NSF

SPJL-SERIES NSF



SPFD2 NSF



SPFD-2R

### WATER & SPILLAGE PANS



C-WPF

C-WPP NSF



Flat edge



Upright standing edge



C-WPF6 NSF



## ROLL-TOP COVER



C-RCF

SEE PAGE 186 FOR FOOD PAN



Open



Closed on a food pan



Open on a food pan

## ROLL-TOP COVER

- ◆ 18/8 satin finish stainless steel
- ◆ Fits full-size 12" x 20" food well opening
- ◆ Easy access hinged cover
- ◆ Plastic handle is heat resistant up to 220°F (105°C)

ITEM	DESCRIPTION	UOM	CASE
C-RCF	20-3/4"L x 13"W x 11-7/8"H	Each	1/2

## STEAM PAN COVERS

SEE PAGE 193 FOR POLYCARBONATE COVERS



C-HFC1



C-DCH

C-HDC



SPSCF

NEW SIZE

NSF SOLID COVERS



SPCF

NEW SIZE

NSF SLOTTED COVERS

## SPECIALTY COVERS

ITEM	DESCRIPTION	UOM	CASE
C-HFC1	Flat Hinged Cover, S/S	Each	6/12
C-HDC	Hinged Dome Cover with Handle, S/S	Each	12
C-DCF	Full-Size Dome Cover with Handle, S/S	Each	12
C-DCH	Half-Size Dome Cover with Handle, S/S	Each	24

## FLAT COVERS

- ◆ 18/8 stainless steel
- ◆ NSF listed

ITEM	DESCRIPTION	UOM	CASE
SPSCF	1/1 Solid Cover	Each	12/24
SPSCH	1/2 Solid Cover	Each	12/48
SPSCT	1/3 Solid Cover	Each	12/72
SPSCQ	1/4 Solid Cover	Each	12/72
SPSCS	1/6 Solid Cover	Each	12/72
SPSCN	1/9 Solid Cover	Each	12/72
SPSCN-GN	1/9 Solid Cover for SPJH-906GN	Each	10/40
SPSCTT	2/3 Solid Cover	Each	12/24
SPCF	1/1 Slotted Cover	Each	12/24
SPCH	1/2 Slotted Cover	Each	12/48
SPCT	1/3 Slotted Cover	Each	12/72
SPCQ	1/4 Slotted Cover	Each	12/72
SPCS	1/6 Slotted Cover	Each	12/72
SPCN	1/9 Slotted Cover	Each	12/72
SPCN-GN	1/9 Slotted Cover for SPJH-906GN	Each	10/40
SPCTT	2/3 Slotted Cover	Each	12/24

## ANGLED DISPLAY ADAPTOR



ADB-4

## ANGLED DISPLAY ADAPTOR

Add some dimension to a buffet with an angled display adaptor to give steam table pans a lift so guests can have better visibility and easier access to food.

ITEM	DESCRIPTION	UOM	CASE
ADB-4	Full-Size, S/S	Each	2/6

### STAINLESS STEEL STEAM PAN GRATES

- ◆ Feet elevate food to keep from sticking to steam pan
- ◆ Can also be used as a cooling or icing rack
- ◆ Rust resistant

ITEM	DESCRIPTION	STEAM PAN SIZE	UOM	CASE
PGWS-1018	For Full-Size	10" x 18"	Each	12/48
PGWS-810	For Half-Size	8" x 10"	Each	12/48
PGWS-510	For Third-Size	5" x 10-1/2"	Each	12/48

### STEAM PAN GRATES

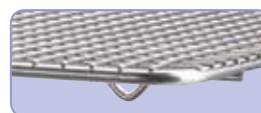

Raised Feet

SEE PAGE 201  
FOR SHEET PAN  
GRATES

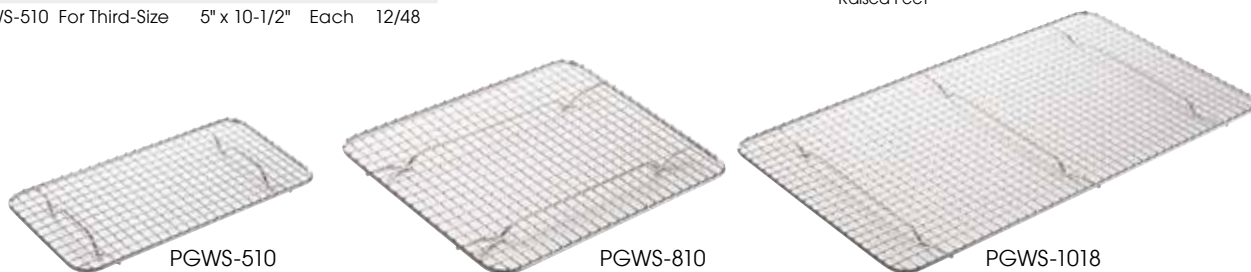

### CHROME-PLATED STEAM PAN GRATES

ITEM	DESCRIPTION	STEAM PAN SIZE	UOM	CASE
PGW-1018	For Full-Size	10" x 18"	Each	12/48
PGW-810	For Half-Size	8" x 10"	Each	12/48
PGW-510	For Third-Size	5" x 10-1/2"	Each	12/48

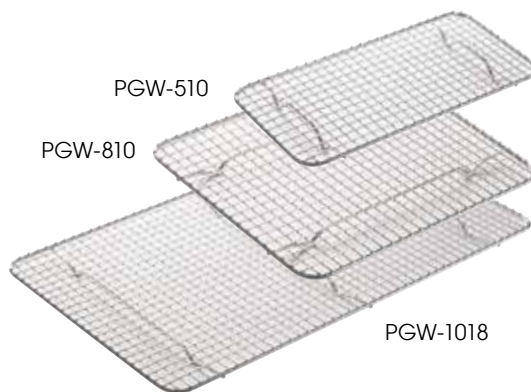

### FALSE BOTTOMS

- ◆ 18/8 stainless steel
- ◆ Rust resistant
- ◆ Fits standard steam pan sizes

ITEM	DESCRIPTION	UOM	CASE
SPFB-1	Full-Size	Each	10/20
SPFB-2	Half-Size	Each	10/40
SPFB-3	Third-Size	Each	12/48
SPFB-4	Quarter-Size	Each	12/48
SPFB-6	Sixth-Size	Each	12/72
SPFB-9	Ninth-Size	Each	12/72

### FALSE BOTTOMS

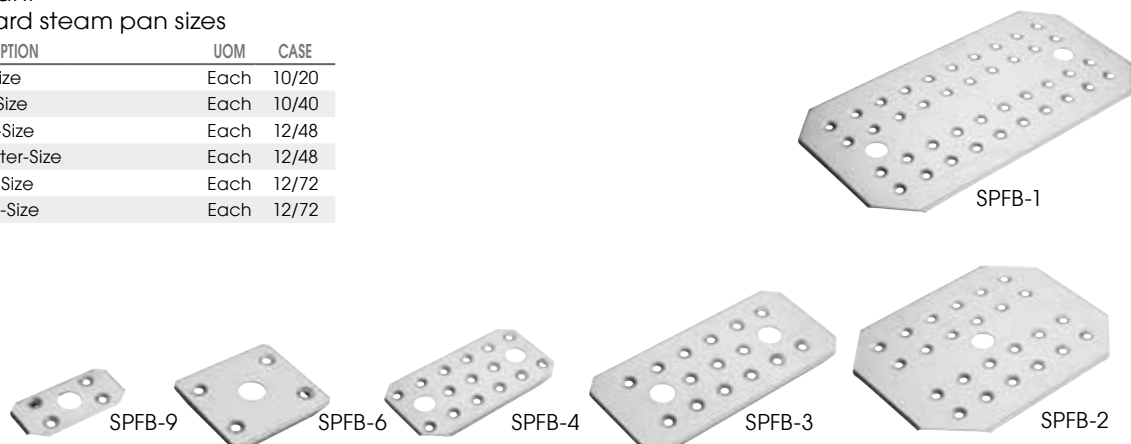

### ADAPTOR BARS

- ◆ Stainless steel

ITEM	DESCRIPTION	UOM	CASE
ADB-12	12"L x 1"W	Each	12/144
ADB-20	20"L x 1"W	Each	12/120

### ADAPTOR BARS

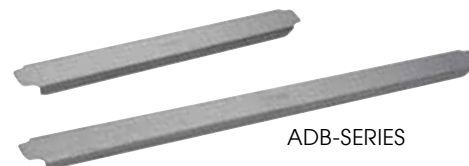



## Step up to Winco Prime® – A Cut Above

Winco Prime® products are made with industry approved materials that comply with or exceed accepted industry standards. All products in the Winco Prime family are NSF® listed to give a comfort level that every effort has been made to provide a safe and durable product at an affordable price. Winco Prime® products are safe to be used and will hold up well in the most demanding food service environment!

### NSF® BAIN-MARIES

### NSF® INSETS



**NEW** BAMN-6

**NEW** BAMN-6C

**NEW** INSN-7

INSC-7M

#### WINCO PRIME® BAIN-MARIES (NSF)

◆ Stainless steel satin finish

ITEM	DESCRIPTION	SIZE	UOM	CASE
BAMN-1.25	1.25 Qt	5" x 6"	Each	6/48
BAMN-1.5	1.5 Qt	5-1/2" x 5-1/4"	Each	6/48
BAMN-2	2 Qt	5-3/4" x 7"	Each	6/48
BAMN-3.5	3.5 Qt	7-1/4" x 7"	Each	6/36
BAMN-4.25	4.25 Qt	7-1/4" x 7-3/4"	Each	6/36
BAMN-6	6 Qt	8" x 8-3/4"	Each	6/24
BAMN-8.25	8.25 Qt	9" x 9-3/4"	Each	6/24
BAMN-12	12 Qt	10" x 10-1/2"	Each	6/12

#### BAIN-MARIE COVERS (NSF)

◆ Stainless steel satin finish

ITEM	DESCRIPTION	UOM	CASE
BAMN-1.25C	Cover for BAMN-1.25	Each	12/144
BAMN-1.5C	Cover for BAMN-1.5	Each	12/144
BAMN-2C	Cover for BAMN-2	Each	12/144
BAMN-3.5C	Cover for BAMN-3.5	Each	12/144
BAMN-4.25C	Cover for BAMN-4.25	Each	12/72
BAMN-6C	Cover for BAMN-6	Each	12/72
BAMN-8.25C	Cover for BAMN-8.25	Each	12/48
BAMN-12C	Cover for BAMN-12	Each	12/24

#### WINCO PRIME® INSET PANS (NSF)

◆ Stainless steel satin finish

ITEM	DESCRIPTION	SIZE	UOM	CASE
INSN-2.5	2.5 Qt	6" x 7-1/2"	Each	6/36
INSN-4	4 Qt	7-1/2" x 7-1/2"	Each	6/36
INSN-7	7 Qt	9-1/2" x 8"	Each	6/24
INSN-11	11 Qt	11-1/2" x 9"	Each	6/12

#### INSET COVERS (NON-NSF)

◆ Stainless steel mirror finish

ITEM	DESCRIPTION	UOM	CASE
INSC-2.5	Cover for INSN-2.5	Each	6/72
INSC-4	Cover for INSN-4	Each	6/36
INSC-7M	Cover for INSN-7	Each	6/48
INSC-11M	Cover for INSN-11	Each	6/36

### BAIN-MARIES

- ◆ Stainless steel mirror finish
- ◆ Bent rim for easier handling and lifting

ITEM	DESCRIPTION	SIZE	UOM	CASE
BAM-1.25	1.25 Qt	5" x 6"	Each	6/48
BAM-1.5	1.5 Qt	5-1/2" x 5-1/4"	Each	6/48
BAM-2	2 Qt	5-3/4" x 7"	Each	6/48
BAM-3.5	3.5 Qt	7-1/4" x 7"	Each	6/36
BAM-4.25	4.25 Qt	7-1/4" x 7-3/4"	Each	6/36
BAM-6	6 Qt	8" x 8-3/4"	Each	6/24
BAM-8.25	8.25 Qt	9" x 9-3/4"	Each	6/24
BAM-12	12 Qt	10" x 10-1/2"	Each	3/6

### BAIN-MARIE COVERS

- ◆ Stainless steel mirror finish

ITEM	DESCRIPTION	UOM	CASE
BAMC-1.25	For 1.25 Qt Bain Marie	Each	12/144
BAMC-2	For 2 Qt Bain Marie	Each	12/144
BAMC-3.5	For 3.5 Qt Bain Marie	Each	12/144
BAMC-4.25	For 4.25 Qt Bain Marie	Each	12/72
BAMC-6	For 6 Qt Bain Marie	Each	12/72
BAMC-8.25	For 8.25 Qt Bain Marie	Each	12/48
BAMC-12	For 12 Qt Bain Marie	Each	12/24

### INSET PAN

- ◆ Stainless steel mirror finish

ITEM	DESCRIPTION	SIZE	UOM	CASE
INS-2.5	2.5 Qt	6" x 7-1/2"	Each	6/36
INS-4.0	4 Qt	7-1/2" x 7-1/2"	Each	6/36
INS-7.0M	7 Qt, 24 gauge	9-1/2" x 8"	Each	6/24
INS-11.0M	11 Qt, 24 gauge	11-1/2" x 9"	Each	6/12

### INSET COVERS

- ◆ Stainless steel mirror finish

ITEM	DESCRIPTION	UOM	CASE
INSC-2.5	For 2.5 Qt Inset	Each	6/72
INSC-4	For 4 Qt Inset	Each	6/36
INSC-7M	For 7 Qt Inset	Each	6/48
INSC-11M	For 11 Qt Inset	Each	6/36

### HINGED COVERS

- ◆ Stainless steel mirror finish

ITEM	DESCRIPTION	UOM	CASE
INSH-7	For 7 Qt Inset	Each	6/24
INSH-11	For 11 Qt Inset	Each	6/24

### ADAPTOR PLATES

- ◆ Stainless steel

ITEM	DESCRIPTION	SIZE	UOM	CASE
ADP-608	6-3/8" and 8-3/8" Inset Holes	Fits 4 Qt and 7 Qt	Each	10
ADP-610	6-3/8" and 10-3/8" Inset Holes	Fits 4 Qt and 11 Qt	Each	10
ADP-666	Three 6-3/8" Inset Holes	Fits 4 Qt	Each	10
ADP-808	Two 8-3/8" Inset Holes	Fits 7 Qt	Each	10
ADP-810	8-3/8" and 10-3/8" Inset Holes	Fits 7 Qt and 11 Qt	Each	10
ADP-444	Adaptor Plate, Six 4-3/4" Inset Holes	Fits 2.5 Qt	Each	10

### BAIN-MARIES



BAM-6



BAMC-SERIES

### INSETS



INS-7.0M



INSC-7M

INSH-7

### ADAPTOR PLATES

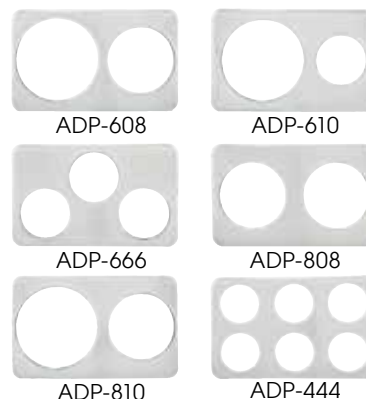

OVERALL SIZE: 21" X 13"



## HIGH-HEAT NYLON FOOD PANS

# Blaze™

## HIGH HEAT PANS

By Winco®

NEW

AVAILABLE IN MARCH 2018

WITHSTANDS TEMPS FROM -40°F TO 400°F



HHP204

### PAN SIZING

SIZE	DIMENSIONS
Full-Size	20-3/4" x 12-1/2"
1/2-Size	12-3/4" x 10-3/8"
1/3-Size	12-3/4" x 6-7/8"
1/4-Size	10-1/4" x 6-1/4"
1/6-Size	6-3/4" x 6-1/4"



HHP304

NEW

AVAILABLE IN MARCH 2018



HHP300S

NEW

AVAILABLE IN MARCH 2018



HHP20DS

NSF

BPA FREE

HHP-SERIES

## HIGH-HEAT NYLON FOOD PANS, COVERS AND DRAIN SHELVES

Resistant to high temperatures, these can be used in the microwave, in the oven and on steam tables.

- ◆ Reinforced, rounded edges for added strength
- ◆ Easily transport from cold storage to warm applications
- ◆ Dishwasher safe
- ◆ NSF listed; BPA-free

### HIGH-HEAT FOOD PANS

- ◆ Rounded corners and smooth finish for easy cleanup

ITEM	SIZE	DEPTH	CAPACITY	UOM	CASE
HHP104	Full-Size	4"	13.0L	Each	6/12
HHP106		6"	19.5L	Each	6/12
HHP204	1/2-Size	4"	5.9L	Each	6/24
HHP206		6"	8.9L	Each	6/12
HHP304	1/3-Size	4"	3.6L	Each	12/24
HHP306		6"	5.3L	Each	6/24
HHP404	1/4-Size	4"	2.5L	Each	12/36
HHP406		6"	3.7L	Each	6/24
HHP604	1/6 Size	4"	1.5L	Each	12/48
HHP606		6"	2.2L	Each	6/24

### HIGH-HEAT NYLON COVERS

ITEM	DESCRIPTION	SIZE	UOM	CASE
HHP100S	Full-Size Cover for HHP104/106	20-3/4" x 12-3/4"	Each	12/24
HHP200S	1/2-Size Cover for HHP204/206	10-3/8" x 12-3/4"	Each	12/48
HHP300S	1/3-Size Cover for HHP304/306	6-7/8" x 12-3/4"	Each	12/72
HHP400S	1/4-Size Cover for HHP404/406	10-5/6" x 6-5/16"	Each	12/72
HHP600S	1/6-Size Cover for HHP604/606	6-7/8" x 6-5/16"	Each	12/72

### HIGH-HEAT NYLON DRAIN SHELVES

ITEM	DESCRIPTION	SIZE	UOM	CASE
HHP10DS	Full-size	18-5/16" x 10-1/4"	Each	10/20
HHP20DS	1/2-size	10-1/4" x 7-7/8"	Each	10/40
HHP30DS	1/3 size	10-1/4" x 4-7/16"	Each	20/80
HHP40DS	1/4 size	8" x 3-15/16"	Each	20/80
HHP60DS	1/6 size	4-7/16" x 4-1/4"	Each	20/120

# POLYCARBONATE FOOD PANS

## PAN SIZING

SIZE	DIMENSIONS
Full-Size	20-3/4" x 12-1/2"
1/2-Size	12-3/4" x 10-3/8"
1/3-Size	12-5/8" x 6-7/8"
1/4-Size	10-1/4" x 6-1/4"
1/6-Size	6-3/4" x 6-1/4"
1/9-Size	6-7/8" x 4-1/4"

WITHSTAND  
TEMPS FROM  
-40°F TO 210°F



**NEW  
SIZE**  
SP7906

SEE PAGE 189  
FOR ADAPTOR  
BARS

## FOOD PANS

◆ NSF listed

ITEM	PAN SIZE	DEPTH	UOM	CASE
SP7102	Full-Size	2-1/2"	Each	6/12
SP7104	Full-Size	3-1/2"	Each	6/12
SP7106	Full-Size	5-1/2"	Each	6/12
SP7108	Full-Size	7-3/4"	Each	6/12
SP7202	1/2-Size	2-1/2"	Each	12/24
SP7204	1/2-Size	3-1/2"	Each	6/24
SP7206	1/2-Size	5-1/2"	Each	6/12
SP7208	1/2-Size	7-3/4"	Each	6/12
SP7302	1/3-Size	2-1/2"	Each	12/24
SP7304	1/3-Size	3-1/2"	Each	12/24
SP7306	1/3-Size	5-1/2"	Each	6/24
SP7308	1/3-Size	7-3/4"	Each	6/12
SP7402	1/4-Size	2-1/2"	Each	12/36
SP7404	1/4-Size	3-1/2"	Each	12/36
SP7406	1/4-Size	5-1/2"	Each	6/24
SP7602	1/6-Size	2-1/2"	Each	12/36
SP7604	1/6-Size	3-1/2"	Each	12/48
SP7606	1/6-Size	5-1/2"	Each	6/24
SP7902	1/9-Size	2-1/2"	Each	12/72
SP7904	1/9-Size	3-1/2"	Each	12/72
SP7906	1/9-Size	6"	Each	12/72

## COVERS FOR FOOD PANS

◆ NSF listed

ITEM	COVER STYLE	UOM	CASE																							
SP7100C	Slotted	Each	12/24																							
SP7100S	Solid	Each	12/24																							
SP7200C	Slotted	Each	12/48																							
SP7200S	Solid	Each	12/48																							
SP7300C	Slotted	Each	12/72																							
SP7300S	Solid	Each </tr <tr> <td>SP7400C</td> <td>Slotted</td> <td>Each</td> <td>12/72</td> </tr> <tr> <td>SP7400S</td> <td>Solid</td> <td>Each</td> <td>12/72</td> </tr> <tr> <td>SP7600C</td> <td>Slotted</td> <td>Each</td> <td>12/72</td> </tr> <tr> <td>SP7600S</td> <td>Solid</td> <td>Each</td> <td>12/72</td> </tr> <tr> <td>SP7900C</td> <td>Slotted</td> <td>Each</td> <td>12/72</td> </tr> <tr> <td>SP7900S</td> <td>Solid</td> <td>Each</td> <td>12/72</td> </tr>	SP7400C	Slotted	Each	12/72	SP7400S	Solid	Each	12/72	SP7600C	Slotted	Each	12/72	SP7600S	Solid	Each	12/72	SP7900C	Slotted	Each	12/72	SP7900S	Solid	Each	12/72
SP7400C	Slotted	Each	12/72																							
SP7400S	Solid	Each	12/72																							
SP7600C	Slotted	Each	12/72																							
SP7600S	Solid	Each	12/72																							
SP7900C	Slotted	Each	12/72																							
SP7900S	Solid	Each	12/72																							

NSF®

## DOMES COVERS

- ◆ Made of durable polycarbonate plastic
- ◆ C-DP1, C-DPF1 and C-DPFH fit full-size steam table pans and poly pans
- ◆ C-DP2 and C-DPF2 fit half-size steam table pans and poly pans
- ◆ NSF listed

ITEM	DESCRIPTION	SIZE	UOM	CASE
C-DP1	Full-Size Cover, NSF	21-1/2" x 13-3/4"	Each	12
C-DP2	1/2-Size Cover, NSF	13-1/2" x 11"	Each	24
C-DPF1	Full-Size Flip Cover, NSF	21-1/2" x 13-3/4"	Each	12
C-DPF2	1/2-Size Cut-out Cover, NSF	13-1/2" x 11"	Each	24
C-DPFH	Full-Size Hinged Cover	21" x 13"	Each	12



C-DP1

C-DPF2

C-DP2

C-DPFH

C-SERIES NSF®

## DRAIN SHELVES

◆ NSF listed

ITEM	DESCRIPTION	SIZE	UOM	CASE
SP71DS	Full-Size	18-5/16" x 10-1/4"	Each	10/20
SP72DS	1/2-Size	10-1/4" x 7-7/8"	Each	10/40
SP73DS	1/3-Size	10-1/4" x 4-7/16"	Each	20/80
SP74DS	1/4-Size	8" x 3-15/16"	Each	20/80
SP76DS	1/6-Size	4-7/16" x 4-1/4"	Each	20/120
SP79DS	1/9-Size	4-7/16" x 2-1/8"	Each	60/120



**NEW  
SIZE**  
SP79DS

SP7-SERIES NSF®

## SQUARE FOOD STORAGE CONTAINERS



NSF® PCSC-SERIES



NSF® BPA FREE PTSC-SERIES



NSF® BPA FREE PESC-SERIES

SEE PAGE 251 FOR MORE OF THE ALLERGEN-FREE LINE



PECC-128P, PECC-68P, PECC-24P



PECC-24, PECC-68, PECC-128



PECC-S, PECC-M, PECC-L

Winco® offers a wide selection of NSF listed boxes and containers to meet all your food storage needs. Our food storage containers come in round and square shapes, in both clear polycarbonate (PC) and polypropylene (PP).

- ◆ Clear polycarbonate is extremely durable, stackable, withstands temperatures from -40°F to 210°F, and is ideal for the storage and transport of raw or prepared food
- ◆ Polypropylene is stain resistant, withstands temperatures from -40°F to 160°F, and is ideal for the storage and transport of prepared food only
- ◆ Built-in handles, graduation markings in liters and quarts
- ◆ Dishwasher safe

### CLEAR POLYCARBONATE

- ◆ NSF listed

ITEM	DESCRIPTION	UOM	CASE
PCSC-2C	2 Qt	Each	12/60
PCSC-4C	4 Qt	Each	12/48
PCSC-6C	6 Qt	Each	12/24
PCSC-8C	8 Qt	Each	12/24
PCSC-12C	12 Qt	Each	12
PCSC-18C	18 Qt	Each	12
PCSC-22C	22 Qt	Each	6

### TRANSLUCENT POLYPROPYLENE

- ◆ NSF listed, BPA-free

ITEM	DESCRIPTION	UOM	CASE
PTSC-2	2 Qt	Each	12/60
PTSC-4	4 Qt	Each	12/48
PTSC-6	6 Qt	Each	12/24
PTSC-8	8 Qt	Each	12/24
PTSC-12	12 Qt	Each	12
PTSC-18	18 Qt	Each	12
PTSC-22	22 Qt	Each	6

### WHITE POLYPROPYLENE

- ◆ NSF listed, BPA-free

ITEM	DESCRIPTION	UOM	CASE
PESC-2	2 Qt	Each	12/60
PESC-4	4 Qt	Each	12/48
PESC-6	6 Qt	Each	12/24
PESC-8	8 Qt	Each	12/24
PESC-12	12 Qt	Each	12
PESC-18	18 Qt	Each	12
PESC-22	22 Qt	Each	6

### POLYETHYLENE ALLERGEN-FREE COVERS

Solve the challenges of maintaining an allergen-aware kitchen! Improve customer dining experiences while raising the bar for food safety. Prevent cross-contaminating allergens with the extensive line of Allergen-Free tools by Winco®. Whether it's gluten, nuts or more, use this stand-out purple color to designate these storage containers as allergen-free.

ITEM	DESCRIPTION	COLOR	UOM	CASE
PECC-24P	Fits 2 Qt & 4 Qt	Purple	Each	12
PECC-68P	Fits 6 Qt & 8 Qt	Purple	Each	12
PECC-128P	Fits 12 Qt, 18 Qt, 22 Qt	Purple	Each	6

### POLYETHYLENE COVERS

ITEM	DESCRIPTION	COLOR	UOM	CASE
PECC-24	Fits 2 Qt & 4 Qt	Green	Each	12
PECC-68	Fits 6 Qt & 8 Qt	Red	Each	12
PECC-128	Fits 12 Qt, 18 Qt, 22 Qt	Blue	Each	6
PECC-S	Fits 2 Qt & 4 Qt	White	Each	12
PECC-M	Fits 6 Qt & 8 Qt	White	Each	12
PECC-L	Fits 12 Qt, 18 Qt, 22 Qt	White	Each	6

Winco® offers a wide selection of NSF listed boxes and containers to meet all your food storage needs. Our food storage containers come in round and square shapes, in both clear polycarbonate and polypropylene.

- ◆ Clear polycarbonate is extremely durable, stackable, withstands temperatures from -40°F to 210°F, and is ideal for the storage and transport of raw or prepared food
- ◆ Polypropylene is stain resistant, withstands temperatures from -40°F to 160°F, and is ideal for the storage and transport of prepared food only
- ◆ Built-in handles, graduation markings in liters and quarts
- ◆ Dishwasher safe

## ROUND FOOD STORAGE CONTAINERS

### CLEAR POLYCARBONATE

- ◆ NSF listed

ITEM	DESCRIPTION	UOM	CASE
PCRC-1	1 Qt	Each	48
PCRC-2	2 Qt	Each	24
PCRC-4	4 Qt	Each	12
PCRC-6	6 Qt	Each	12
PCRC-8	8 Qt	Each	12
PCRC-12	12 Qt	Each	12
PCRC-18	18 Qt	Each	6
PCRC-22	22 Qt	Each	6
PCRC-1C	Cover, Fits 1 Qt	Each	12
PCRC-24C	Cover, Fits 2 Qt and 4 Qt	Each	12
PCRC-68C	Cover, Fits 6 Qt and 8 Qt	Each	12
PCRC-1222C	Cover, Fits 12 Qt, 18 Qt, 22 Qt	Each	6



PCRC-6  
PCRC-24C

PCRC-2

PCRC-8

PCRC-SERIES **NSF**

### TRANSLUCENT POLYPROPYLENE

- ◆ NSF listed, BPA-free

ITEM	DESCRIPTION	UOM	CASE
PTRC-1	1 Qt	Each	48
PTRC-2	2 Qt	Each	24
PTRC-4	4 Qt	Each	12
PTRC-6	6 Qt	Each	12
PTRC-8	8 Qt	Each	12
PTRC-12	12 Qt	Each	12
PTRC-18	18 Qt	Each	6
PTRC-22	22 Qt	Each	6
PTRC-1C	Cover, Fits 1 Qt	Each	12
PTRC-24C	Cover, Fits 2 Qt and 4 Qt	Each	12
PTRC-68C	Cover, Fits 6 Qt and 8 Qt	Each	12
PTRC-1222C	Cover, Fits 12 Qt, 18 Qt, 22 Qt	Each	6



PTRC-6  
PTRC-24C

PTRC-2

PTRC-8

PTRC-SERIES **NSF**  
**BPA FREE**

### WHITE POLYPROPYLENE

- ◆ NSF listed, BPA-free

ITEM	DESCRIPTION	UOM	CASE
PPRC-1W	1 Qt	Each	48
PPRC-2W	2 Qt	Each	24
PPRC-4W	4 Qt	Each	12
PPRC-6W	6 Qt	Each	12
PPRC-8W	8 Qt	Each	12
PPRC-12W	12 Qt	Each	12
PPRC-18W	18 Qt	Each	6
PPRC-22W	22 Qt	Each	6
PPRC-1C	Cover, Fits 1 Qt	Each	12
PPRC-24C	Cover, Fits 2 Qt and 4 Qt	Each	12
PPRC-68C	Cover, Fits 6 Qt and 8 Qt	Each	12
PPRC-1222C	Cover, Fits 12 Qt, 18 Qt, 22 Qt	Each	6



PPRC-6W  
PPRC-24C

PPRC-2W

PPRC-8W

PPRC-SERIES **NSF**  
**BPA FREE**



## FOOD STORAGE BOXES



PFSF-C



**NSF** PFSF & PFSH-SERIES

### HEAVYWEIGHT CLEAR POLYCARBONATE

- ◆ Full-size measures 18" x 26"
- ◆ Half-size measures 18" x 12"
- ◆ Withstands temperatures from -40°F to 212°F
- ◆ NSF listed

ITEM	DESCRIPTION	CAPACITY	UOM	CASE
PFSF-6	Full-Size 6"	9 gal	Each	6
PFSF-9	Full-Size 9"	13 gal	Each	4
PFSF-12	Full-Size 12"	17 gal	Each	3
PFSF-15	Full-Size 15"	22 gal	Each	3
PFSF-C	Full-Size Cover for PFSF-Series		Each	12
PFSH-3	Half-Size 3-1/2"	1.75 gal	Each	12
PFSH-6	Half-Size 6"	3.5 gal	Each	6
PFSH-9	Half-Size 9"	5 gal	Each	6
PFSH-C	Half-Size Cover for PFSH-Series		Each	24

### WHITE POLYPROPYLENE

- ◆ Full-size measures 18" x 26"
- ◆ Half-size measures 18" x 12"
- ◆ Withstands temperatures from -40°F to 160°F
- ◆ NSF listed, BPA-free

ITEM	DESCRIPTION	CAPACITY	UOM	CASE
PFFW-3	Full-Size 3"	5 gal	Each	6
PFFW-6	Full-Size 6"	9 gal	Each	6
PFFW-9	Full-Size 9"	13 gal	Each	6
PFFW-12	Full-Size 12"	17 gal	Each	6
PFFW-15	Full-Size 15"	22 gal	Each	6
PFFW-C	Full-Size Cover for PFFW-Series		Each	6
PFHW-3	Half-Size 3"	1.75 gal	Each	12
PFHW-6	Half-Size 6"	3.5 gal	Each	12
PFHW-9	Half-Size 9"	5 gal	Each	12
PFHW-C	Half-Size Cover for PFHW-Series		Each	6



PFFW-C



**NSF**  
**BPA FREE** PFFW & PFHW-SERIES

## DRAIN SHELVES



PFSF-DS

**NSF** DRAIN SHELVES

### POLYCARBONATE DRAIN SHELVES

- ◆ NSF listed

ITEM	DESCRIPTION	SIZE	UOM	CASE
PFSF-DS	Drain Shelf for PFSF	18" x 26"	Each	12
PFSH-DS	Drain Shelf for PFSH	12" x 18"	Each	24

**DURABLE POLYPROPYLENE INGREDIENT BINS**

- ◆ Ideal for mobile storage in the kitchen
- ◆ Advanced super-clasp lid design makes it easy to scoop ingredients without removing the entire cover
- ◆ Easily identify contents through the clear plastic polycarbonate front cover & keep foods fresher longer
- ◆ 3" caster wheels with brakes make this bin convenient to move from one kitchen work area to another
- ◆ Scoop handle designed to remain out of ingredients and prevent contamination
- ◆ NSF listed

ITEM	DESCRIPTION	SIZE	UOM	CASE
IB-21	21 Gal	13" x 29-1/4" x 28"	Set	1
IB-27	27 Gal	15-1/2" x 29-1/2" x 28"	Set	1
IB-C3	3" Caster For IB-21 and IB-27		Each	1
IB-C3B	Caster w/Break For IB-21 and IB-27		Each	1
IB-21-LE	Lid for IB-21		Each	6
IB-27-LE	Lid for IB-27		Each	6

ITEM #	WEIGHT SUGAR	WEIGHT FLOUR
IB-21	159 lbs	124 lbs
IB-27	197 lbs	154 lbs



3" Caster Wheels with Brakes



Convenient Scoop Storage

**INGREDIENT BINS**



IB-21



IB-27

IB-SERIES



**POLYPROPYLENE SHELF INGREDIENT BINS**

- ◆ Stackable for more storage space
- ◆ One-handed lift lid design to increase efficiency
- ◆ Clear plastic polycarbonate front lid to quickly identify ingredients
- ◆ Scoop with dedicated clip to ensure sanitation compliance
- ◆ NSF listed

ITEM	DESCRIPTION	SIZE	UOM	CASE
IB-2S	2 Gallon, 40 Cup	11-3/4" x 14-1/4" x 8-3/8"	Each	1
IB-5S	5 Gallon, 80 Cup	11-1/8" x 23-3/8" x 16-7/8"	Each	1
IB-10S	10 Gallon, 150 Cup	19-1/4" x 23-3/8" x 16-7/8"	Each	1

**SHELF INGREDIENT BINS**



IB-10S



IB-5S



IB-2S

IB-SERIES



## FOOD STORAGE CONTAINERS



FCW-32 & FCW-32RC

FCW-32L  
24-3/8" Dia

**NSF** FCW-SERIES

## POLYETHYLENE FOOD STORAGE CONTAINERS

◆ Lids sold separately, NSF listed

ITEM	DESCRIPTION	UOM	CASE
FCW-10	Container, 10 Gal	Each	1/6
FCW-20*	Container, 20 Gal	Each	1/6
FCW-32*	Container, 32 Gal	Each	1/6
FCW-10L	PP Lid for FCW-10	Each	1/24
FCW-20L	PP Lid for FCW-20	Each	1/12
FCW-32L	PP Lid for FCW-32	Each	1/12
FCW-10RC	PC Rotating Lid for FCW-10	Each	1/6
FCW-20RC	PC Rotating Lid for FCW-20	Each	1/6
FCW-32RC	PC Rotating Lid for FCW-32	Each	1/6

\*Fits DLR-series dollies (see p.247)

ITEM #	CAPACITY (GALLONS)	CAPACITY (CUPS)	FLOUR (LBS)	SUGAR (LBS)
FCW-10	10	150	47	65
FCW-20	20	300	94	130
FCW-32	32	500	156	217

## DELI CROCKS & COVERS



CRK-SERIES

CRKC-13

CRKC-10

**BPA FREE** CRK-SERIES

## DELI CROCKS & COVERS

*The beautiful fluted-finish, combined with durable SAN plastic makes these crocks ideal for deli counter and picnic buffet presentations.*

◆ BPA-free

ITEM	DESCRIPTION	COLOR	UOM	CASE
CRK-10R	10" x 7" x 3"	Red	Each	24
CRK-10K	10" x 7" x 3"	Black	Each	24
CRK-10C	10" x 7" x 3"	Clear	Each	24
CRK-10W	10" x 7" x 3"	White	Each	24
CRK-13R	13" x 10" x 3"	Red	Each	12
CRK-13K	13" x 10" x 3"	Black	Each	12
CRK-13C	13" x 10" x 3"	Clear	Each	12
CRK-13W	13" x 10" x 3"	White	Each	12
CRKC-10	Cover for CRK-10 Series	Clear	Each	48
CRKC-13	Cover for CRK-13 Series	Clear	Each	48

## BEVERAGE DISPENSER



PBDW-22

**BPA FREE** PBDW-SERIES

## POLYPROPYLENE BEVERAGE CONTAINER/DISPENSER

*This container dispenser comes with a secure fit snap-on lid and handle for easy transport.*

- ◆ Leak-proof faucet and snap-on lid
- ◆ Bail-style handle with comfortable handgrip
- ◆ Red graduations in liters and quarts
- ◆ Temperature range from -40°F to 160°F
- ◆ Dishwasher safe

ITEM	DESCRIPTION	UOM	CASE
PBDW-22	6 Gal, PP	Each	1/4
PBDW-FS	Faucet for PBDW-22	Each	1

**DOUGH BOXES & COVER**

- ◆ Boxes stack tight to maintain freshness of contents
- ◆ Great for storing and proofing dough
- ◆ Reinforced structure resists breakage/bending over time
- ◆ Made of durable polypropylene
- ◆ BPA-free

ITEM	DESCRIPTION	UOM	CASE
PL-3N	25-5/8"L x 18"W x 3-1/4"H	Each	6
PL-6N	25-1/2"L x 17-1/2"W x 6"H	Each	3
PL-36NC	Cover	Each	12

Replaces PL-3, PL-6, PL-36C

**DOUGH BOXES**



**IMPROVED STRUCTURE**



Stackable

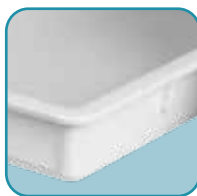

Reinforced edges & corners

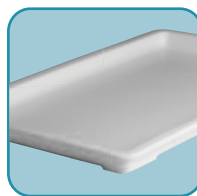

Lid can be used as tray



Seamless fit for fresh storage

**NSF**

PL-SERIES

**BPA FREE**

**WIRE DOUGH BOX DOLLY**

Transport multiple dough boxes with ease using this wire dolly, currently the only one on the market!

- ◆ Capacity up to 400 Lbs
- ◆ Winco® exclusive
- ◆ Casters measure 3-3/4" Dia each

ITEM	DESCRIPTION	UOM	CASE
DWR-2617	27"L x 18-1/4"W x 2-1/2"H	Each	1

**WIRE DOUGH BOX DOLLY**



Transport dough boxes



DWR-2617



SHEET PANS



ALXP-0609



ALXP-2216H



Closed bead



NSF ALXP-1200



Open bead



ALXP-1318P



WINCO's "dense" perforation vs. others

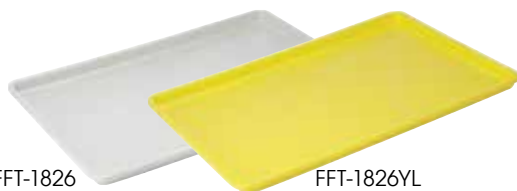

FFT-1826

FFT-1826YL

NSF FFT-SERIES



ALUMINUM SHEET PANS

Whether they are reinforced with galvanized wire or extra heavy-duty open bead, Winco® sheet pans can be counted on to hold their shape in high oven temperatures during baking, roasting or broiling.

- ◆ Closed bead with galvanized wire for rust resistance and reinforcement
- ◆ Made of 3003 aluminum
- ◆ Heavy-duty open bead pans also useful as roasting pans
- ◆ ALXP-1200 is NSF listed

ITEM	DESCRIPTION	SIZE	GAUGE	UOM	CASE
ALXP-0609	1/8-Size Open Bead	6" x 9"	16	Each	24
ALXP-1013	1/4-Size Closed Bead	9-1/2" x 13"	20	Each	24
ALXP-1310H	1/4-Size Closed Bead	10" x 13"	18	Each	24
ALXP-1318	1/2-Size Closed Bead	13" x 18"	20	Each	12
ALXP-1813H	1/2-Size Closed Bead	13" x 18"	18	Each	12
ALXP-1622	2/3-Size Closed Bead	16" x 22"	19	Each	12
ALXP-2216H	2/3-Size Closed Bead	16" x 22"	18	Each	12
ALXP-1826	Full-Size Closed Bead	18" x 26"	18	Each	12
ALXP-2618H	Full-Size Closed Bead	18" x 26"	16	Each	12
ALXP-1200	Full-Size Open Bead, NSF	18" x 26"	12	Each	12

ALUMINUM SHEET PANS - PERFORATED (CLOSED BEAD)

The denser hole perforations on these sheet pans allow for better air circulation and heat conductivity, typically preferred by bakers for a crispier outcome.

- ◆ Perforated holes are 1/8" diameter
- ◆ Made of 3003 aluminum

ITEM	DESCRIPTION	SIZE	GAUGE	UOM	CASE
ALXP-1318P	1/2-Size	13" x 18"	18	Each	12
ALXP-1826P	Full-Size	18" x 26"	18	Each	12
ALXP-2618P	Full-Size	18" x 26"	16	Each	12

PLASTIC SHEET TRAYS

- ◆ Can also be used as a plastic sheet pan
- ◆ NSF listed

ITEM	DESCRIPTION	COLOR	UOM	CASE
FFT-1826	18" x 26"	White	Each	12
FFT-1826YL	18" x 26"	Yellow	Each	6

### SHEET PAN COVERS

- ◆ Protects food products during transport or storage
- ◆ Excellent reusable alternative to film or foil
- ◆ Easily snaps onto most aluminum sheet pans in full or half-sizes
- ◆ Polypropylene plastic; Dishwasher safe
- ◆ NSF listed; BPA-free

ITEM	DESCRIPTION	SIZE	UOM	CASE
CXP-1826	Full-Size	18" x 26"	Each	24
CXP-1318	Half-Size	13" x 18"	Each	24
CXP-1013	Quarter-size	10" x 13"	Each	24



### SHEET PAN EXTENDERS

- ◆ Great for making sheet cakes without using a cake pan
- ◆ Flat top edges for easy gripping
- ◆ Flat top of extender also allows sheet pans to be stacked while baked goods cool
- ◆ 2" height
- ◆ Hand wash only
- ◆ Aluminum

ITEM	DESCRIPTION	SIZE	UOM	CASE
AXPE-1	Full-Size	18" x 26"	Each	12
AXPE-2	Half-Size	13" x 18"	Each	12
AXPE-4	Quarter-Size	9-1/2" x 13"	Each	12

### SHEET PAN ACCESSORIES



(sheet pan not included)

NEW SIZE

CXP-SERIES

NSF

BPA FREE



Make sheet cakes without cake pan



AXPE-2

### STAINLESS STEEL WIRE SHEET PAN GRATES

- ◆ Footed to elevate food to keep from sticking to sheet pan
- ◆ Can also be used as a cooling or icing rack

ITEM	DESCRIPTION	SHEET PAN SIZE	UOM	CASE
PGWS-2416	For Full-Size	16" x 24"	Each	12/24
PGWS-1216	For Half-Size	12" x 16-1/2"	Each	12/48

### SHEET PAN GRATES



PGWS-1216



Raised Feet



PGW-1420

SEE PAGE 189 FOR STEAM PAN GRATES

### CHROME-PLATED WIRE SHEET PAN GRATE

ITEM	DESCRIPTION	SHEET PAN SIZE	UOM	CASE
PGW-2416	For Full-Size	16" x 24"	Each	12/24
PGW-1420	For 2/3-Size	14" x 20"	Each	12/24
PGW-1216	For Half-Size	12" x 16-1/2"	Each	12/48



### ALLERGEN-FREE PURPLE SILICONE BAKING MATS

Whether it's gluten or nuts, use this stand-out purple color to designate these mats Allergen-Free.

- ◆ Double-sided and reusable up to 2,000 times
- ◆ Provides consistent and even heat distribution
- ◆ Woven fiberglass coated with food grade silicone
- ◆ Temperature tolerance from -40°F to 480°F

ITEM	DESCRIPTION	SIZE	UOM	CASE
SBS-11PP	1/4-Size	8-1/4" x 11-3/4"	Each	20/100
SBS-16PP	1/2-Size	11-5/8" x 16-1/2"	Each	10/50
SBS-21PP	2/3-Size	14-7/16" x 20-1/2"	Each	10/50
SBS-24PP	Full-Size	16-3/8" x 24-1/2"	Each	10/50

### SILICONE BAKING MATS



SBS-21PP

SEE PAGE 251 FOR MORE OF THE ALLERGEN-FREE LINE

Allergen Free



### RECTANGULAR SILICONE BAKING MATS

- ◆ Reusable up to 2,000 times, use both sides
- ◆ Provides consistent even heat distribution
- ◆ Woven fiberglass coated with food grade silicone
- ◆ Temperature tolerance from -40°F to 480°F

ITEM	DESCRIPTION	SIZE	UOM	CASE
SBS-11	1/4-Size	8-1/4" x 11-3/4"	Each	20/100
SBS-16	1/2-Size	11-5/8" x 16-1/2"	Each	10/50
SBS-21	2/3-Size	14-7/16" x 20-1/2"	Each	10/50
SBS-24	Full-Size	16-3/8" x 24-1/2"	Each	10/50



SBS-SERIES



# ALUMINUM SHEET PAN & BUN RACKS



Winco's exclusive Weld<sup>2</sup> System features fail-safe rigidity through both bolting and welding at all critical joints to prevent warping with long term, high-traffic use

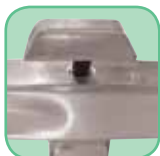

Specialty bolts secure each joint



Bolt caps are welded over completely to form extra-strength juncture

**NSF** AWRK-20  
\*10 Tier Available

Made for the most demanding restaurant kitchens, these aluminum sheet pan racks accommodate standard full-size 18" x 26" sheet/bun pans, or twice the capacity with half-size 18" x 13" pans. All racks are shipped knocked down and require assembly except for the welded series.

## WELDED SHEET PAN RACKS

- ◆ Featuring Winco's exclusive Weld<sup>2</sup> Dual Weldment System
- ◆ Heavy-duty caster wheels handle loads up to 650 lbs
- ◆ NSF listed

ITEM	DESCRIPTION	UOM	CASE
AWRK-10	10-Tier, 3" Spacing	Each	1
AWRK-20	20-Tier, 3" Spacing	Each	1

## SHEET PAN RACKS WITH BRAKES

- ◆ Ships knocked down
- ◆ NSF listed

ITEM	DESCRIPTION	UOM	CASE
ALRK-10BK	10-Tier, 3" Spacing	Each	1
ALRK-20BK	20-Tier, 3" Spacing	Each	1
ALRK-30BK	30-Tier, 2" Spacing (with heavyweight casters)	Set	1

## SHEET PAN RACKS

- ◆ Ships knocked down
- ◆ NSF listed

ITEM	DESCRIPTION	UOM	CASE
ALRK-10	10-Tier w/o Brake	Each	1
ALRK-20	20-Tier w/o Brake	Each	1



**NSF** ALRK-10BK   **NSF** ALRK-20BK   **NSF** ALRK-30BK

## SHEET PAN RACK ACCESSORIES

ITEM	DESCRIPTION	UOM	CASE
ALRK-10-CV	Cover for 10-Tier Rack	Each	1/12
ALRK-20-CV	Cover for 20- and 30-Tier Racks	Each	1/12
ALRC-5ST	Caster for ALRK and AWRK-series	Each	12
ALRC-5STK	Caster w/Brake for ALRK & AWRK-series	Each	12
ALRC-5H	Caster for ALRK-30BK, Heavyweight	Each	12
ALRC-5HK	Caster w/Brake for ALRK-30BK, Heavyweight	Each	12

## REPLACEMENT CASTERS FOR SHEET PAN RACKS

ITEM	ALRK-3	ALRK-15	ALRK-10	ALRK-20	ALRK-10BK	ALRK-20BK	ALRK-30BK	AWRK-10	AWRK-20
ALRC-5P	4								
ALRC-5ST		2	4	4	2	2		4	2
ALRC-5STK		2			2	2			2
ALRC-5H							2		
ALRC-5HK							2		



**NSF** ALRK-10   **NSF** ALRK-20



ALRK-10-CV



ALRK-20-CV



ALRC-5STK  
5" caster  
with brake

### 20-TIER NESTING RACK WITH BRAKES

Designed with space-saving in mind, the Z-rack fits snugly with nesting racks to conserve floor space while in storage. The Z-rack accommodates standard full-size sheet pans, or twice the capacity with half-size pans.

- ◆ Z-frame nesting design for compact storage
- ◆ Sturdy aluminum structure
- ◆ Capacity: up to 650 lbs & 20 full-size (18" x 26") sheet pans
- ◆ Full-swivel casters; two (2) with brake
- ◆ 3" spacing between each tier
- ◆ Fully assembled: 22" L x 27-1/2"W x 70"H
- ◆ NSF listed

ITEM	DESCRIPTION	SIZE	UOM	CASE
ALZK-20BK	20-Tier, Knocked Down	22"L x 27-1/2"W x 70"H	Each	1
AWZK-20	20-Tier, Welded	22"L x 27-1/2"W x 70"H	Each	1



ALRC-5STK  
5" caster  
with brake

### ALUMINUM SHEET PAN & BUN RACKS



ALZK-20BK



AVAILABLE  
EITHER  
KNOCKED DOWN  
OR WELDED

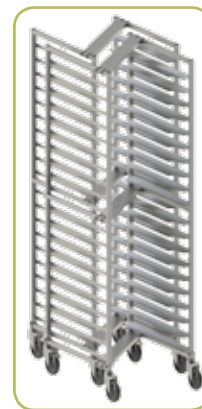

ALZK-20BK  
AWZK-20 NSF

### COUNTER-HEIGHT SHEET PAN RACK

- ◆ Rack has slides and a hard top that can be used as cutting board stand
- ◆ 14 gauge 6063 aluminum with 1" extruded tube frame
- ◆ Full swivel casters, 5" diameter x 1-1/4"
- ◆ Capacity fits 15 full-size (18" x 26") or 30 half-size (18" x 13") sheet pans (not included)
- ◆ Capacity up to 200 lbs
- ◆ Ships knocked down
- ◆ NSF listed

ITEM	DESCRIPTION	SIZE	UOM	CASE
ALRK-15	15-Tier	26-1/8"L x 20-7/8"W x 31-5/8"H	Set	1



ALRK-15 NSF

### SHEET PAN TRUCK

- ◆ 14 gauge 6063 aluminum with 1" extruded aluminum tube frame
- ◆ Full swivel casters, 5" diameter x 1-1/4" width
- ◆ Capacity is 54 full-size (18" x 26") or 108 half-size (13" x 18") sheet pans (not included)
- ◆ Ships knocked down
- ◆ NSF listed

ITEM	DESCRIPTION	SIZE	UOM	CASE
ALRK-3	Sheet Pan Truck	28-7/8"L x 20-5/8"W x 33-3/8"H	Set	1
ALRC-5P	Replacement Caster for ALRK-3		Each	12



ALRK-3

ALRK-SERIES NSF



## RECTANGULAR CAKE PANS



HSCP-0808

HRCP-1812



ACP-0913

ACP-1212



HLF-100

PFOA FREE HLF-SERIES



## ALUMINIZED STEEL CAKE PANS

- ◆ Quantum2® non-stick coating (double-coated)
- ◆ Withstands temperatures to 500°F (260°C)
- ◆ 24 gauge non-stick aluminized steel
- ◆ Wire-in reinforced rim with folded body construction
- ◆ PTFE/PFOA-free
- ◆ Dishwasher safe

ITEM	DESCRIPTION	SIZE	UOM	CASE
HRCP-1309	Rectangular	13" x 9" x 2-1/4"	Each	6
HRCP-1812	Rectangular	18" x 12" x 3"	Each	6
HSCP-0808	Square	8" x 8" x 2-1/4"	Each	6



## ALUMINUM CAKE PANS

- ◆ Straight sided, perfect for commercial baking
- ◆ Extended 1/2" flange for easy and safe handling
- ◆ Heavyweight for even heat distribution
- ◆ 1.6mm thickness, 16 gauge

ITEM	DESCRIPTION	SIZE	UOM	CASE
ACP-0913	Rectangular	9" x 13" x 2"	Each	6
ACP-1212	Square	12" x 12" x 2"	Each	6



## ALUMINIZED STEEL LOAF PANS

- ◆ Quantum2® non-stick coating (double-coated)
- ◆ Withstands temperatures up to 500°F (260°C)
- ◆ 24 gauge non-stick aluminized steel
- ◆ Wire-in reinforced rim with folded body construction
- ◆ PTFE/PFOA-free
- ◆ Dishwasher safe

ITEM	DESCRIPTION	SIZE	UOM	CASE
HLF-100	1 lb Loaf	8-1/2" x 4-1/2" x 2-3/4"	Each	6
HLF-150	1-1/2 lb Loaf	10" x 5" x 3"	Each	6

## SHEET CAKE MARKERS

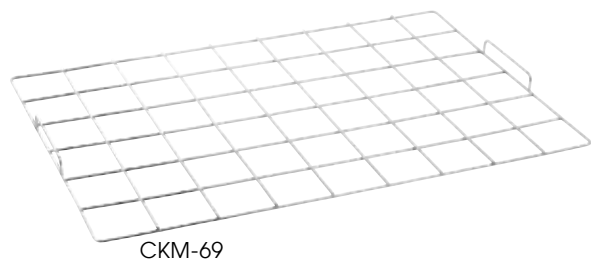

CKM-69



## SHEET CAKE MARKERS

*A must-have for bakeries and buffets to achieve consistently sized square cuts.*

- ◆ Stainless steel
- ◆ Full-size: 24-3/4"L x 16-3/4"W x 1"H

ITEM	DESCRIPTION	UOM	CASE
CKM-68	6 x 8, Marks (48) 3" x 3" Pieces	Each	1/24
CKM-69	6 x 9, Marks (56) 2-1/2" x 2-1/2" Pieces	Each	1/24
CKM-610	6 x 10, Marks (60) 2-1/4" x 2-1/2" Pieces	Each	1/24

### ALUMINUM BAGUETTE PANS

Serve up warm and fresh long rolls with the sturdy, commercial-grade baguette pans by Winco®. Each compartment cradles a baguette - up to six with the largest size pan - and the perforations allow air circulation for crispy crusts while the inside stays soft.

- ◆ 3003 Aluminum
- ◆ Non-stick coating for easy release
- ◆ Heat circulates through the perforations while cooking, resulting in crispy crusts while bread inside stays soft
- ◆ Commercial-grade quality
- ◆ All pans are 18" x 26"; variety of slot options
- ◆ PTFE/PFOA-free

ITEM	DESCRIPTION	UOM	CASE
ABP-4L	4 Slots	Each	6
ABP-5L	5 Slots	Each	6
ABP-5W	5 Slots, Wide	Each	6
ABP-6L	6 Slots	Each	6

### ALUMINUM BAGUETTE PANS

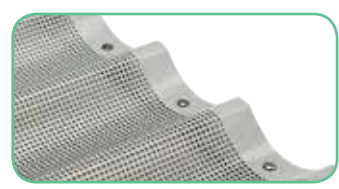

Perforations



**NEW**

ABP-6L

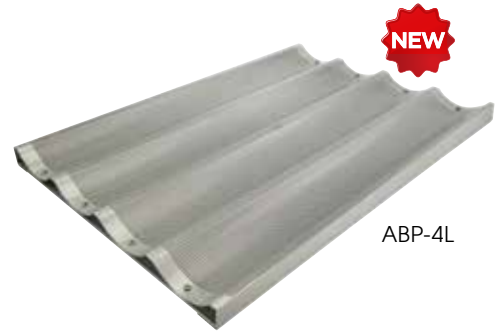

**NEW**

ABP-4L



**NEW**

ABP-5W



**NEW**

ABP-5L

ABP-SERIES **PFOA FREE**

### SILICONE BREAD FORM

- ◆ Non-stick silicone surface requires no oils or sprays
- ◆ Heats quickly and bakes evenly
- ◆ Ideal size for 12" long sandwich bread
- ◆ Dishwasher, oven, microwave and freezer safe
- ◆ Heat resistant up to 425°F (218°C)

ITEM	DESCRIPTION	SIZE	UOM	CASE
SBF-5K	5 Roll	18" x 13"	Each	12/144

### BREAD FORM



SBF-5K

## SPRINGFORM PANS



HSP-123

PFOA FREE

HSP-SERIES



AASP-093



CPSF-9



### ALUMINIZED STEEL SPRINGFORM PANS

- ◆ Quantum2® non-stick coating (double-coated)
- ◆ Withstands temperatures up to 500°F (260°C)
- ◆ 24 gauge
- ◆ Dishwasher safe
- ◆ PTFE/PFOA-free

ITEM	DESCRIPTION	UOM	CASE
HSP-063	6"Dia x 2-3/4"H	Set	1/6
HSP-083	8"Dia x 2-3/4"H	Set	1/6
HSP-093	9"Dia x 2-3/4"H	Set	1/6
HSP-103	10"Dia x 2-3/4"H	Set	1/6
HSP-123	12"Dia x 2-3/4"H	Set	1/6



### ANODIZED ALUMINUM SPRINGFORM PANS

- ◆ Durable, non-stick, bakes evenly and releases cleanly
- ◆ Oven safe up to 450°F (232°C)
- ◆ Hand wash recommended

ITEM	DESCRIPTION	UOM	CASE
AASP-063	6"Dia x 3"H	Each	1/36
AASP-093	9"Dia x 3"H	Each	1/24

### TIN SPRINGFORM PANS

ITEM	DESCRIPTION	UOM	CASE
CPSF-8	8"Dia x 3"H	Each	12/36
CPSF-9	9-1/2"Dia x 3"H	Each	12/24
CPSF-10	10"Dia x 3"H	Each	12/24

## SPECIALTY CAKE PANS

PFOA FREE



CCP-10F



PFOA FREE



CCP-10A

PFOA FREE



NACP-10



NTHM-8



### FLUTED CAKE PAN

- ◆ Quantum2® non-stick aluminized carbon steel
- ◆ Ideal for making bundt cakes
- ◆ Dishwasher safe
- ◆ PTFE/PFOA-free

ITEM	DESCRIPTION	UOM	CASE
CCP-10F	10"Dia x 3-1/4"H	Each	1/6



### ANGEL FOOD CAKE PANS

- ◆ Quantum2® non-stick coating
- ◆ Dishwasher safe
- ◆ PTFE/PFOA-free

ITEM	DESCRIPTION	UOM	CASE
CCP-10A	10"Dia x 5"H Removable Bottom, Aluminized Carbon Steel	Each	1/6
NACP-10	10"Dia x 4"H Carbon Steel	Each	12/24



### TURK HEAD MOLD

- ◆ Non-stick carbon steel

ITEM	DESCRIPTION	UOM	CASE
NTHM-8	8-1/2"Dia x 4"H	Each	12/24

## DELUXE HARD ANODIZED ALUMINUM CAKE PANS

- ◆ 1.0mm thickness, 18 gauge

ITEM	DESCRIPTION	UOM	CASE
HAC-042	4"Dia x 2"H	Each	6/24
HAC-062	6"Dia x 2"H	Each	6/24
HAC-082	8"Dia x 2"H	Each	6/24
HAC-102	10"Dia x 2"H	Each	6/24
HAC-122	12"Dia x 2"H	Each	6/24
HAC-142	14"Dia x 2"H	Each	6/24
HAC-162	16"Dia x 2"H	Each	6/12

## ALUMINUM LAYER-CAKE PANS

ITEM	DESCRIPTION	UOM	CASE
ACP-062	6"Dia x 2"H	Each	6/36
ACP-082	8"Dia x 2"H	Each	6/36
ACP-083	8"Dia x 3"H	Each	6/36
ACP-092	9"Dia x 2"H	Each	6/36
ACP-093	9"Dia x 3"H	Each	6/36
ACP-102	10"Dia x 2"H	Each	6/36
ACP-103	10"Dia x 3"H	Each	6/36
ACP-122	12"Dia x 2"H	Each	6/36
ACP-123	12"Dia x 3"H	Each	6/24

## ALUMINUM PIE PLATES

ITEM	DESCRIPTION	UOM	CASE
APPL-8	8"Dia	Each	12/72
APPL-9	9"Dia	Each	12/72
APPL-10	10"Dia	Each	12/72
APPL-11	11"Dia	Each	12/72

## QUICHE/TART PANS

- ◆ Removable bottom eliminates damaging the crust by allowing for easy extraction of delicate molds
- ◆ Dishwasher safe

ITEM	DESCRIPTION	UOM	CASE
FQP-4	4"Dia x 3/4"H, 2-Pcs/Set	Set	1/6
FQP-8	8"Dia x 1-1/2"H	Each	1/6
FQP-10	10"Dia x 1-1/4"H	Each	1/6
FQP-12	12"Dia x 1-3/8"H	Each	1/6

## CAST ALUMINUM PIE/CAKE MARKERS

ITEM	DESCRIPTION	UOM	CASE
APM-06	6-Cut	Each	12/48
APM-07	7-Cut	Each	12/48
APM-08	8-Cut	Each	12/48
APM-10	10-Cut	Each	12/48
APM-12	12-Cut	Each	12/48

## STAINLESS STEEL PIE CUTTERS

ITEM	DESCRIPTION	UOM	CASE
SCU-6	6-Cut	Each	6/12
SCU-7	7-Cut	Each	6/12
SCU-8	8-Cut	Each	6/12

## DOUBLE-SIDED CAKE MARKERS

- ◆ Scores cakes up to 10" round for even slices
- ◆ Food grade polypropylene plastic

ITEM	DESCRIPTION	UOM	CASE
PCM-1012	10 & 12 Slice Marks	Each	12/24
PCM-1416	14 & 16 Slice Marks	Each	12/24

## WIRE CAKE LEVELER

*This essential baker's tool is a must-have for making beautiful, thinly layered cakes and tortes.*

- ◆ Adjustable stainless steel cutting wire with 10 notches
- ◆ Accommodates 10" diameter cakes that are 2" high

ITEM	DESCRIPTION	UOM	CASE
WLC-12	12" Bow	Each	24/144

## ROUND CAKE PANS



HAC-042

HAC-062



ACP-062



APPL-11



APPL-8



FQP-10

## MARKERS & CUTTERS



APM-10



SCU-6



PCM-1012

PCM-SERIES

BPA FREE



WLC-12



## MINI LOAF PAN

NEW



PFOA FREE

HLF-8MN



## MINI LOAF PAN

Increase production and bake eight mini loaves, lasagnas or pastries at once! The essential, durable mini loaf pan is non-stick for easy release and even easier cleanup. Perfect for breads, mini meat loaves, lasagnas, quiche and pastries.

- ◆ Heavy-duty carbon steel with premium non-stick coating
- ◆ Makes eight (8) mini loaves
- ◆ Withstands temperatures up to 410°F (210°C)
- ◆ Dishwasher safe
- ◆ PTFE/PFOA-free

ITEM	DESCRIPTION	SIZE	CAPACITY	UOM	CASE
HLF-8MN	8 Cup	14" x 10-5/8"	5 Oz	Each	6



## MUFFIN PANS



AMF-24NS



AMF-12NS



AMF-6NS

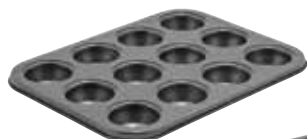

CMF-12M

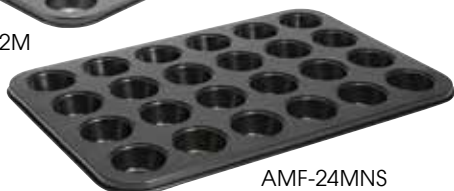

AMF-24MNS

## REGULAR MUFFIN PANS

ITEM	DESCRIPTION	SIZE	CAPACITY	UOM	CASE
AMF-12	12 Cup, Alu	14" x 11"	3 Oz	Each	12/24
AMF-24	24 Cup, Alu	20-1/2" x 14"	3 Oz	Each	12
AMF-12NS	12 Cup, Non-stick Carbon Steel	15-1/2" x 11"	3 Oz	Each	24
AMF-24NS	24 Cup, Non-stick Heavy Alu	20-1/2" x 14"	3 Oz	Each	12



AMF-24



AMF-12

## JUMBO MUFFIN PAN

- ◆ Non-stick carbon steel

ITEM	DESCRIPTION	SIZE	CAPACITY	UOM	CASE
AMF-6NS	6 Cup	13" x 8-1/2"	7 Oz	Each	24

## MINI MUFFIN PANS

- ◆ Non-stick carbon steel



ITEM	DESCRIPTION	SIZE	CAPACITY	UOM	CASE
CMF-12M	12 Cup	10" x 7-3/4"	3/4 Oz	Each	1/6
AMF-24MNS	24 Cup	13-3/4" x 10-1/2"	1-1/2 Oz	Each	12



### COOKIE SHEET

- ◆ Deluxe hard anodized aluminum
- ◆ Durable, non-stick and bakes evenly
- ◆ Withstands temperatures up to 450°F (232°C)
- ◆ Hand wash recommended

ITEM	DESCRIPTION	SIZE	UOM	CASE
CS-2014	15 Gauge	20" x 14"	Each	4/16



### COOKIE SHEET



CS-2014

### ICING/COOLING RACK

- ◆ Built-in feet

ITEM	DESCRIPTION	SIZE	UOM	CASE
ICR-1725	Rectangular	16-1/4" x 25"	Each	6/12

### COOLING RACKS



ICR-1725

### STEAMER RACKS

- ◆ Built-in feet

ITEM	DESCRIPTION	SIZE	UOM	CASE
STR-10	Round	10-3/7"	Each	10
STR-13	Round	12-3/4"	Each	10
STR-15	Round	14-3/4"	Each	10
STR-18	Round	17-3/4"	Each	10



STR-15

### DOUGHNUT BASKET

- ◆ Nickel-plated

ITEM	DESCRIPTION	UOM	CASE
DB-1218	12"L x 18"W x 2"H	Each	24

### DOUGHNUT BASKET



DB-1218



## CAKE DECORATING



CKSR-12



NSF CKS-13C



CKS-13



NSF SDC-6



### REVOLVING CAKE DECORATING STAND

- ◆ Made of aluminum alloy with a smooth ball-bearing mechanism
- ◆ Cast iron base with silicone bottom for steady grip

ITEM	DESCRIPTION	UOM	CASE
CKSR-12	12"Dia	Each	6

### CAKE STAND & COVER

- ◆ Assembly required for cake stand and cover
- ◆ Covers available for full case purchase only

ITEM	DESCRIPTION	SIZE	UOM	CASE
CKS-13	Cake Stand, S/S	13" Dia	Each	6/12
CKS-13C	Cover for CKS-13, Plastic, NSF	12" Dia	Each	6



### STAINLESS STEEL TRIANGLE DECORATING COMBS

- ◆ 1.0mm thickness
- ◆ 3 different jagged teeth edges on each piece
- ◆ Each pack contains six (6) pieces
- ◆ NSF Listed

ITEM	DESCRIPTION	UOM	CASE
SDC-6	Fine, Medium, and Coarse in One Piece	Pack	12/48

## SPATULAS



TWPO-7

TWPS-7

NSF TWPO & TWPS-SERIES



TKPO-7

TKPS-7

NSF TKPO & TKPS-SERIES



TOS-7

TNS-7

- ◆ Stainless steel
- ◆ Satin finish
- ◆ NSF listed



### WHITE ERGO HANDLE

- ◆ Dishwasher safe

ITEM	DESCRIPTION	BLADE	UOM	CASE
TWPO-4	Offset Spatula*	3-1/2" x 3/4"	Each	24/288
TWPO-7	Offset Spatula*	6-1/2" x 1-5/16"	Each	12/144
TWPO-9	Offset Spatula*	8-1/2" x 1-1/2"	Each	12/144
TWPS-4	Bakery Spatula	4" x 3/4"	Each	24/288
TWPS-7	Bakery Spatula	7-15/16" x 1-1/4"	Each	12/144
TWPS-9	Bakery Spatula	10" x 1-3/8"	Each	12/72

\*Measurement reflects blade size not including offset



### BLACK ERGO HANDLE

- ◆ Dishwasher safe

ITEM	DESCRIPTION	BLADE	UOM	CASE
TKPO-4	Offset Spatula*	3-1/2" x 3/4"	Each	24/288
TKPO-7	Offset Spatula*	6-1/2" x 1-5/16"	Each	12/144
TKPO-9	Offset Spatula*	8-1/2" x 1-1/2"	Each	12/144
TKPS-4	Bakery Spatula	4" x 3/4"	Each	24/288
TKPS-7	Bakery Spatula	7-15/16" x 1-1/4"	Each	12/144
TKPS-9	Bakery Spatula	10" x 1-3/8"	Each	12/144

\*Measurement reflects blade size not including offset

### WOODEN HANDLE SPATULAS

ITEM	DESCRIPTION	BLADE	UOM	CASE
TNS-4	Bakery Spatula	4" x 3/4"	Each	24/288
TNS-7	Bakery Spatula	7-15/16" x 1-1/4"	Each	12/144
TNS-9	Bakery Spatula	10" x 1-3/8"	Each	12/72
TOS-4	Spatula Offset	3-1/2" x 3/4"	Each	24/288
TOS-7	Spatula Offset	6-1/2" x 1-5/16"	Each	12/144
TOS-9	Spatula Offset	8-1/2" x 1-1/2"	Each	12/72

\*Measurement reflects blade size not including offset

### CAKE DECORATING TIP SETS

Create delicate and pretty confections with these decorating tips made of rust-resistant stainless steel. Decorating tip sets come in a convenient storage box. The 26 and 52 piece sets include a standard coupler and metal flower nail.

ITEM	DESCRIPTION	UOM	CASE
CDT-24	24-Pc Set	Set	60
CDT-26	26-Pc Set	Set	12/48
CDT-52	52-Pc Set	Set	6/24



Convenient storage tray



CDT-24



CDT-26



CDT-52

### DECORATING TIP SETS



### CANVAS PASTRY BAG

◆ Polyurethane plastic-coated interior

ITEM	DESCRIPTION	UOM	CASE
PBC-12	12"	Each	12/576
PBC-14	14"	Each	12/576
PBC-16	16"	Each	12/576
PBC-18	18"	Each	12/576
PBC-21	21"	Each	12/576
PBC-24	24"	Each	12/288

### PASTRY BAGS



PBC-16



CDTC-2

### PLASTIC COUPLINGS

ITEM	DESCRIPTION	UOM	CASE
CDTC-2	2-Pc Set	Set	12/360





# COOKIE & PASTRY CUTTERS

Create sweet, delicate confections with these cookie and pastry cutters made of rust-resistant stainless steel. Available in assorted shapes and sizes.



CST-1



CST-2



CST-12



CST-22



## COOKIE CUTTERS

ITEM	DESCRIPTION	SHAPE	UOM	CASE
CST-1	11-Pc Set	Fluted Round	Set	12/48
CST-2	11-Pc Set	Plain Round	Set	12/48
CST-12	11-Pc Set, 2"H	Fluted Round	Set	1/24
CST-22	11-Pc Set, 2"H	Plain Round	Set	1/24



## PASTRY CUTTERS

ITEM	DESCRIPTION	SHAPE	UOM	CASE
CST-31	8-pc Pastry Set	Butterflies	Set	12/60
CST-32	12-pc Pastry Set	Shapes	Set	12/60
CST-33	6-pc Pastry Set	Holiday	Set	12/60
CST-34	26-pc Pastry Set	Letters	Set	12/48



CST-31



CST-32



CST-33



CST-34



CC-1



CC-2

## DEEP COOKIE CUTTER

- ◆ Ideal for cutting dough for biscuits
- ◆ 2-1/2" deep cut

ITEM	DESCRIPTION	UOM	CASE
CC-1	3"Dia, S/S	Each	12/120

## DOUGHNUT CUTTER

- ◆ 2-1/2" deep cut

ITEM	DESCRIPTION	UOM	CASE
CC-2	3"Dia, S/S	Each	12/120

**CULINARY PASTRY MOLDS**

Perfect for baking, freezing, cutting and forming, these ring molds are extremely versatile kitchen tools. Create attractive plate presentations by layering salads and grains, or bake individual cake and pastry portions without waste.

- ◆ Stainless steel
- ◆ Polished smooth to a brilliant mirror finish
- ◆ Dishwasher safe

ITEM	DESCRIPTION	UOM	CASE
SPM-21R	Round, 2"Dia x 1-3/4"H	Each	12/72
SPM-23R	Round, 2"Dia x 3"H	Each	12/72
SPM-31R	Round, 3"Dia x 1-3/4"H	Each	12/72
SPM-31O	Oval, 3"L x 1-3/8"H	Each	12/72
SPM-41O	Oval, 4"L x 1-3/8"H	Each	12/72
SPM-22S	Square, 2"L x 2"W x 2"H	Each	12/72
SPM-275S	Square, 2-3/4"L x 2-3/4"W x 1-3/4"H	Each	12/72
SPM-211T	Rectangular, 2-1/2"L x 1-3/4"W x 1-3/4"H	Each	12/72



**PASTRY MOLDS**



## DOUGH PREPARATION



ALDP-SERIES

## DOUGH RETARDING/PROOFING PANS & COVERS

- ◆ Stackable for easy storage
- ◆ Aluminum

ITEM	DESCRIPTION	UOM	CASE
ALDP-48	48 Oz, 7-7/8"Dia x 3"H	Each	12/24
ALDP-48C	Cover for ALDP-48	Each	120
ALDP-96	96 Oz, 8-3/4"Dia x 3"H	Each	12/24
ALDP-96C	Cover for ALDP-96	Each	120

## DOUGH BOXES & COVER



PL-36NC

IMPROVED STRUCTURE

PL-3N

PL-6N

NSF

BPA FREE

PL-SERIES

SEE PAGE 199 FOR DOUGH BOX DOLLY

## DOUGH BOXES & COVER

- ◆ Boxes stack tight to maintain freshness of contents
- ◆ Great for storing and proofing dough
- ◆ Reinforced structure resists breakage/bending over time
- ◆ Made of durable polypropylene
- ◆ BPA-free

ITEM	DESCRIPTION	UOM	CASE
PL-3N	25-5/8"L x 18"W x 3-1/4"H	Each	6
PL-6N	25-1/2"L x 17-1/2"W x 6"H	Each	3
PL-36NC	Cover	Each	12

Replaces PL-3, PL-6, PL-36C



Stackable



Reinforced edges & corners

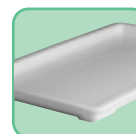

Lid can be used as tray



Seamless fit for fresh storage

## DOUGH SCRAPERS



NEW COLOR

NSF

DSC-2W

DSC-1

NSF

DSC-2

DSC-3

## DOUGH SCRAPERS

- ◆ Stainless steel

ITEM	DESCRIPTION	BLADE	UOM	CASE
DSC-1	Steel Handle	5-1/4" x 4-1/4"	Each	12/48
DSC-2	Plastic Handle, NSF	6" x 3"	Each	12/120
DSC-2W	Plastic Handle, NSF	6" x 3"	Each	12/72
DSC-3	Wooden Handle	6" x 3"	Each	12/72



## ALLERGEN-FREE DOUGH SCRAPERS

Solve the challenges of maintaining an allergen-aware kitchen! Improve customer dining experiences while raising the bar for food safety. Prevent cross-contaminating allergens with this extensive line of Allergen-Free tools by Winco®. Whether it's gluten, nuts or more, use this stand-out purple color to designate these dough scrapers as allergen-free.

ITEM	DESCRIPTION	SIZE	UOM	CASE
DSC-2P	Dough Scraper, S/S Blade	6" x 3"	Each	12/72
PDS-7P	Plastic Dough Scrapers, 6-Pcs/Pk	7-1/2" x 4-3/4"	Pack	24/48



SEE PAGE 251 FOR MORE OF THE ALLERGEN-FREE LINE

Allergen Free

NSF

PDS-7P

DSC-2P

## PLASTIC DOUGH SCRAPERS

- ◆ NSF listed



ITEM	DESCRIPTION	SIZE	UOM	CASE
PDS-7	Large, 6-Pcs/Pk	7-1/2" x 4-3/4"	Pack	24/48
PDS-5	Small, 12-Pcs/Pk	5-1/2" x 3-3/4"	Doz	21/42



NSF

PDS-7

NSF

PDS-5

### DOUGH DIVIDERS WITH ADJUSTABLE WHEELS

- ◆ Stainless steel wheels adjustable from 3/4" to approximately 4-3/4" for ADD-6 and 4-3/8" for ADD-5

ITEM	DESCRIPTION	UOM	CASE
ADD-5	5-Wheel	Each	36
ADD-6	6-Wheel	Each	36

### DOUGH ROLLER DOCKERS

- ◆ Stainless steel handle
- ◆ 8" Overall Length

ITEM	DESCRIPTION	UOM	CASE
RD-2	2-5/8"W Head	Each	1/24
RD-5	5"W Head	Each	1/24
RD-8	5"W Head, 8-Wheel	Each	1/24

### PLASTIC ROLLER DOCKERS

- ◆ 6 independently spinning wheels on the RD-4P
- ◆ Prevent bubbles from forming

ITEM	DESCRIPTION	UOM	CASE
RD-4P	4"W Head, Molded Ergonomic Handle	Each	1/24
RD-5P	5"W Head, Plastic Handle	Each	12/72

### DOUGH WHEELS/DOCKERS

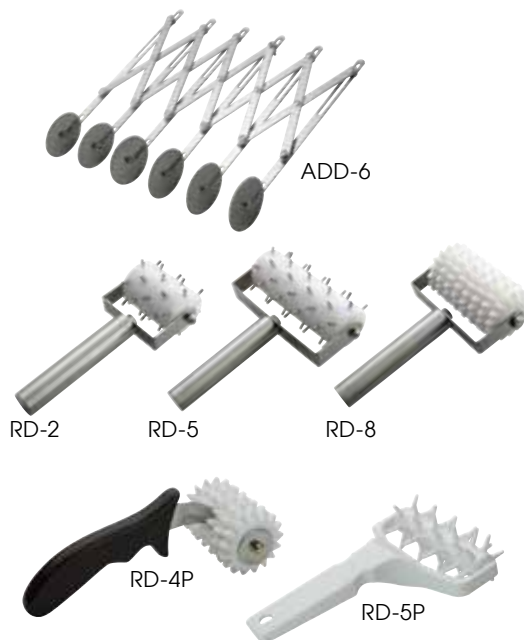

### ALUMINUM ROLLING PINS

ITEM	DESCRIPTION	UOM	CASE
ARP-13	13"L x 3-1/2"Dia	Each	1/6
ARP-15	15"L x 3-1/2"Dia	Each	1/6
ARP-18	18"L x 3-1/2"Dia	Each	1/6

### WOODEN ROLLING PINS

ITEM	DESCRIPTION	UOM	CASE
WRP-13	13"L x 2-3/4" Dia	Each	12
WRP-15	15"L x 2-3/4" Dia	Each	12
WRP-18	18"L x 2-3/4" Dia	Each	12

### FRENCH WOODEN ROLLING PIN

ITEM	DESCRIPTION	UOM	CASE
WRP-20F	20"L x 1-3/16"Dia, Tapered	Each	12/48

### ROLLING PINS



### DOUBLE PASTRY WHEEL

- ◆ Features 2 separate stainless steel blades, straight & fluted
- ◆ Ideal for ravioli, strudel, pastry dough
- ◆ Sturdy stainless steel blades with ergonomic plastic handle
- ◆ Safety guard for hand protection
- ◆ Hole in handle for convenient hanging
- ◆ Dishwasher safe

ITEM	DESCRIPTION	UOM	CASE
PPC-1D	Double Pastry Wheel	Each	12/144

### ECONOMY PASTRY BLENDER

ITEM	DESCRIPTION	UOM	CASE
PST-5B	5 Blades, S/S	Each	12/72

### PERFECT PIE BLENDER

*The Connoisseur pastry blender is faster, cleaner, easier, and more consistent than any other pastry utensil on the market today. The ergonomically designed Pastry Pro allows you to make perfect pastry in 60 seconds!*

- ◆ Patented stainless steel diamond shape cutting blades designed to cut through flour and butter
- ◆ Rubberized handle
- ◆ Dishwasher safe

ITEM	DESCRIPTION	UOM	CASE
PSTCO-7	7 Blades	Each	6/24

### PASTRY TOOLS





## BATTER DISPENSERS



## ALUMINUM PANCAKE DISPENSER

- ◆ Durable plunger ensures consistent amounts of batter every time
- ◆ Eight portion-control settings range from 1/2 oz to 8 oz
- ◆ 10 gauge high-grade aluminum body
- ◆ Long lasting parts prevent clogging and leaking

ITEM	DESCRIPTION	UOM	CASE
APCD-6	Pancake Dispenser	Each	1/6
APCD-6R	Rack for APCD-6, No Retail Pkg.	Each	12/48

## CONFECTIONERY FUNNEL

- ◆ Use to dispense a smooth flow of fondant, syrup, or prepared creams
- ◆ Spring valve feature allows for easy control with single-handed operation
- ◆ Comes with 3 nozzles: 4mm, 5mm, 6mm
- ◆ Rack not included

ITEM	DESCRIPTION	UOM	CASE
SF-7	Funnel, S/S	Each	1/8
SF-7R	Rack for SF-7, S/S	Each	1/24

## SIFTERS



## ROTARY SIFTER

ITEM	DESCRIPTION	UOM	CASE
RFS-8	8 Cup, S/S	Each	1/12

## SIEVES

- ◆ Stainless steel #20 mesh

ITEM	DESCRIPTION (DIA X H)	UOM	CASE
SIV-10	10" x 3"	Each	1/6
SIV-12	12" x 3"	Each	1/6
SIV-14	14" x 3"	Each	1/6
SIV-16	16" x 3"	Each	1/6

## FUNNELS



## WIDE-MOUTH FUNNELS & REMOVABLE STRAINERS

- ◆ Stainless steel mirror finish for SF-5 and SF-6

ITEM	DESCRIPTION	UOM	CASE
SF-5	5" Funnel	Each	12/72
SF-6	5-3/4" Funnel	Each	12/72
SF-6S	Strainer for SF-6	Each	120/480

## SPUN ALUMINUM FUNNELS

- ◆ Made of one-piece spun aluminum

ITEM	DESCRIPTION	UOM	CASE
SAF-05	1/2 Pt, 3-7/8"Dia x 3-5/8"H	Each	12/192
SAF-1ST	1 Pt w/Strainer, 5-1/4"Dia x 5-1/4"H	Each	6/150
SAF-2	1 Qt, 7"Dia x 6-5/8"H	Each	6/54
SAF-4	2 Qt, 9-1/8"Dia x 7-3/4"H	Each	6/72

## PLASTIC FUNNELS

ITEM	DESCRIPTION	UOM	CASE
PF-8	8 Oz, 4"Dia	Each	6/324
PF-16	16 Oz, 5-1/4"Dia	Each	6/324
PF-32	32 Oz 6-1/4"Dia	Each	6/216

SAF-1ST inside detail

### STRAINER-SIFTER

Give baked delicacies a flavorful finish with this 3 inch sifter. The fine mesh makes it possible to craft that light sprinkle of powdered sugar, cocoa, nutmeg, etc.

- ◆ Stainless steel

ITEM	DESCRIPTION	UOM	CASE
MS2K-3S	8"L x 1"H O.L., 3"Dia	Each	24/144

### STRAINER-SIFTER



MS2K-3S

### POWDERED SUGAR DISPENSER

- ◆ Stainless steel
- ◆ Also ideal for cocoa, nutmeg or cinnamon
- ◆ Includes plastic cap

ITEM	DESCRIPTION	UOM	CASE
SSD-10	10 Oz	Each	12/60

### DREDGES



SSD-10



Includes plastic cap

### ADJUSTABLE SHAKER DREDGE

- ◆ 18/8 stainless steel mirror finish
- ◆ Features a three-way adjustable top with small, medium and large holes

ITEM	DESCRIPTION	UOM	CASE
DRG-8P	8 Oz	Each	12/96



DRG-8P



DRG-8P Adjustable Tap

### STAINLESS STEEL DREDGES

ITEM	DESCRIPTION	UOM	CASE
DRG-10	10 Oz w/Handle	Each	12/144
DRG-10H	10 Oz w/o Handle	Each	12/144
DRG-22H	22 Oz w/o Handle	Each	12/48



DRG-10



DRG-10H



DRG-22H

### ALUMINUM DREDGES

ITEM	DESCRIPTION	UOM	CASE
ADRG-10	10 Oz w/ Handle	Each	12/144
ADRG-10H	10 Oz w/o Handle	Each	12/144



ADRG-10



ADRG-10H

### PLASTIC DREDGE SETS

- ◆ 10 oz polycarbonate dredge sets with snap-on lids
- ◆ NSF listed

ITEM	DESCRIPTION	UOM	CASE
PDG-10	Dredge w/3 Clear Lids (S, M, L)	Set	1/48
PDG-10AC	Dredge w/4 Colored Lids	Set	1/48
PDG-10CS	10 Oz Dredge w/Clear S Lid	Set	12/48
PDG-10CM	10 Oz Dredge w/Clear M Lid	Set	12/48
PDG-10CL	10 Oz Dredge w/Clear L Lid	Set	12/48
PDG-10CXL	10 Oz Dredge w/Clear XL Lid	Set	12/48
PDG-10B	10 Oz Dredge w/Beige Lid	Set	12/48
PDG-10G	10 Oz Dredge w/Green Lid	Set	12/48
PDG-10R	10 Oz Dredge w/Rose Lid	Set	12/48
PDG-10Y	10 Oz Dredge w/Yellow Lid	Set	12/48



PDG-10AC

PDG-10

PDG-SERIES NSF

### PLASTIC COLORED DREDGE LIDS

- ◆ Fits both PDG-10 and PDG-10AC dredges
- ◆ Each pack contains six (6) pieces

ITEM	DESCRIPTION	UOM	CASE
PDG-BL	Beige Lids	Pack	72/144
PDG-GL	Green Lids	Pack	72/144
PDG-RL	Rose Lids	Pack	72/144
PDG-YL	Yellow Lids	Pack	72/144



PDG-SERIES COLORED LIDS

## PASTRY BRUSHES

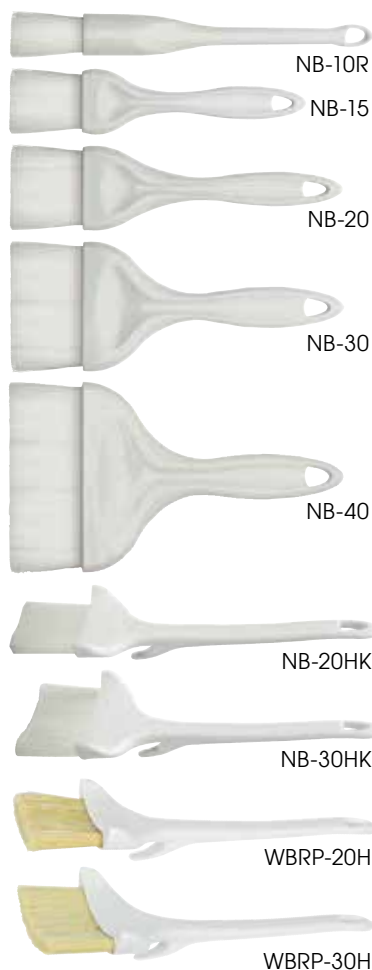

**BPA FREE**



## NYLON BRISTLE PASTRY BRUSHES

Made for long lasting use, nylon bristle pastry brushes are versatile enough to use for basting meats or glazing pastries. Available in a variety of sizes to suit every need.

- ◆ Bristles are epoxy-set to ferrules which prevent bacteria from collecting
- ◆ Bristles are heat resistant up to 300°F (150°C)
- ◆ One-piece smooth-finish plastic handle for easy cleaning
- ◆ Dishwasher safe

ITEM	DESCRIPTION	SIZE	UOM	CASE
NB-10R	Round Brush	1" Dia	Each	12/240
NB-15	Flat Brush	1-1/2"	Each	12/240
NB-20	Flat Brush	2"	Each	12/240
NB-20HK	Concave With Hook	2"	Each	12/120
NB-30	Flat Brush	3"	Each	12/120
NB-30HK	Concave With Hook	3"	Each	12/120
NB-40	Flat Brush	4"	Each	12/120

## BOAR BRISTLE PASTRY BRUSHES

Made for heavy or thick sauces, boar bristle pastry brushes are ideal for basting meat and poultry.

- ◆ Concave natural boar bristles with plastic hook handle
- ◆ Bristles are heat resistant up to 500°F (260°C)
- ◆ Hook allows the brush to rest on the edge of a pot or pan

ITEM	DESCRIPTION	SIZE	UOM	CASE
WBRP-20H	Concave With Hook	2"	Each	12/72
WBRP-30H	Concave With Hook	3"	Each	12/72

## PASTRY/BASTING BRUSHES

- ◆ Natural boar hair bristles
- ◆ WFB: wooden handle with plastic ferrules
- ◆ WBR: wooden handle with metal ferrules

ITEM	DESCRIPTION	SIZE	UOM	CASE
WFB-10	Flat Brush	1"	Each	12/144
WFB-10R	Round Brush	1" x 2"	Each	12/144
WFB-15	Flat Brush	1-1/2"	Each	12/144
WFB-20	Flat Brush	2"	Each	12/144
WFB-30	Flat Brush	3"	Each	12/72
WFB-40	Flat Brush	4"	Each	12/72
WBR-10	Flat Pastry Brush	1"	Each	12/600
WBR-15	Flat Pastry Brush	1-1/2"	Each	12/600
WBR-20	Flat Pastry Brush	2"	Each	12/240
WBR-25	Flat Pastry Brush	2-1/2"	Each	12/240
WBR-30	Flat Pastry Brush	3"	Each	12/240
WBR-40	Flat Pastry Brush	4"	Each	12/240

## PLASTIC BASTER

- ◆ 1.5 oz capacity with rubber bulb
- ◆ BPA-free

ITEM	DESCRIPTION	UOM	CASE
PBST-1.5	7-1/2" Tube, 11" O.L.	Each	12/72

## OIL MOP

ITEM	DESCRIPTION	UOM	CASE
OM-13	13" O.L.	Each	12/96

### SILICONE BRUSH

The perfect tool for brushing on marinades, oil or butter onto meats, fish or breads! This silicone brush won't scratch foods and is non-stick friendly.

- ◆ Non-stick friendly and easy to clean
- ◆ 100% silicone exterior; stainless steel interior
- ◆ Heat resistant up to 428°F (220°C)
- ◆ Dishwasher safe for easier cleanup
- ◆ BPA-free

ITEM	DESCRIPTION	UOM	CASE
SB-175R	1-3/4" W	Each	24/144

### SILICONE BRUSH



SB-175R

BPA FREE

### TIMERS

ITEM	DESCRIPTION	TIME	UOM	CASE
TIM-78	Mechanical Timer	60 min	Each	12/36
TIM-85D	LCD Digital Timer w/20 min Stopper	20 hrs	Each	12/144

### TIMERS & OVEN MITTS



TIM-85D



TIM-78

### FLAME RETARDANT OVEN MITTS

- ◆ Flame-resistant up to 400°F (205°C)
- ◆ OMF-24 is extra-long for full arm protection

ITEM	DESCRIPTION	UOM	CASE
OMF-13	13"	Each	12/72
OMF-15	15"	Each	12/72
OMF-17	17"	Each	12/72
OMF-24	24"	Each	12/72



OMF-SERIES

### OVEN MITTS

- ◆ Heat-resistant up to 200°F (93°C)
- ◆ 100% cotton

ITEM	DESCRIPTION	UOM	CASE
OMS-13	13"	Each	12/72
OMS-15	15"	Each	12/72
OMS-17	17"	Each	12/72



OMS-SERIES

### TERRY OVEN MITTS

- ◆ Heat-resistant up to 600°F (315°C)

ITEM	DESCRIPTION	UOM	CASE
OMT-13	13"	Each	12/72
OMT-17	17"	Each	12/72



OMT-SERIES

### POT HOLDERS

ITEM	DESCRIPTION	SIZE	UOM	CASE
PH-8B	One Side Fire Retardant, Other Side Terrycloth	8" x 8"	Doz	1/25
PH-8S	Cotton	8" x 8"	Doz	1/25
PH-9W	White Terrycloth w/Pocket	8-1/2" x 9-1/2"	Doz	1/15

### POT HOLDERS



PH-8B



PH-8S



PH-9W



SCRAPERS

SEE PAGE 251 FOR MORE OF THE ALLERGEN-FREE LINE



PSH-16P



IMPROVED DESIGN

PSH-series features raised ridges on the blade

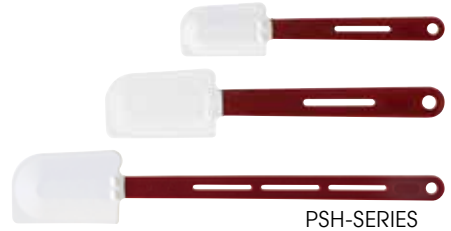

PSH-SERIES



PSG-SERIES



PSD-SERIES



PSGE-SERIES

BPA FREE



PSC-SERIES

BPA FREE

New Item

ALLERGEN-FREE COLOR CODED SCRAPER

Solve the challenges of maintaining an allergen-aware kitchen! Improve customer dining experiences while raising the bar for food safety. Prevent cross-contaminating allergens with the extensive line of Allergen-Free tools by Winco®. Whether it's gluten, nuts or more, use this stand-out purple color to designate these scrapers as allergen-free.

- ◆ Features raised ridges for resting to prevent messy counters
- ◆ Nylon handles heat-resistant up to 600°F (315°C)

ITEM	DESCRIPTION	UOM	CASE
PSH-10P	10-1/2"	Each	24/144
PSH-14P	14"	Each	24/144
PSH-16P	16-1/4"	Each	24/144

SILICONE SCRAPERS

- ◆ Features raised ridges for resting to prevent messy counters
- ◆ Nylon handles heat-resistant up to 600°F (315°C)

ITEM	DESCRIPTION	UOM	CASE
PSH-10	10-1/2"	Each	24/144
PSH-14	14"	Each	24/144
PSH-16	16-1/4"	Each	24/144

BOWL-SHAPED SILICONE SCRAPERS

- ◆ Heat-resistant up to 500°F (260°C)

ITEM	DESCRIPTION	UOM	CASE
PSG-10	10"	Each	12/120
PSG-14	14"	Each	12/120
PSG-16	16"	Each	12/120

ECONOMY SILICONE SCRAPERS

- ◆ Heat-resistant up to 500°F (260°C)

ITEM	DESCRIPTION	UOM	CASE
PSD-10	10"	Each	12/120
PSD-14	14"	Each	12/120
PSD-16	16"	Each	12/120

BOWL-SHAPED PLASTIC SCRAPERS

- ◆ BPA-free

ITEM	DESCRIPTION	UOM	CASE
PSGE-10	10"	Each	12/120
PSGE-14	14"	Each	12/72
PSGE-16	16"	Each	12/36

PLASTIC SCRAPERS

- ◆ BPA-free

ITEM	DESCRIPTION	UOM	CASE
PSC-10	10"	Each	24/360
PSC-14	14"	Each	12/288
PSC-16	16"	Each	12/288

### STAINLESS STEEL MIXING PADDLES

ITEM	DESCRIPTION	UOM	CASE
MPD-24	24"	Each	12
MPD-36	36"	Each	12
MPD-48	48"	Each	12
MPD-60	60"	Each	12

### WOODEN STIRRING PADDLES

ITEM	DESCRIPTION	UOM	CASE
WSP-18	18"	Each	4/36
WSP-24	24"	Each	4/36
WSP-36	36"	Each	4/36
WSP-48	48"	Each	4/36

### NYLON MIXING PADDLES

Mix, fold or spread anything from icing to batters with this nylon mixing paddle. The stain-resistant, sturdy one-piece construction is resistant to high temperatures, making it ideal for melting chocolate on hot stove tops.

- ◆ High temperature nylon is heat-resistant up to 400°F (204°C)

ITEM	DESCRIPTION	UOM	CASE
NSP-10W	10"	Each	12/120
NSP-14W	14"	Each	12/120
NSP-20W	20"	Each	12/120

### HIGH HEAT NYLON SPOONS

- ◆ One-piece construction, ideal for non-stick cookware
- ◆ Stain resistant; Heat resistant up to 400°F (204°C)

ITEM	DESCRIPTION	UOM	CASE
NS-12B	12", Blue	Each	24/144
NS-12R	12", Red	Each	24/144
NS-12T	12", Tan	Each	24/144
NS-12W	12", Off-white	Each	24/144
NS-15B	15", Blue	Each	24/72
NS-15R	15", Red	Each	24/72
NS-15T	15", Tan	Each	24/72
NS-15W	15", Off-white	Each	24/72

### WOODEN SPOONS

ITEM	DESCRIPTION	UOM	CASE
WWP-12	12"	Doz	1/8
WWP-14	14"	Doz	1/8
WWP-16	16"	Doz	1/8
WWP-18	18"	Doz	1/8

### DELUXE MEASURING CUPS

- ◆ Molded one-piece break-resistant polycarbonate; Heat resistant up to 210°F (98°C)
- ◆ Raised external markings in both quarts (red letters) and liters (blue letters)
- ◆ Tapered open handle for a secure grip; stackable
- ◆ Dishwasher safe

ITEM	DESCRIPTION	UOM	CASE
PMCP-25	1 Cup	Each	6/72
PMCP-50	1 Pint	Each	6/72
PMCP-100	1 Qt	Each	6/36
PMCP-200	2 Qt	Each	6/36
PMCP-400	4 Qt	Each	6/24
PMCP-5SET	Complete 5-pc Set	Set	1/6

### MEASURING CUPS

- ◆ Durable polycarbonate w/raised graduation markings
- ◆ NSF listed

ITEM	DESCRIPTION	UOM	CASE
PMU-25	1 Cup	Each	36
PMU-50	1 Pint	Each	36
PMU-100	1 Qt	Each	36
PMU-200	2 Qt	Each	36
PMU-400	4 Qt	Each	12

### PADDLES & SPOONS



MPD-24

MPD-36

WSP-24

NSP-10W

NSP-SERIES



NS-15B

NS-15R

NS-15T

NS-15W

NS-SERIES



WWP-SERIES

### MEASURING CUPS



PMCP-SERIES



PMU-SERIES



## MEASURING TOOLS

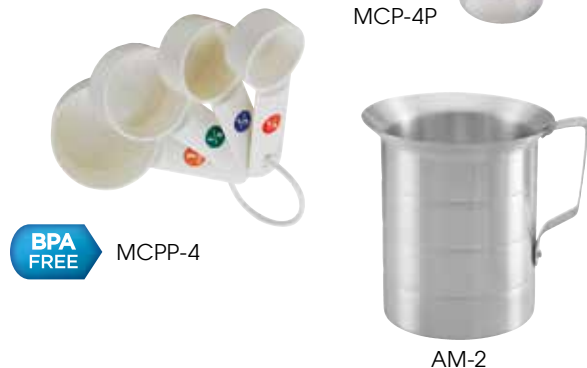
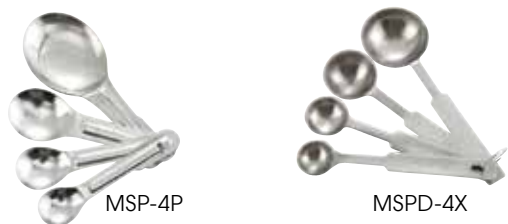
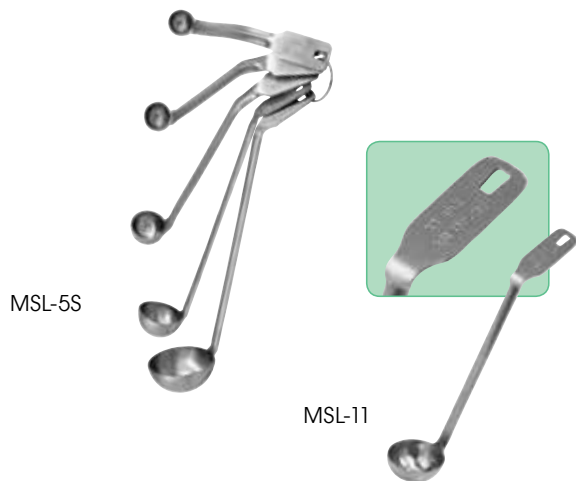

## MINI MEASURING LADLES

Easily portion and serve smaller quantities with mini ladles in varying capacities.

- ◆ Ideal for either measuring or serving small quantities
- ◆ Durable 18/8 stainless steel construction
- ◆ Capacity stamped on each handle

ITEM	DESCRIPTION	UOM	CASE
MSL-5S	5-Pc Set: 1/8 Tsp, 1/4 Tsp, 1/2 Tsp, 1 Tsp, 1 Tbsp	Set	12/72
MSL-11	3/4 Tbsp	Each	60/300



## STAINLESS STEEL MEASURING SPOON SETS

- ◆ Sets includes: 1/4 Tsp, 1/2 Tsp, 1 Tsp, 1 Tbsp

ITEM	DESCRIPTION	UOM	CASE
MSP-4P	4-Pc Set	Set	12/288
MSPD-4X	Deluxe 4-Pc Set	Set	24/240

## PLASTIC MEASURING SPOON SET

- ◆ Set includes: 1/4 Tsp, 1/2 Tsp, 1 Tsp, 1 Tbsp
- ◆ BPA-free

ITEM	DESCRIPTION	UOM	CASE
MSPP-4	4-Pc Set	Set	12/216

## STAINLESS STEEL MEASURING CUP SET

- ◆ Set includes: 1/4 Cup, 1/3 Cup, 1/2 Cup, 1 Cup

ITEM	DESCRIPTION	UOM	CASE
MCP-4P	4-Pc Set	Set	12/48

## PLASTIC MEASURING CUP SET

- ◆ Set includes: 1/4 Cup, 1/3 Cup, 1/2 Cup, 1 Cup
- ◆ BPA-free

ITEM	DESCRIPTION	UOM	CASE
MCPP-4	4-Pc Set	Set	12/72

## ALUMINUM MEASURES

ITEM	DESCRIPTION	UOM	CASE
AM-05	1/2 Qt	Each	1/48
AM-1	1 Qt	Each	1/36
AM-2	2 Qt	Each	1/36
AM-4	4 Qt	Each	1/24

## STAINLESS STEEL MEASURING BOWLS

- ◆ With interior graduations

ITEM	DESCRIPTION	UOM	CASE
SMB-4	4 Cups	Each	48
SMB-6	6 Cups	Each	24
SMB-10	10 Cups	Each	24



## PIZZA PANS

PIZZA PANS ARE IN STOCK, CUSTOM ORDER NOT REQUIRED

### WIDE-RIM PIZZA PANS

- ◆ All-purpose wide-rim pan allows for baking and serving straight out of the oven
- ◆ Aluminum

ITEM	DESCRIPTION	UOM	CASE
APZT-7	7"	Each	36/72
APZT-8	8"	Each	36/144
APZT-9	9"	Each	36/72
APZT-10	10"	Each	36/72
APZT-11	11"	Each	36/72
APZT-12	12"	Each	36/72
APZT-13	13"	Each	36/72
APZT-14	14"	Each	24/48
APZT-15	15"	Each	24/48
APZT-16	16"	Each	24/48
APZT-17	17"	Each	12/36
APZT-18	18"	Each	12/36
APZT-19	19"	Each	12/24
APZT-20	20"	Each	12/24



APZT-SERIES

### COUPE-STYLE PIZZA PANS

- ◆ Ideal for baking and serving thin crust pizzas
- ◆ Aluminum

ITEM	DESCRIPTION	UOM	CASE
APZC-8	8"	Each	36/144
APZC-9	9"	Each	36/144
APZC-10	10"	Each	36/72
APZC-11	11"	Each	36/72
APZC-12	12"	Each	36/72
APZC-13	13"	Each	36/72
APZC-14	14"	Each	24/48
APZC-15	15"	Each	24/48
APZC-16	16"	Each	24/48
APZC-18	18"	Each	12/36



APZC-SERIES

### ALUMINUM TRAYS WITH NIBS

An essential to producing savory, crispy pizza crusts every time, trays with nibs raise the dough 1/8" above the surface to allow moisture to escape while baking.

ITEM	DESCRIPTION	UOM	CASE
APZN-6	6"	Each	36/72
APZN-8	8"	Each	36/72
APZN-9	9"	Each	36/72
APZN-10	10"	Each	36/72
APZN-12	12"	Each	24/48
APZN-16	16"	Each	24/48
APZN-20	20"	Each	12/24



APZN-SERIES

### STACKABLE ALUMINUM PIZZA PANS

- ◆ 1-1/2" pan depth
- ◆ 1" clearance between pans when stacked

ITEM	DESCRIPTION	UOM	CASE
APZK-0615	6"	Each	6/24
APZK-0815	8"	Each	6/24
APZK-1015	10"	Each	6/24
APZK-1215	12"	Each	6/12
APZK-1415	14"	Each	6/12
APZK-1615	16"	Each	6/12



Stackable



APZK-1615



## PIZZA PANS



SPP-1218

SPP-1616

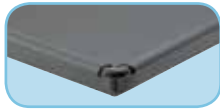

Durable heavyweight cold-rolled steel



HAC-162

SEE PAGE 207 FOR MORE PAN OPTIONS



## SICILIAN PIZZA PANS

A must-have for making traditional thick-and-chewy Sicilian pizzas.

- ◆ Tapered design and fully nesting
- ◆ Non-stick coating provides even-heat transfer
- ◆ Durable heavyweight cold-rolled steel

ITEM	DESCRIPTION	UOM	CASE
SPP-1218	12"L x 18"W x 1"H	Each	12
SPP-1616	16"L x 16"W x 1"H	Each	12



## DEEP DISH PIZZA PANS

- ◆ Great for deep dish pizzas
- ◆ 1.0mm, 18 gauge hard anodized aluminum

ITEM	DESCRIPTION	UOM	CASE
HAC-082	8"Dia x 2"H	Each	6/24
HAC-102	10"Dia x 2"H	Each	6/24
HAC-122	12"Dia x 2"H	Each	6/24
HAC-142	14"Dia x 2"H	Each	6/24
HAC-162	16"Dia x 2"H	Each	6/12

## PERFORATED PIZZA DISKS

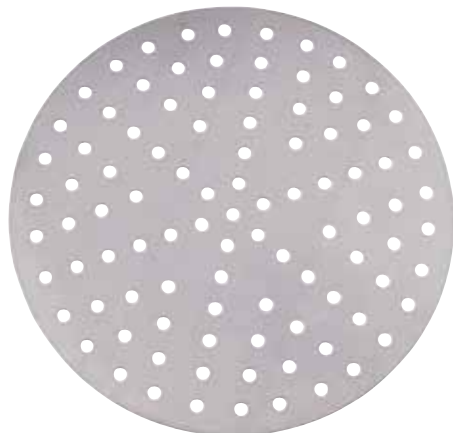

APZP-12P

PIZZA PANS ARE IN STOCK, CUSTOM ORDER NOT REQUIRED

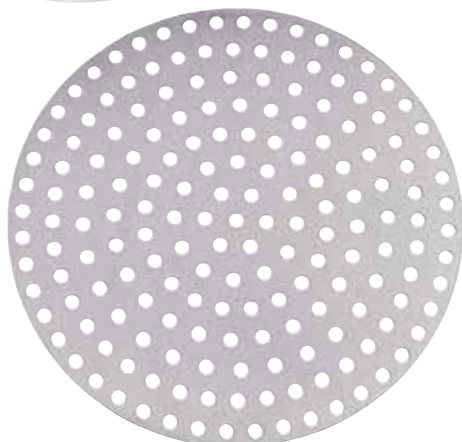

APZP-12SP

## ALUMINUM PERFORATED DISKS

Perforated with 3/8" diameter holes, these pizza disks help to reduce cooking time and allow air circulation to achieve evenly baked crusts.

ITEM	DESCRIPTION	UOM	CASE
APZP-7P	7"Dia, 35 Holes	Each	36/144
APZP-8P	8"Dia, 43 Holes	Each	36/144
APZP-9P	9"Dia, 43 Holes	Each	36/144
APZP-10P	10"Dia, 67 Holes	Each	36/144
APZP-11P	11"Dia, 97 Holes	Each	36/144
APZP-12P	12"Dia, 97 Holes	Each	36/144
APZP-13P	13"Dia, 133 Holes	Each	36/72
APZP-14P	14"Dia, 133 Holes	Each	36/72
APZP-15P	15"Dia, 175 Holes	Each	36/72
APZP-17P	17"Dia, 223 Holes	Each	36
APZP-18P	18"Dia, 223 Holes	Each	36
APZP-19P	19"Dia, 283 Holes	Each	36
APZP-20P	20"Dia, 349 Holes	Each	36

## ALUMINUM SUPER-PERFORATED DISKS

Perforated with more 3/8" diameter holes, these pizza disks reduce cooking time and allow air circulation to achieve evenly baked crusts.

- ◆ Nearly twice the amount of holes for faster cooking

ITEM	DESCRIPTION	UOM	CASE
APZP-7SP	7"Dia, 63 Holes	Each	36/144
APZP-8SP	8"Dia, 63 Holes	Each	36/144
APZP-9SP	9"Dia, 91 Holes	Each	36/144
APZP-10SP	10"Dia, 91 Holes	Each	36/144
APZP-11SP	11"Dia, 131 Holes	Each	36/144
APZP-13SP	13"Dia, 179 Holes	Each	36/72
APZP-14SP	14"Dia, 231 Holes	Each	36/72
APZP-15SP	15"Dia, 291 Holes	Each	36/72
APZP-17SP	17"Dia, 351 Holes	Each	36
APZP-19SP	19"Dia, 415 Holes	Each	36
APZP-20SP	20"Dia, 487 Holes	Each	36

### ALUMINUM PIZZA SCREENS

◆ Mesh bottom helps transfer heat to create a crispier crust

ITEM	DESCRIPTION	UOM	CASE
APZS-7	7"	Each	12/120
APZS-8	8"	Each	12/120
APZS-9	9"	Each	12/120
APZS-10	10"	Each	12/120
APZS-11	11"	Each	12/120
APZS-12	12"	Each	12/120
APZS-13	13"	Each	12/120
APZS-14	14"	Each	12/120
APZS-15	15"	Each	12/120
APZS-16	16"	Each	12/120
APZS-17	17"	Each	12/120
APZS-18	18"	Each	12/60
APZS-19	19"	Each	12/60
APZS-20	20"	Each	12/60

### PIZZA SCREENS



APZS-7

PIZZA PANS ARE IN STOCK, CUSTOM ORDER NOT REQUIRED



AMS-8

### ALUMINUM MEGA SCREENS

*The ideal choice for conveyor oven use, these mega pizza screens are made of heavy-duty aluminum so they last up to ten times longer than standard screens.*

ITEM	DESCRIPTION	UOM	CASE
AMS-7	7" Inner Dia, 7-3/4" Outer Dia	Each	12/144
AMS-8	8" Inner Dia, 8-1/4" Outer Dia	Each	12/144
AMS-9	9" Inner Dia, 9-3/4" Outer Dia	Each	12/144
AMS-11	11" Inner Dia, 11-3/4" Outer Dia	Each	12/72
AMS-15	15" Inner Dia, 15-3/4" Outer Dia	Each	12/48
AMS-17	17" Inner Dia, 17-3/4" Outer Dia	Each	12/36

### PIZZA PAN STAND

- ◆ Simple, attractive stand raises 6-1/2" above surface
- ◆ Ideal for tabletop with limited space

ITEM	DESCRIPTION	UOM	CASE
APZT-789	Chrome Plated Steel	Each	20

### STAND & RACK

NON-SLIP GRIP



APZT-789

IMPROVED STRUCTURE



APZT-1015

### PIZZA PAN RACK

- ◆ 1-5/8" spacing between each level
- ◆ Overall height is 27"
- ◆ Base measures 12" x 12"

ITEM	DESCRIPTION	UOM	CASE
APZT-1015	15 Tiers, Welded	Each	2

### PIZZA PAN GRIPPERS

ITEM	DESCRIPTION	UOM	CASE
PPG-8	Gripper for Deep Pizza Pans	Each	12/60
PPG-8A	Heavy-duty Cast Aluminum Gripper	Each	12/48
PPG-8S	Gripper for Shallow Pizza Pans	Each	6/60

### PIZZA PAN GRIPPERS

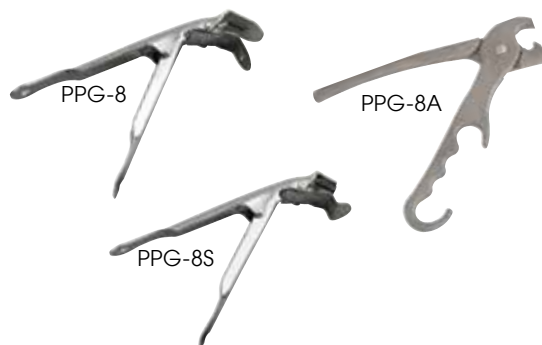

PPG-8

PPG-8A

PPG-8S

## BUBBLE POPPERS



## PIZZA BUBBLE POPPERS

Say goodbye to unsightly pizza bubbles with pizza poppers, the long-reach tools that deflate dough bubbles while pizza is cooking in the oven.

ITEM	DESCRIPTION	O.L.	UOM	CASE
PZP-32	Aluminum	32"	Each	24/48
PZP-38WH	Wooden Handle	38"	Each	12/24

## PEELS



## ALUMINUM PIZZA/BURGER PEEL

- ◆ 14 gauge, 1.6mm thick
- ◆ 11"L handle

ITEM	DESCRIPTION	O.L.	UOM	CASE
APP-20	6-3/4" x 9" Blade	20"	Each	12/48

## ALUMINUM PIZZA PEELS

- ◆ Wooden handle

ITEM	DESCRIPTION	O.L.	UOM	CASE
APP-26	12" x 14" Blade	26"	Each	6/12
APP-36	12" x 14" Blade	36"	Each	6/12
APP-52	12" x 14" Blade	52"	Each	6/12
APP-10M	14" x 16" Blade	26"	Each	6/12
APP-18M	14" x 16" Blade	34"	Each	6/12
APP-18L	16" x 18" Blade	36"	Each	6/12

## WOODEN PIZZA PEELS

ITEM	DESCRIPTION	O.L.	UOM	CASE
WPP-1222	12" x 13" Blade	22"	Each	12
WPP-1236	12" x 13" Blade	36"	Each	12
WPP-1242	12" x 13" Blade	42"	Each	12
WPP-1424	14" x 15" Blade	24"	Each	12
WPP-1436	14" x 15" Blade	36"	Each	12
WPP-1442	14" x 15" Blade	42"	Each	12
WPP-1642	16" x 17-1/2" Blade	42"	Each	6
WPP-1842	18" x 19" Blade	42"	Each	6
WPP-2042	20" x 20" Blade	42"	Each	6

## PIZZA KNIVES & CUTTERS



## PIZZA CUTTERS

- ◆ NSF listed (Plastic handles)

ITEM	DESCRIPTION	BLADE	UOM	CASE
PWC-4	Wooden Handle	4" Dia	Each	12/72
PPC-2	Black PP Hdl, NSF	2-1/2" Dia	Each	12/72
PPC-4	Black PP Hdl, NSF	4" Dia	Each	12/72
PPC-2W	White Handle, NSF	2-1/2" Dia	Each	12/72
PPC-4W	White Handle, NSF	4" Dia	Each	12/72
VP-315	Small, Soft Grip Handle, NSF	2-1/2" Dia	Each	12/72
VP-316	Large, Soft Grip Handle, NSF	4" Dia	Each	12/72

**NSF** PPC & VP-SERIES

## PIZZA KNIVES

- ◆ NSF listed

ITEM	DESCRIPTION	UOM	CASE
KPP-18	18" Pizza Knife	Each	6/24
KPP-20	20" Pizza Rocker Knife	Each	6/24



**NSF** PIZZA KNIVES

**PIZZA SERVER**

- ◆ Stainless steel
- ◆ Reinforced ergonomic PP handle
- ◆ NSF listed

ITEM	DESCRIPTION	UOM	CASE
TKP-62	6-7/8" x 5-7/8"	Each	6/24

**PIZZA SERVING TONGS**

*No more burnt hands/fingers with this sanitary solution for serving hot slices!*

- ◆ 18/8 stainless steel
- ◆ Dishwasher Safe

ITEM	DESCRIPTION	UOM	CASE
PZG-6	5-1/2" x 4-1/2" Blade	Each	12/48

**PIZZA SERVERS**



**ADJUSTABLE SHAKER DREDGE**

- ◆ 18/8 stainless steel mirror finish
- ◆ Features a three-way adjustable top with small, medium and large holes

ITEM	DESCRIPTION	UOM	CASE
DRG-8P	8 Oz	Each	12/96

**DREDGES**



**STAINLESS STEEL DREDGES**

ITEM	DESCRIPTION	UOM	CASE
DRG-10	10 Oz w/ Handle	Each	12/144
DRG-10H	10 Oz w/o Handle	Each	12/144
DRG-22H	22 Oz w/o Handle	Each	12/48

**ALUMINUM DREDGES**

ITEM	DESCRIPTION	UOM	CASE
ADRG-10	10 Oz w/ Handle	Each	12/144
ADRG-10H	10 Oz w/o Handle	Each	12/144

**PLASTIC DREDGE SETS**

- ◆ 10 oz polycarbonate dredge sets with snap-on lids
- ◆ NSF listed

ITEM	DESCRIPTION	UOM	CASE
PDG-10	Dredge w/3 Clear Lids (S,M,L)	Set	1/48
PDG-10AC	Dredge w/4 Colored Lids	Set	1/48
PDG-10CS	10 Oz Dredge w/Clear S Lid	Set	12/48
PDG-10CM	10 Oz Dredge w/Clear M Lid	Set	12/48
PDG-10CL	10 Oz Dredge w/Clear L Lid	Set	12/48
PDG-10CXL	10 Oz Dredge w/Clear XL Lid	Set	12/48
PDG-10B	10 Oz Dredge w/Beige Lid	Set	12/48
PDG-10G	10 Oz Dredge w/Green Lid	Set	12/48
PDG-10R	10 Oz Dredge w/Rose Lid	Set	12/48
PDG-10Y	10 Oz Dredge w/Yellow Lid	Set	12/48



PDG-SERIES W/COLORED LIDS



PDG-SERIES W/CLEAR LIDS

**PLASTIC COLORED DREDGE LIDS**

- ◆ Fits both PDG-10 and PDG-10AC dredges
- ◆ NSF listed

ITEM	DESCRIPTION	UOM	CASE
PDG-BL	Beige Lids, 6-Pcs/Pk	Pack	72/144
PDG-GL	Green Lids, 6-Pcs/Pk	Pack	72/144
PDG-RL	Rose Lids, 6-Pcs/Pk	Pack	72/144
PDG-YL	Yellow Lids, 6-Pcs/Pk	Pack	72/144



PDG-SERIES COLORED LIDS



## DOUGH PREPARATION



ALDP-SERIES



PL-36NC

IMPROVED  
STRUCTURE



PL-3N

PL-6N

PL-SERIES

NSF

BPA  
FREE

## DOUGH RETARDING/PROOFING PANS & COVERS

- ◆ Stackable for easy storage
- ◆ Aluminum

ITEM	DESCRIPTION	UOM	CASE
ALDP-48	48 Oz, 7-7/8"Dia x 3"H	Each	12/24
ALDP-48C	Cover for ALDP-48	Each	120
ALDP-96	96 Oz, 8-3/4"Dia x 3"H	Each	12/24
ALDP-96C	Cover for ALDP-96	Each	120

## DOUGH BOXES & COVER

- ◆ Boxes stack tight to maintain freshness of contents
- ◆ Great for storing and proofing dough
- ◆ Reinforced structure resists breakage or bending over time
- ◆ Made of durable polypropylene
- ◆ BPA-free

ITEM	DESCRIPTION	UOM	CASE
PL-3N	25-5/8"L x 18"W x 3-1/4"H	Each	6
PL-6N	25-1/2"L x 17-1/2"W x 6"H	Each	3
PL-36NC	Cover	Each	12

*Replaces PL-3, PL-6, PL-36C*



Stackable



Reinforced edges & corners

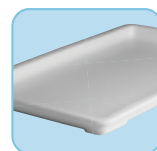

Lid can be used as a tray



Seamless fit for extra fresh storage needs



DWR-2617



Transport dough boxes

## WIRE DOUGH BOX DOLLY

*Transport multiple dough boxes with ease using this wire dolly, currently the only one on the market!*

- ◆ Capacity up to 400 Lbs
- ◆ Winco® exclusive
- ◆ Wheels measure 3-3/4" diameter each

ITEM	DESCRIPTION	UOM	CASE
DWR-2617	27"L x 18-1/4"W x 2-1/2"H	Each	1

## MIXING PADDLES



MPD-24



MPD-36



MPD-48



MPD-60

## STAINLESS STEEL MIXING PADDLES

ITEM	DESCRIPTION	UOM	CASE
MPD-24	24"	Each	12
MPD-36	36"	Each	12
MPD-48	48"	Each	12
MPD-60	60"	Each	12

### STAINLESS STEEL DOUGH SCRAPERS

ITEM	DESCRIPTION	SIZE (L X W)	UOM	CASE
DSC-1	Steel Handle	5-1/4" x 4-1/4"	Each	12/48
DSC-2	Plastic Handle, NSF	6" x 3"	Each	12/120
DSC-2W	Plastic Handle, NSF	6" x 3"	Each	12/72
DSC-3	Wooden Handle	6" x 3"	Each	12/72



### DOUGH SCRAPERS



NEW COLOR

### PLASTIC DOUGH SCRAPERS

ITEM	DESCRIPTION	SIZE (L X W)	UOM	CASE
PDS-7	Large, 6-Pcs/Pk	7-1/2" x 4-3/4"	Pack	24/48
PDS-5	Small, 12-Pcs/Pk	5-1/2" x 3-3/4"	Doz	21/42



### ALLERGEN-FREE DOUGH SCRAPERS

Solve the challenges of maintaining an allergen-aware kitchen! Improve customer dining experiences while raising the bar for food safety. Prevent cross-contaminating allergens with the extensive line of Allergen-Free tools by Winco®. Whether it's gluten, nuts or more, use this stand-out purple color to designate these dough scrapers as allergen-free.

ITEM	DESCRIPTION	SIZE (L X W)	UOM	CASE
DSC-2P	Dough Scraper, Plstc Hdl, S/S Blade	6" x 3"	Each	12/72
PDS-7P	Plastic Dough Scrapers, 6-Pcs/Pk	7-1/2" x 4-3/4"	Pack	24/48



### ALUMINUM ROLLING PINS

◆ 3-1/2" diameter

ITEM	DESCRIPTION	UOM	CASE
ARP-13	13"L	Each	1/6
ARP-15	15"L	Each	1/6
ARP-18	18"L	Each	1/6

### ROLLING PINS



### WOODEN ROLLING PINS

◆ 2-3/4" diameter

ITEM	DESCRIPTION	UOM	CASE
WRP-13	13"L	Each	12
WRP-15	15"L	Each	12
WRP-18	18"L	Each	12



### FRENCH WOODEN ROLLING PIN

◆ 1-3/16" diameter

ITEM	DESCRIPTION	UOM	CASE
WRP-20F	20" Tapered	Each	12/48

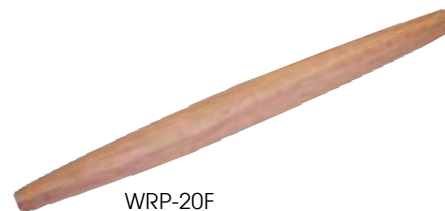

## DOUGH DIVIDERS & DOCKERS

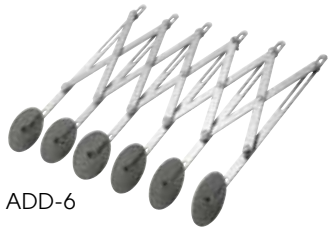

ADD-6

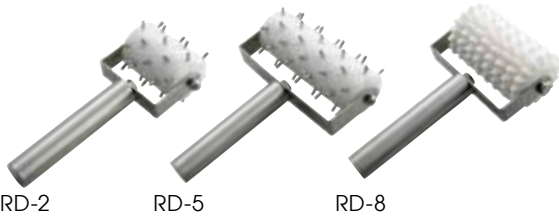

RD-2

RD-5

RD-8



RD-4P

RD-5P

### DOUGH DIVIDERS WITH ADJUSTABLE WHEELS

- ◆ Stainless steel wheels adjustable from 3/4" to approximately 4-3/4" for ADD-6 and 4-3/8" for ADD-5

ITEM	DESCRIPTION	UOM	CASE
ADD-5	5-Wheel	Each	36
ADD-6	6-Wheel	Each	36

### DOUGH ROLLER DOCKERS

- ◆ Stainless steel handle
- ◆ 8" Overall Length

ITEM	DESCRIPTION	UOM	CASE
RD-2	2-5/8"W Head	Each	1/24
RD-5	5"W Head	Each	1/24
RD-8	5"W Head, 8-Wheel	Each	1/24

### PLASTIC ROLLER DOCKERS

- ◆ 6 independently spinning wheels on the RD-4P
- ◆ Prevent bubbles from forming

ITEM	DESCRIPTION	UOM	CASE
RD-4P	4"W Head, Molded Ergonomic Handle	Each	1/24
RD-5P	5"W Head, Plastic Handle	Each	12/72

## ROTARY SIFTER



RFS-8

### ROTARY SIFTER

ITEM	DESCRIPTION	UOM	CASE
RFS-8	8 Cup, S/S	Each	1/12

## SPECIALTY TOOLS

NON-STICK



APHS-7

### ALUMINUM PIZZA HEAT SINK

Say goodbye to burnt crusts and undercooked pizza centers! Place this non-stick pizza heat sink in the center of your deep-dish pizza pies to evenly distribute heat and shorten baking time.

- ◆ Delivers heat to the center of the pizza to evenly bake deep dish and more
- ◆ Effectively shorten baking time
- ◆ 22 pins

ITEM	DESCRIPTION	UOM	CASE
APHS-7	6-3/4"Dia	Each	1/36



Distribute heat through thick centers

### DELIVERY BAGS

- ◆ Outer shell / liner: polyester, Filling: EPE
- ◆ Heat retention: 2 hours @ 167°F; 4 hours @ 131°F; 6 hours @ 95°F

ITEM	DESCRIPTION	UOM	CASE
BGDV-12	12" x 12" x 12"	Each	6
BGDV-22	22" x 22" x 12"	Each	6

### PIZZA BAGS



BGDV-SERIES

### PIZZA BAGS

- ◆ Outer shell / liner: polyester, Filling: EPE
- ◆ Insulated lining keeps food warm for longer periods of time

ITEM	DESCRIPTION	UOM	CASE
BGPZ-18	18" x 18" x 5"	Each	6
BGPZ-20	20" x 20" x 5"	Each	6
BGPZ-24	24" x 24" x 5"	Each	6

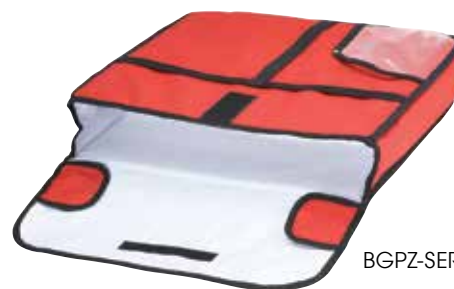

BGPZ-SERIES

### DUAL-HEADED BRUSH

- ◆ Thick brush has steel wire bristles trimmed to 40mm
- ◆ Thin brush has flat steel wire bristles trimmed to 30mm
- ◆ Replacement kit includes dual-head brush, bolt and nut



ITEM	DESCRIPTION	UOM	CASE
BR-21	Dual-Headed Brush with 28" S/S Handle	Each	6

### PIZZA OVEN BRUSHES



BR-21

### PIZZA OVEN/BROILER BRUSH

- ◆ Stiff stainless steel wire bristles make cleaning heavy oven residue effortless
- ◆ Quick and easy removal of heavy carbon deposits, rust and burned-on food buildup

ITEM	DESCRIPTION	UOM	CASE
BR-30	Brush with 30" Hd	Each	8/32

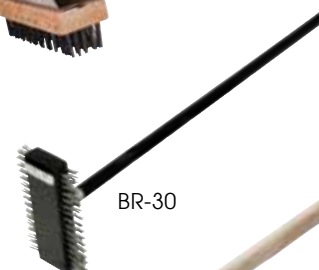

BR-30

### PIZZA OVEN SCRAPER

- ◆ Carbon wire brush and scraper

ITEM	DESCRIPTION	UOM	CASE
BR-27	Scraper with 27" Hd	Each	12



BR-27

### PIZZA OVEN BRUSH HEAD

- ◆ Brass bristles with scraper

ITEM	DESCRIPTION	UOM	CASE
BR-10	Brush Head, 10-1/4" x 1-3/8" x 1-3/4"	Each	12/48
BR-36W	36" Wooden Hd for BR-10	Each	48
BR-60W	55" Wooden Hd For BR-10	Each	6/24



BR-10



BR-36W

BR-60W





## KATTEX FRENCH FRY CUTTERS

**KATTEX**



Can be mounted to wall or counter

HFC-375

**NSF** HFC-SERIES



### QUICK-SLICE FRENCH FRY CUTTERS

- ◆ Short throw handle design for smooth cutting of potatoes into french fries
- ◆ Extremely durable cast iron body with stainless steel components
- ◆ Fixed counter or wall mount; removable with wall bracket (sold separately)
- ◆ Accessories to modify cut sizes and styles sold separately
- ◆ 3-3/8" x 3-3/8" cutting area

ITEM	DESCRIPTION	UOM	CASE
HFC-250	1/4" Cut French Fry Cutter	Set	1
HFC-375	3/8" Cut French Fry Cutter	Set	1
HFC-500	1/2" Cut French Fry Cutter	Set	1

### FRENCH FRY CUTTER ACCESSORIES

ITEM	DESCRIPTION	UOM	CASE
HFC-250R	1/4" Cut Replacement Blade	Set	1/48
HFC-375R	3/8" Cut Replacement Blade	Set	1/48
HFC-500R	1/2" Cut Replacement Blade	Set	1/48
HFC-250B	1/4" Cut Blade Assembly	Set	1/24
HFC-375B	3/8" Cut Blade Assembly	Set	1/24
HFC-500B	1/2" Cut Blade Assembly	Set	1/24
HFC-250K	Pusher Block for 1/4" and 1/2" Cut Blade	Each	1/24
HFC-375K	Pusher Block for 3/8" Cut Blade	Each	1/24
HFC-BK	Wall Bracket for HFC series	Each	1/12

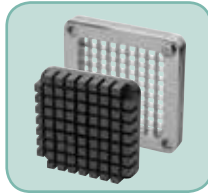

Replacement block and cut blade assembly

## KATTEX TOMATO SLICERS

**KATTEX**



TTS-188

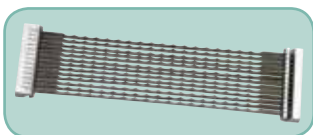

TTS-188S-B

**NSF** TTS-SERIES



### TOMATO SLICERS

*With one quick push, smoothly and swiftly slice tomatoes with the stainless steel Kattex tomato slicer.*

- ◆ Aluminum frame with stainless steel replaceable blade
- ◆ Cuts 2 dozen tomatoes into 3/16" or 1/4" thick slices in 1 minute
- ◆ HDPE board ensures safe & durable food processing
- ◆ NSF listed

ITEM	DESCRIPTION	UOM	CASE
TTS-188	3/16" Blade	Set	1/4
TTS-188S	3/16" Serrated Blade	Set	1/4
TTS-250	1/4" Blade	Set	1/4
TTS-250S	1/4" Serrated Blade	Set	1/4

### TOMATO SLICER ACCESSORIES

ITEM	DESCRIPTION	UOM	CASE
TTS-188-B	3/16" Straight Blade Assembly for TTS-2 and TTS-188	Set	1/12
TTS-188S-B	3/16" Serrated Blade Assembly for TTS-2 and TTS-188	Set	1/12
TTS-250-B	1/4" Straight Blade Assembly for TTS-3 and TTS-250	Set	1/12
TTS-250S-B	1/4" Serrated Blade Assembly for TTS-3 and TTS-250	Set	1/12

### **FRUIT & VEGETABLE SLICER**

Save on time and labor with the Kattex Fruit & Vegetable Slicer by simply putting produce in a holder to turn out uniform slices in seconds.

- ◆ Aluminum construction with 9-1/4" stainless steel adjustable blade
- ◆ 1/16" to 1/2" slice thickness
- ◆ Mounts to countertops and other flat surfaces, can easily be removed for storage and cleaning
- ◆ Can accommodate fruits and vegetables with a maximum of 4" diameter and 5-1/2" in length

ITEM	DESCRIPTION	UOM	CASE
FVS-1	21"L x 10-3/4"W x 16"H	Each	1/2
FVS-1B	Replacement Blades, 2 pc	Set	1/10

## KATTEX FRUIT & VEGETABLE SLICER

# KATTEX



FVS-1

### **FRUIT WEDGE SLICERS**

Get quick and perfect wedges of fruits for salad buffets with just a push of a handle. Ideal for core-less fruits, such as citrus, tomatoes and even potatoes.

- ◆ Aluminum construction with sharp stainless steel blades that minimize squeezing and bruising
- ◆ Sturdy base with non-skid feet
- ◆ 3-1/2" diameter cutting area
- ◆ NSF listed

ITEM	DESCRIPTION	UOM	CASE
FWS-6	6-Wedge	Each	1/4
FWS-8	8-Wedge	Each	1/4

## KATTEX FRUIT WEDGE SLICER

# KATTEX



FWS-8

### **FRUIT WEDGE SLICER ACCESSORIES**

ITEM	DESCRIPTION	UOM	CASE
FWS-6BK	6-Section Wedger & Blade Replacement for FWS-series	Set	1/10
FWS-8BK	8-Section Wedger & Blade Replacement for FWS-series	Set	1/10
FWS-6BC	6-Slice Apple Corer	Each	10
FWS-8BC	8-Slice Apple Corer	Each	10



Replacement wedger and blade



FWS-SERIES



KATTEX CHOPPERS/DICERS  CHOPPERS/DICERS

**KATTEX**

The Kattex Chopper/Dicer produces perfectly diced onions, tomatoes, potatoes and cucumbers too.

- ◆ Cast aluminum construction with stainless steel blades
- ◆ Sturdy base with non-skid feet
- ◆ 3-3/8" x 3-3/8" cutting area
- ◆ NSF listed



HCD-250

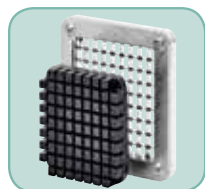

Replacement blade and block

ITEM	DESCRIPTION	UOM	CASE
HCD-250	1/4" Blade Dicer	Each	1/4
HCD-375	3/8" Blade Dicer	Each	1/4
HCD-500	1/2" Blade Dicer	Each	1/4

**CHOPPER/DICER ACCESSORIES**

ITEM	DESCRIPTION	UOM	CASE
HCD-250BK	1/4" Replacement Blade & Block for HCD-series	Set	1/10
HCD-375BK	3/8" Replacement Blade & Block for HCD-series	Set	1/10
HCD-500BK	1/2" Replacement Blade & Block for HCD-series	Set	1/10

 HCD-SERIES

KATTEX LETTUCE CUTTER  LETTUCE CUTTER

**KATTEX**

- ◆ Aluminum frame has easy-grip handle and stainless steel blade with 49-square cuts
- ◆ Cuts lettuce into 1" x 1" slices in less than 1 minute
- ◆ Rubber feet prevent slipping/scratching on work surface
- ◆ 7" x 7" cutting area



TLC-1

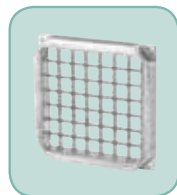

TLC-1-B

ITEM	DESCRIPTION	UOM	CASE
TLC-1	Lettuce Cutter	Each	1/2
TLC-1-B	Replacement Blade for TLC-1	Each	1/10

 TLC-SERIES

## CHEESE SLICERS

The Kattex Cheese Slicers make light work of cutting through a variety of semi-soft cheeses, resulting in uniform cuts. Ideal for portion control and faster food prep.

- ◆ Cast aluminum construction with stainless steel wires
- ◆ Dimensions (closed): 13.2"L x 6.7"W x 4.5"H
- ◆ Cuts 3/8" or 3/4" cheese sticks, cubes or slices
- ◆ NSF listed

ITEM	DESCRIPTION	UOM	CASE
TCT-375	3/8" Blade Slicer	Each	1/4
TCT-375B	Replacement Bow for TCT-375	Set	1/10
TCT-750	3/4" Blade Slicer	Each	1/4
TCT-750B	Replacement Bow for TCT-750	Set	1/10



3/8" Slicing Blade

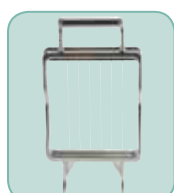

3/4" Slicing Blade



TCT-750



TCT-375

AVAILABLE IN MARCH 2018

## KATTEX CHEESE SLICERS

# KATTEX

TCT-SERIES

## ONION SLICERS

Just one smooth stroke of the Kattex Onion Slicer will produce evenly sliced coins of fruits and vegetables for salads or cocktail drinks.

- ◆ Aluminum construction with stainless steel wire blades
- ◆ Unique lever-handle allows for quick and easy operation
- ◆ Sturdy base with non-skid feet
- ◆ Two blades included can be stacked to create a finer cut
- ◆ 4-1/2" x 3-3/4" cutting area
- ◆ NSF listed

ITEM	DESCRIPTION	UOM	CASE
OS-188	3/16" Blade Slicer	Each	1/2
OS-250	1/4" Blade Slicer	Each	1/2

### ONION SLICER ACCESSORIES

ITEM	DESCRIPTION	UOM	CASE
OS-188B	3/16" Blade Set Assembly for OS-series (2 pieces)	Set	1/10
OS-250B	1/4" Blade Set Assembly for OS-series (2 pieces)	Set	1/10

## KATTEX ONION SLICERS

# KATTEX



Blade set assembly

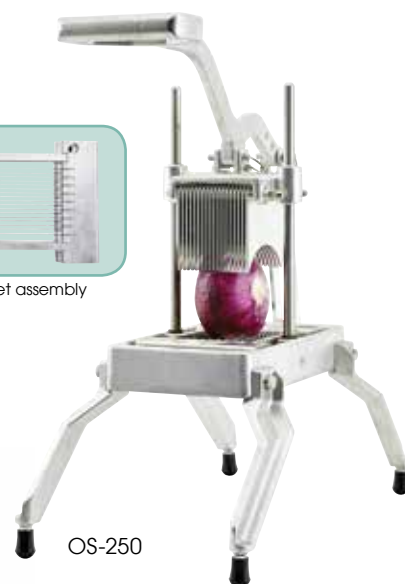

OS-250



OS-SERIES



## COMMERCIAL MANUAL CAN OPENERS



CO-3

**STAINLESS STEEL BLADE AND GEAR PORTABLE CLAMP INCLUDED**



CO-3 portable clamp

### PREMIUM MANUAL CAN OPENER

Our premium European-made heavy-duty nickel-plated can opener is fitted with a removable clamp, making it ideal for on-the-go operations that require flexibility. The rust-resistant stainless steel blade and gear opens various can sizes up to #10.

- ◆ Includes base, blade, gear and installation kit for mounting on wooden or stainless steel work tables

ITEM	DESCRIPTION	UOM	CASE
CO-3	Premium Manual Can Opener, Nickel Plated Steel Base	Each	1/12
CO-3B	1-Pc S/S Replacement Blade for CO-3	Each	1
CO-3G	1-Pc S/S Replacement Gear Set for CO-3	Each	1



CO-1

### STANDARD #1 MANUAL CAN OPENER

The go-to industry standard steel body can opener, made for heavy usage kitchen environments that require processing of up to 50 cans a day. Opens various can sizes up to #10.

- ◆ Includes base, blade, gear and installation kit for mounting on wooden or stainless steel work tables
- ◆ The extra-durable blade and gears are interchangeable with most other can opener brands

ITEM	DESCRIPTION	UOM	CASE
CO-1	Manual Can Opener, Cast Iron Body	Set	1
CO-1B	2-Pc Replacement Blade Set for CO-1	Set	24/288
CO-1G	1-Pc Replacement Gear Set for CO-1	Each	12/144

## FRENCH FRY CUTTERS



FFC-375



FFC-250B



FFC-250K



FFC-500P

### FRENCH FRY CUTTERS

- ◆ Made of heavy-duty cast iron and fitted with sharp stainless steel blades for even slicing
- ◆ Ergonomic handles makes for easy operating and sturdy legs provide stability on flat countertop surfaces

ITEM	DESCRIPTION	UOM	CASE
FFC-250	1/4" Cut	Each	1
FFC-375	3/8" Cut	Each	1
FFC-500	1/2" Cut	Each	1

### FRENCH FRY CUTTER ACCESSORIES

ITEM	DESCRIPTION	UOM	CASE
FFC-250B	Blade Assembly for FFC-250	Each	24
FFC-250K	Pusher Block for FFC-250	Each	24
FFC-375B	Blade Assembly for FFC-375	Each	24
FFC-375K	Pusher Block for FFC-375	Each	24
FFC-500B	Blade Assembly for FFC-500	Each	24
FFC-500K	Pusher Block for FFC-500	Each	24
FFC-500P	Pusher Support for FFC-Series	Each	12

## CONDIMENT DISPENSER

*Ideal for busy bars, food stands, convenient stores, or fast-food service. Removable plastic inserts allow for easy cleaning.*

- ◆ Durable 18/8 stainless steel
- ◆ Heavy-duty pump ideal for high-volume restaurant environment
- ◆ Two (2) plastic inserts, each with 2 quart capacity
- ◆ Each pump full stroke draws out between 1 oz and 1-1/4 oz depending on viscosity
- ◆ Overall dimensions: 11"L x 8-3/4"W x 16"H

ITEM	DESCRIPTION	UOM	CASE
PKTS-2D	Condiment Dispenser with 2 Standard Pumps	Set	1/2
PKTS-PT01	Individual Pump with Lid	Each	1
PKTS-PT02	Replacement Plastic Jar	Each	1
PKTS-PT03	Stainless Steel Casing	Each	1



## CONDIMENT DISPENSER



PKTS-2D

## TORTILLA PRESSES

- ◆ Traditional press with excellent leverage
- ◆ Integrated handle allows for easy open and removal of corn and flour tortillas
- ◆ Great for making burritos, enchiladas and quesadillas

ITEM	DESCRIPTION	WEIGHT	UOM	CASE
TPC-8A	8"Dia, Aluminum, Non-Stick	1.52Lbs	Each	6/12
TPC-8C	8"Dia, Cast Iron	7.94Lbs	Each	1/4



## TORTILLA PRESSES



NON-STICK TPC-8A

TPC-8C

## PASTA MAKER

*This pasta maker rolls out fresh sheets for building lasagnas and raviolis, strands of fettuccine and ribbons of pappardelle, all at the desired thickness from 2mm to 6mm.*

- ◆ Heavyweight chrome-plated stainless steel
- ◆ Clamps onto table or countertop for secure operation

ITEM	DESCRIPTION	UOM	CASE
NPM-7	Roller Length 7"	Set	1/6

## PASTA MAKER



HEAVY-WEIGHT

SECURELY CLAMPS ON TO TABLE OR COUNTERTOP

NPM-7

SCALES



SCAL-D20



DIGITAL PORTION CONTROL SCALE

Accurately weigh ingredients with measurements of either grams, pounds or ounces.

- ◆ Achieve consistency with portion control
- ◆ Ideal for quick-serve restaurant environment
- ◆ Removable stainless steel platform can be used as a tray
- ◆ Features auto-shutoff after three (3) minutes of inactivity
- ◆ Piece count, auto-zero and tare functions
- ◆ Battery and adapter included

ITEM	DESCRIPTION	CAPACITY	UOM	CASE
SCAL-D20	2-1/2 x 1" Digital Screen	20 Lb / 9 kg	Each	1/6



SCLH-2

SCLH-50



PREMIUM KITCHEN SCALES

- ◆ Heavy-duty stainless steel mechanical scale with 8" platform
- ◆ Shatter-proof lens protects dial
- ◆ Durable, corrosion-resistant

ITEM	DESCRIPTION	CAPACITY	GRADATIONS	UOM	CASE
SCLH-2	8" Dial	32 Oz	1/8 Oz / 10 g	Each	1/4
SCLH-50	8" Dial	50 Lb	1/8 Lb / 500 g	Each	1/4



SCAL-840



RECEIVING SCALES

- ◆ Sturdy construction with large steel platforms
- ◆ 8" and 9" scales are calibrated to Lbs as the base measurement

ITEM	DESCRIPTION	CAPACITY	GRADATIONS	UOM	CASE
SCAL-62	6.5" Dial	2 Lb / 1 kg	1/4 Oz / 5 g	Each	8
SCAL-66	6.5" Dial	6 Lb / 3 kg	1/2 Oz / 10 g	Each	8
SCAL-810	8" Dial	10 Lb / 4.55 kg	1 Oz / 25 g	Each	6
SCAL-820	8" Dial	20 Lb / 9.09 kg	1 Oz / 50 g	Each	6
SCAL-840	8" Dial	40 Lb / 18.18 kg	2 Oz / 100 g	Each	6
SCAL-960	9" Dial	60 Lb / 27.27 kg	4 Oz / 100 g	Each	2
SCAL-9100	9" Dial	100 Lb / 45.45 kg	4 Oz / 100 g	Each	2
SCAL-9130	9" Dial	130 Lb / 59.09 kg	8 Oz / 200 g	Each	2

SUPER-SIZE SALAD SPINNERS



PLSP-5O



PLSP-5G



SUPER-SIZE SALAD SPINNERS

- ◆ Constructed of FDA approved PP and ABS plastic, these spinners are equipped with side handles for safe transporting
- ◆ Foldable solid handle and 6 non-skid feet
- ◆ 3 tiers with 2 removable tier dividers that allow for various capacity configurations
- ◆ Dry 6 to 8 heads of lettuce in one minute!

ITEM	DESCRIPTION	UOM	CASE
PLSP-5G	5 Gal, Green	Each	1
PLSP-5O	5 Gal, Orange	Each	1



Comes apart for easy cleaning



PLSP-SERIES

### PREMIUM MANDOLINE SLICERS

- ◆ Rotary adjustment dial with 4 built-in blades for MDL-18
- ◆ Five (5) interchangeable blades for MDL-15
- ◆ Stainless steel body and handguard/food holder for each set

ITEM	DESCRIPTION	UOM	CASE
MDL-18	Mandoline Slicer Set, Built-in Blades	Set	1/8
MDL-15	Mandoline Slicer Set, Interchangeable Blades	Set	1/8
MDL-BLD	Blade Set for MDL-15	Set	12/48
MDL-HD	Hand Guard for MDL-15	Each	12/36



### MANDOLINE SLICERS



MDL-18

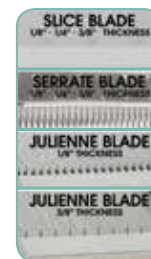

Built-in blade system for MDL-18



MDL-BLD



MDL-15



MDL-HD

### MANDOLINE SLICER SET

- ◆ Built-in julienne blades, also includes a reversible slice and serrated blade
- ◆ Non-skid folding stand for compact storage
- ◆ Rotary adjustment dial
- ◆ Plastic body with rubberized non-slip grip handguard

ITEM	DESCRIPTION	UOM	CASE
MDL-4P	Mandoline Slicer Set	Set	1/8



MDL-4P



Built-in blade system for MDL-4P

### JAPANESE MANDOLINE SLICER SET

*Slice vegetables and fruits effortlessly! The built-in blade is adjustable to desired thickness, and comes with fine, medium & coarse attachment blades.*

- ◆ Professional blades provide clean and sharp cuts
- ◆ Great for carrots, onions, cucumbers and more
- ◆ Hand guard included for safety

ITEM	DESCRIPTION	UOM	CASE
MDL-5P	Japanese Mandoline Slicer Set	Set	1/36
MDL-5PBS	Blade Set for MDL-5P	Set	1

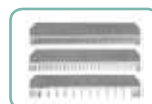

MDL-5PBC



MDL-5P





## SLICER & CHOPPER



VTS-3G



FCS-3

### TURNING SLICER

- ◆ Have beautiful vegetable strands and curly ribbons in minutes with a turn of the handle
- ◆ Perfect for garnishing, cooking, and making salads and coleslaws
- ◆ Includes plastic turner, built-in straight blade and 3 interchangeable julienne blades

ITEM	DESCRIPTION	UOM	CASE
VTS-3G	11"L x 5"W x 7-3/8"H	Each	1/12
VTS-3GBS	Serrated Blade Set for VTS-3G, 3-Pc: Coarse, Medium, Fine	Set	30

### FOOD CHOPPER

- ◆ 18/8 stainless steel construction with plastic base
- ◆ Zigzag-shaped blade rotates for dicing
- ◆ 0.5mm blade thickness

ITEM	DESCRIPTION	UOM	CASE
FCS-3	3" Dia	Each	6/24

## FOOD MILLS

*A great alternative to using a food processor, the Winco® stainless steel food mills are ideal for straining and puréeing cooked fruits and vegetables without retaining seeds, skin and fibers. Simply turn the crank and the semi-circular blade sweeps over, compresses and scrapes the food.*



SVM-12

### LARGE-SIZE FOOD MILL

- ◆ Comes with five (5) cutting plates for a variety of textures
- ◆ The cutting plates are interchangeable with round perforations 8mm, 4mm, 3mm or 2mm dia, and 3 x 8.5mm rectangular grates
- ◆ Output is approximately 3 lbs per minute and fits on any 7" or larger receptacle

ITEM	DESCRIPTION	SIZE	UOM	CASE
SVM-12	5 Qt	12-3/4"Dia	Set	1/4

### MEDIUM-SIZE STAINLESS STEEL FOOD MILLS

ITEM	DESCRIPTION	SIZE	UOM	CASE
SVM-8	2 Qt w/4 Graters	8"Dia	Set	1/8
SVM-9	2 Qt w/3 Graters	9"Dia	Set	1/6



SVM-8



SVM-9

**APPLE PEELER**

*This apple peeler is about efficiency and volume. Turn the handle and it quickly peels, slices and cores apples all at the same time.*

- ◆ Cast aluminum body with sharp stainless steel blade
- ◆ Vacuum base holds peeler securely to any smooth surface
- ◆ Also ideal for pears, onions and potatoes

ITEM	DESCRIPTION	UOM	CASE
AP-12	10"L x 6"W x 4-1/4"H	Set	1/12

**PEELER & SQUEEZERS**



AP-12

**TABLETOP JUICE SQUEEZERS**

ITEM	DESCRIPTION	UOM	CASE
JC-16	Heavy-duty, 15"	Each	1/6
JC-19	Premium, 19"	Each	1/2



JC-19

JC-16

**MARBLE MORTAR & PESTLE SET**

ITEM	DESCRIPTION	UOM	CASE
MPS-42W	4-1/2"Dia Bowl	Set	1/12

**MORTAR & PESTLE**



MPS-42W

## STAINLESS STEEL MIXING BOWLS



MXHV-500



MXBH-500



MXBT-500Q



MXB-500Q



MXRU-SERIES



SMB-SERIES



MXBS-30

## HEAVY-DUTY MIXING BOWLS

ITEM	DESCRIPTION	SIZE (DIA X DEPTH)	UOM	CASE
MXHV-75	3/4 Qt	6-1/4" x 1-3/4"	Each	12/72
MXHV-150	1-1/2 Qt	7-3/4" x 2-1/4"	Each	12/36
MXHV-300	3 Qt	9-7/8" x 3"	Each	12/24
MXHV-400	4 Qt	10-5/8" x 3-1/4"	Each	12/24
MXHV-500	5 Qt	11-5/8" x 3-3/8"	Each	6/12
MXHV-800	8 Qt	13-3/4" x 5"	Each	6/12
MXHV-1300	13 Qt	16-1/4" x 4-1/2"	Each	12
MXHV-1600	16 Qt	17-3/4" x 5-1/2"	Each	12
MXHV-2000	20 Qt	18-3/4" x 5"	Each	12

## DEEP MIXING BOWLS

ITEM	DESCRIPTION	SIZE (DIA X DEPTH)	UOM	CASE
MXBH-300	3 Qt	9" x 3-1/2"	Each	12/48
MXBH-500	5 Qt	10-1/4" x 4-1/2"	Each	12/36
MXBH-800	8 Qt	12" x 5"	Each	12/24
MXBH-1300	13 Qt	15" x 5-3/4"	Each	12

## ALL-PURPOSE MIXING BOWLS

◆ True capacity for all-purpose kitchen prep work

ITEM	DESCRIPTION	SIZE (DIA X DEPTH)	UOM	CASE
MXBT-75Q	3/4 Qt	6-3/8" x 2-3/8"	Each	12/144
MXBT-150Q	1-1/2 Qt	7-7/8" x 2-7/8"	Each	12/144
MXBT-300Q	3 Qt	10-1/4" x 3-5/8"	Each	12/72
MXBT-400Q	4 Qt	11" x 3-3/4"	Each	12/72
MXBT-500Q	5 Qt	11-7/8" x 4"	Each	12/72
MXBT-800Q	8 Qt	13-3/4" x 5"	Each	12/36
MXBT-1300Q	13 Qt	16-3/8" x 5-7/8"	Each	12/24
MXBT-1600Q	16 Qt	17-7/8" x 6"	Each	12
MXBT-2000Q	20 Qt	19" x 6-5/8"	Each	12

## ECONOMY MIXING BOWLS

ITEM	DESCRIPTION	SIZE (DIA X DEPTH)	UOM	CASE
MXB-75Q	3/4 Qt	6-1/4" x 1-3/4"	Each	12/144
MXB-150Q	1-1/2 Qt	7-3/4" x 2-1/2"	Each	12/144
MXB-300Q	3 Qt	9-1/2" x 3-1/2"	Each	12/72
MXB-400Q	4 Qt	10-5/8" x 3-1/2"	Each	12/72
MXB-500Q	5 Qt	11-1/2" x 3-1/2"	Each	12/72
MXB-800Q	8 Qt	13-1/4" x 4-1/8"	Each	12/36
MXB-1300Q	13 Qt	14-3/4" x 3-1/2"	Each	24
MXB-1600Q	16 Qt	17-3/4" x 5"	Each	12
MXB-2000Q	20 Qt	18-5/8" x 5-1/2"	Each	12
MXB-3000Q	30 Qt	22-1/2" x 7-1/2"	Each	12

## SILICONE BASE MIXING BOWLS

◆ Non-skid silicone base helps to keep bowl in place during mixing and prepping

ITEM	DESCRIPTION	SIZE (DIA X DEPTH)	UOM	CASE
MXRU-150	1-1/2 Qt	6-3/4" x 3-3/4"	Each	48
MXRU-300	3 Qt	8-1/2" x 4-3/8"	Each	24
MXRU-500	5 Qt	10-1/4" x 5-5/8"	Each	24
MXRU-800	8 Qt	11-3/4" x 6-1/2"	Each	6/12

## STAINLESS STEEL MEASURING BOWLS

◆ With interior graduations

ITEM	DESCRIPTION	UOM	CASE
SMB-4	4 Cups	Each	48
SMB-6	6 Cups	Each	24
SMB-10	10 Cups	Each	24

## MIXING BOWL STAND

ITEM	DESCRIPTION	UOM	CASE
MXBS-30	Stand for MXB-3000Q	Set	1
MXBS-30-C	Caster for MXBS-30	Each	4/24

## HEAVY-DUTY COLANDERS

- ◆ Use to wash or drain large fruits, vegetables, pastas & meats
- ◆ Medium-size holes allow water to flow freely
- ◆ Premium quality stainless steel, extra deep with a wide base
- ◆ Extra heavy-duty weight

ITEM	DESCRIPTION	SIZE (DIA X DEPTH)	UOM	CASE
SLO-11	11 Qt	15" x 7-1/2"	Each	1
SLO-16	16 Qt	16-1/2" x 7-1/2"	Each	1

## COLANDERS



SLO-16

## ALL-PURPOSE COLANDERS

- ◆ Stainless steel

ITEM	DESCRIPTION	SIZE (DIA X DEPTH)	UOM	CASE
COD-3	3 Qt	10" x 4"	Each	12/48
COD-5	5 Qt	11-5/8" x 4"	Each	24
COD-8	8 Qt	13-1/4" x 5-1/8"	Each	12
COD-14	14 Qt	16-1/4" x 5-7/8"	Each	12



COD-3

## CHINESE STYLE COLANDERS

- ◆ Stainless steel

ITEM	DESCRIPTION	SIZE (DIA X DEPTH)	UOM	CASE
CCOD-11L	Coarse	11-3/4" x 4"	Each	24
CCOD-13L	Coarse	14-1/8" x 4-3/4"	Each	24
CCOD-15L	Coarse	16-3/8" x 5-1/8"	Each	12
CCOD-11S	Fine	12" x 4"	Each	24
CCOD-13S	Fine	15" x 4-1/2"	Each	24
CCOD-15S	Fine	16-3/8" x 5-1/2"	Each	12



CCOD-15L

CCOD-11S

## COLANDERS WITH BASE

- ◆ Aluminum

ITEM	DESCRIPTION	SIZE (DIA X DEPTH)	UOM	CASE
ALO-8BH	8 Qt	12" x 5"	Each	6
ALO-11BH	11 Qt	15" x 5-3/4"	Each	6
ALO-16BH	16 Qt	16-1/2" x 7-1/8"	Each	4



ALO-16BH

## CHINESE-STYLE COLANDERS

- ◆ Aluminum

ITEM	DESCRIPTION	SIZE (DIA X DEPTH)	UOM	CASE
ALO-12	12 Qt	13-1/2" x 5-1/2"	Each	12
ALO-16	16 Qt	16" x 8"	Each	12
ALO-16H	16 Qt	16-1/8" x 8"	Each	6



ALO-12

ALO-16H



# THERMOMETERS

**NSF** TMT-SERIES

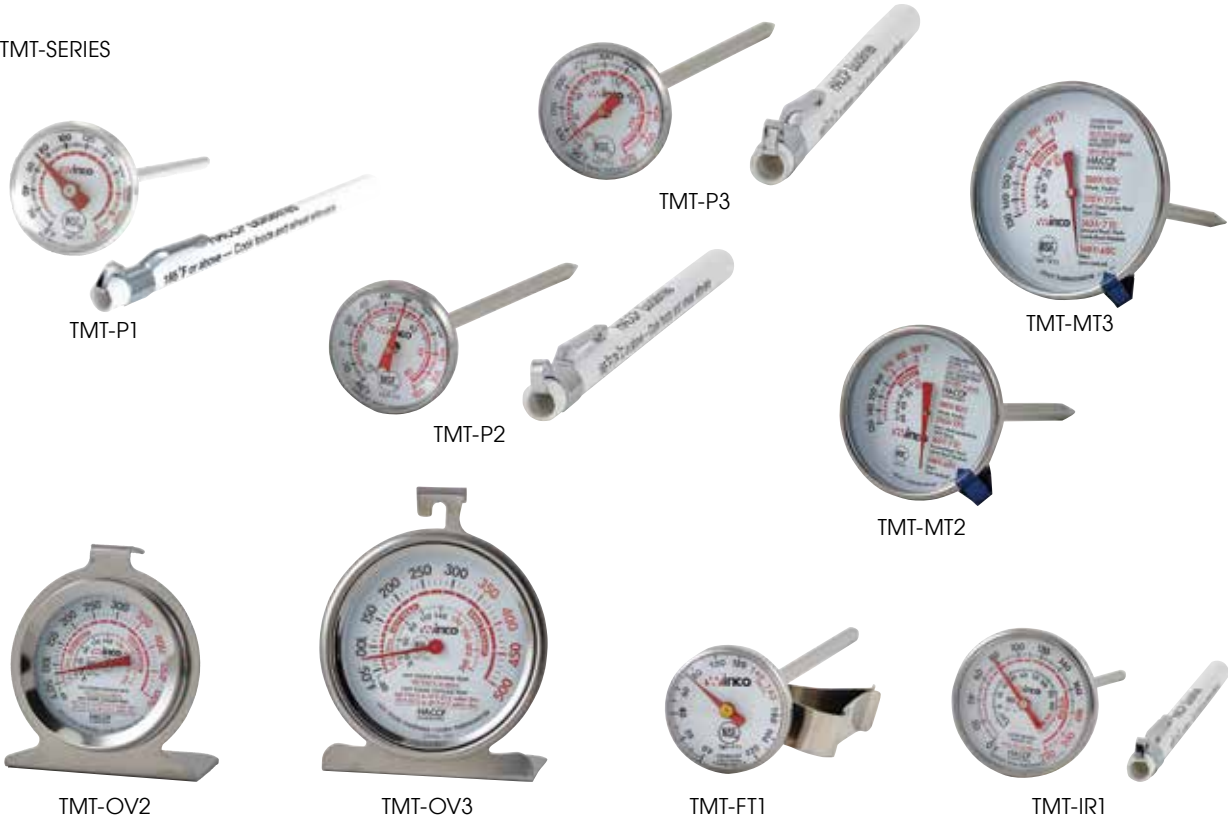

## POCKET TEST

- ◆ Built-in clip on the protective sleeve
- ◆ Comes with protective sheath

ITEM	NSF	TEMPERATURE RANGE	DIAL FACE SIZE	PROBE LENGTH	GUIDELINE ON DIAL	UOM	CASE
TMT-P1		0-220°F; -18-104°C	1" Dia	5"	HACCP	Each	12/72
TMT-P2		-40-180°F; -40-80°C	1" Dia	5"	HACCP	Each	12/72
TMT-P3		50-550°F; 10-288°C	1" Dia	5"	HACCP	Each	12/144

## MEAT

- ◆ Hand held thermometer
- ◆ Optional versions of the thermometer have adjustable indicators

ITEM	NSF	TEMPERATURE RANGE	DIAL FACE SIZE	PROBE LENGTH	GUIDELINE ON DIAL	UOM	CASE
TMT-MT2		130-190°F; 55-85°C	2" Dia	5"	HACCP	Each	12/144
TMT-MT3		130-190°F; 55-85°C	3" Dia	5"	HACCP	Each	12/72

## OVEN

- ◆ Hanging hook and standing panel are built-in

ITEM	NSF	TEMPERATURE RANGE	DIAL FACE SIZE	GUIDELINE ON DIAL	UOM	CASE
TMT-OV2		40-500°F; 10-260°C	2" Dia	HACCP	Each	12/144
TMT-OV3		40-500°F; 10-260°C	3" Dia	HACCP	Each	12/144

## FROTHING

- ◆ Includes pot clip
- ◆ Can be calibrated

ITEM	NSF	TEMPERATURE RANGE	DIAL FACE SIZE	PROBE LENGTH	OC AVAILABLE	UOM	CASE
TMT-FT1		0-220°F	1" Dia	5"	Optional	Each	12/144

## INSTANT READ

- ◆ Built-in clip on the protective sleeve
- ◆ Can be calibrated

ITEM	NSF	TEMPERATURE RANGE	DIAL FACE SIZE	PROBE LENGTH	GUIDELINE ON DIAL	UOM	CASE
TMT-IR1		0-220°F; -18-104°C	1-3/4" Dia	5"	HACCP	Each	12/72

TMT-SERIES  



TMT-DG6



TMT-GS2



TMT-CDF2



TMT-CDF3



TMT-CDF5



TMT-RF1



TMT-RF2



TMT-RF3



TMT-RF4



TMT-CDF4

**ROAST/MEAT**

- ◆ Programmable timer and temperatures
- ◆ Flip-down stand
- ◆ Magnet included

ITEM	NSF	TEMPERATURE RANGE	DIAL FACE SIZE	PROBE LENGTH	GUIDELINE ON DIAL	UOM	CASE
TMT-DG6		-58-572°F; -50-300°C	1-7/8" Digital LCD	6"		Set	24/96

**GRILL FACE**

- ◆ Flat surface for grill-top



ITEM	NSF	TEMPERATURE RANGE	DIAL FACE SIZE	UOM	CASE
TMT-GS2		150-700°F; 70-370°C	2" Dia	Each	3/144

**CANDY/DEEP FRYER**

- ◆ Pot clip included

ITEM	NSF	TEMPERATURE RANGE	DIAL FACE SIZE	PROBE LENGTH	GUIDELINE ON DIAL	OTHER FEATURES	UOM	CASE
TMT-CDF2		100-400°F; 40-200°C	2" Dia	5"	HACCP	Adjustable indicator	Each	12/144
TMT-CDF3		100-400°F; 40-200°C	2" Dia	12"	HACCP	Adjustable indicator	Each	12/144
TMT-CDF4		100-400°F; 40-200°C	2" x 11-3/4"	N/A	N/A	Top hanging	Each	12/72
TMT-CDF5		100-500°F; 40-260°C	3" Dia	12"	HACCP	Adjustable indicator	Each	6/36

**REFRIGERATOR/FREEZER**

ITEM	NSF	TEMPERATURE RANGE	DIAL FACE SIZE	GUIDELINE ON DIAL	MOUNTING	UOM	CASE
TMT-RF1		-26-86°F; -30-30°C	2-7/8" x 5/8"	N/A	Suction cup (included)	Pack	12/144
TMT-RF2		-20-70°F; -30-21°C	2" Dia	HACCP	Hanging hook & standing panel (built-in)	Each	12/72
TMT-RF3		-20-70°F; -30-21°C	3" Dia	HACCP	Hanging hook & standing panel (built-in)	Each	12/72
TMT-RF4		-20-80°F; -28-26°C	3-1/2" x 1-1/8"	HACCP	Suction cup (included)	Each	12/72

## THERMOMETERS

**NSF** TMT-SERIES

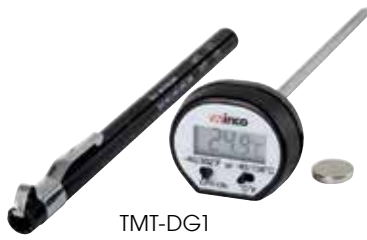

TMT-DG1



TMT-DG2



TMT-DG4



TMT-DG5



TMT-WD1



TMT-IF1

### DIGITAL

- ◆ Comes with protective sleeve
- ◆ Excellent, quick response times for fast temperature readings

ITEM	NSF	TEMPERATURE RANGE	DIAL FACE SIZE	PROBE LENGTH	GUIDELINE ON DIAL	MOUNTING / OTHER FEATURES	UOM	CASE
TMT-DG1		-40-302°F; -40-150°C	1" LCD (Diagonal)	4-3/4"	Meat Cooking Temperature Guide		Each	12/144
TMT-DG2		-49-392°F; -45-200°C	1-3/16" LCD	4-3/4"	Meat Cooking Temperature Guide	Head swivels 180 degrees for easy reading	Each	12/72
TMT-DG4		-40-450°F; -40-230°C	1-1/4" LCD	3-1/8"	HACCP	Hold function	Each	3/144
TMT-DG5		-49-392°F; -45-200°C	1-3/8" LCD with Back Light	2-7/8"	Meat Cooking Temperature Guide	<ul style="list-style-type: none"> <li>• Min &amp; max feature</li> <li>• Hold function</li> <li>• Hanging string</li> </ul>	Each	12/72

### WATERPROOF DIGITAL THERMOMETER

- ◆ Compact pen-style thermometer provides fast temperature readings for liquids or solids
- ◆ Minimum & maximum feature

ITEM	NSF	TEMPERATURE RANGE	DIAL FACE SIZE	PROBE LENGTH	GUIDELINE ON DIAL	MOUNTING / OTHER FEATURES	UOM	CASE
TMT-WD1		-58-392°F; -50-200°C	7/8" LCD	2-3/4"		<ul style="list-style-type: none"> <li>• Hold function</li> <li>• Includes protective sleeve</li> </ul>	Each	24/96

### INFRARED THERMOMETER

- ◆ Simply point infrared light at surface for accurate temperature reading of all kinds of cooked or baked goods, without the risk of cross-contamination.
- ◆ 20 second automatic power off
- ◆ Distance spot ratio 12:1

ITEM	NSF	TEMPERATURE RANGE	DIAL FACE SIZE	PROBE LENGTH	GUIDELINE ON DIAL	MOUNTING / OTHER FEATURES	UOM	CASE
TMT-IF1		-26°F-608°F; -32°C-320°C	1" LCD with Back Light	N/A		<ul style="list-style-type: none"> <li>• Auto temp. hold</li> <li>• Laser ON/OFF</li> </ul>	Each	12/48

## STATIK BOARD™ CUTTING BOARDS

The patented original design of STATIK BOARD™ puts safety first with molded-through, non-slip feet that prevent slipping & sliding, even on wet countertops. Rubberized sides of the board help maintain an upright storage position without sliding. They hold firm, are sturdy, and the fully-rubberized hook makes them easy to store and transport.

- ◆ Built-in hook for easy transport and hygienic storage
- ◆ Rubberized feet grip flat surfaces; rubberized sides keep the board upright without sliding
- ◆ Available in three (3) popular sizes
- ◆ HACCP color-coding system to minimize cross-contact
- ◆ Tough board surface reduces knife dulling; durable co-polymer prevents warping
- ◆ Dishwasher safe
- ◆ NSF listed

ITEM	DESCRIPTION	COLOR	UOM	CASE
CBN-1218BN	12" x 18" x 1/2"	Brown	Each	6
CBN-1218BU	12" x 18" x 1/2"	Blue	Each	6
CBN-1218GR	12" x 18" x 1/2"	Green	Each	6
CBN-1218PP	12" x 18" x 1/2"	Purple	Each	6
CBN-1218RD	12" x 18" x 1/2"	Red	Each	6
CBN-1218WT	12" x 18" x 1/2"	White	Each	6
CBN-1218YL	12" x 18" x 1/2"	Yellow	Each	6
CBN-1520BN	15" x 20" x 1/2"	Brown	Each	6
CBN-1520BU	15" x 20" x 1/2"	Blue	Each	6
CBN-1520GR	15" x 20" x 1/2"	Green	Each	6
CBN-1520PP	15" x 20" x 1/2"	Purple	Each	6
CBN-1520RD	15" x 20" x 1/2"	Red	Each	6
CBN-1520WT	15" x 20" x 1/2"	White	Each	6
CBN-1520YL	15" x 20" x 1/2"	Yellow	Each	6
CBN-1824BN	18" x 24" x 1/2"	Brown	Each	6
CBN-1824BU	18" x 24" x 1/2"	Blue	Each	6
CBN-1824GR	18" x 24" x 1/2"	Green	Each	6
CBN-1824PP	18" x 24" x 1/2"	Purple	Each	6
CBN-1824RD	18" x 24" x 1/2"	Red	Each	6
CBN-1824WT	18" x 24" x 1/2"	White	Each	6
CBN-1824YL	18" x 24" x 1/2"	Yellow	Each	6

## STATIK BOARD™ CUTTING BOARDS



# STATIKboard™

NEW & IMPROVED DESIGN



CBN-SERIES

NSF

BPA FREE

EDGES OF THE NON-SLIP FEET HELP PREVENT BOARDS FROM SLIDING WHEN STORED VERTICALLY WITHOUT RACKS



## CUTTING BOARDS & MATS

NSF

BPA FREE

CBWT-SERIES



NSF

BPA FREE

CBI-SERIES



CBI-1520

NSF

BPA FREE

CBF-SERIES



WCB-125

WCB-1824

AVAILABLE IN  
FEBRUARY 2018

NEW



WCB-225



### WHITE RECTANGULAR CUTTING BOARDS

◆ NSF listed

ITEM	DESCRIPTION	UOM	CASE
CBWT-610	6" x 10" x 1/2"	Each	20
CBWT-1218	12" x 18" x 1/2"	Each	6
CBWT-1520	15" x 20" x 1/2"	Each	6
CBWT-1824	18" x 24" x 1/2"	Each	6
CBWT-1830	18" x 30" x 1/2"	Each	6
CBH-1218	12" x 18" x 3/4"	Each	6
CBH-1520	15" x 20" x 3/4"	Each	6
CBH-1824	18" x 24" x 3/4"	Each	6
CBXH-1218	12" x 18" x 1"	Each	4
CBXH-1520	15" x 20" x 1"	Each	4
CBXH-1824	18" x 24" x 1"	Each	4



### WHITE GROOVED CUTTING BOARDS

◆ Higher efficiency in food prep without worrying about juice spillage

◆ NSF listed

ITEM	DESCRIPTION	UOM	CASE
CBI-1218	12" x 18" x 1/2"	Each	6
CBI-1520	15" x 20" x 1/2"	Each	6
CBI-1824	18" x 24" x 1/2"	Each	6
CBI-1824H	18" x 24" x 3/4"	Each	6



### WHITE FLEXIBLE CUTTING MATS

◆ Mat flexes to easily transport food to cookware or storage

◆ 1/16" thick polyethylene; will not crack or chip

◆ Safe, hygienic and easy to clean

◆ NSF listed

ITEM	DESCRIPTION	UOM	CASE
CBF-1520W	15" x 20", 6-Pcs/Set	Set	12

*Keep away from open flame. Do not put hot pans on top of mats. Wash with warm soapy water.*

### WOODEN CUTTING BOARDS

◆ 1-3/4" thick durable hardwood

ITEM	DESCRIPTION	UOM	CASE
WCB-1218	12" x 18"	Each	1/2
WCB-1520	15" x 20"	Each	1/2
WCB-1824	18" x 24"	Each	1
WCB-1830	18" x 30"	Each	1

### WOODEN BREAD/CHEESE BOARDS

ITEM	DESCRIPTION	UOM	CASE
WCB-125	12" x 5" x 3/4"	Each	24
WCB-225	22-1/2"L x 5-1/2"W x 3/4"H	Each	12

## CUTTING BOARD RACKS



CB-6K



CB-6L



### CUTTING BOARD RACKS

◆ Fits cutting boards up to 1" thick

ITEM	DESCRIPTION	UOM	CASE
CB-6L	6 Slots, Chrome Plated	Each	6/12
CB-6K	6 Slots, Vinyl Coated	Each	10

### ALLERGEN-FREE COLOR-CODED CUTTING BOARD

Solve the challenges of maintaining an allergen-aware kitchen! Improve customer dining experiences & raise the bar for food safety. Prevent cross-contaminating allergens with the extensive line of Allergen-Free tools by Winco®. Whether it's gluten or nuts, use this stand-out purple color to designate the cutting board as allergen-free.

◆ NSF listed

ITEM	DESCRIPTION	COLOR	UOM	CASE
CBPP-1218	12" x 18" x 1/2"	Purple	Each	6

### CUTTING BOARDS & MATS



CBPP-1218

NSF

BPA FREE

### HAACP COLOR-CODED CUTTING BOARDS

◆ NSF listed

ITEM	DESCRIPTION	COLOR	UOM	CASE
CBBN-1218	12" x 18" x 1/2"	Brown	Each	6
CBBU-1218	12" x 18" x 1/2"	Blue	Each	6
CBGR-1218	12" x 18" x 1/2"	Green	Each	6
CBRD-1218	12" x 18" x 1/2"	Red	Each	6
CBYL-1218	12" x 18" x 1/2"	Yellow	Each	6
CBBN-1520	15" x 20" x 1/2"	Brown	Each	6
CBBU-1520	15" x 20" x 1/2"	Blue	Each	6
CBGR-1520	15" x 20" x 1/2"	Green	Each	6
CBRD-1520	15" x 20" x 1/2"	Red	Each	6
CBYL-1520	15" x 20" x 1/2"	Yellow	Each	6
CBBN-1824	18" x 24" x 1/2"	Brown	Each	6
CBBU-1824	18" x 24" x 1/2"	Blue	Each	6
CBGR-1824	18" x 24" x 1/2"	Green	Each	6
CBRD-1824	18" x 24" x 1/2"	Red	Each	6
CBYL-1824	18" x 24" x 1/2"	Yellow	Each	6



COLORED CUTTING BOARDS

NSF

BPA FREE

STANDARD COLOR CODING SYSTEM		
Raw Meats	Raw Poultry	Vegetable & Fruit
Bakery & Dairy	Cooked Meats	Seafood

### HAACP COLOR-CODED FLEXIBLE CUTTING MATS

- ◆ Mat flexes to easily transport food to cookware or storage
- ◆ Safe, easy to clean and complies with color coding standards for food preparation hygiene
- ◆ Made of 1/16" thick polyethylene; will not crack or chip
- ◆ Six (6) assorted colors included in set
- ◆ NSF listed

ITEM	DESCRIPTION	COLOR	UOM	CASE
CBF-1218	12" x 18"	Assorted	Set	12
CBF-1520	15" x 20"	Assorted	Set	12
CBF-1824	18" x 24"	Assorted	Set	6

Keep away from open flame. Do not put hot pans on top of mats. Wash with warm soapy water.



CBF-SERIES

NSF

BPA FREE

### HAACP COLOR-CODED CUTTING BOARD SETS

- ◆ Six (6) assorted colors included in set
- ◆ NSF listed

ITEM	DESCRIPTION	COLOR	UOM	CASE
CBST-1218	12" x 18" x 1/2"	Assorted	Set	1
CBST-1520	15" x 20" x 1/2"	Assorted	Set	1
CBST-1824	18" x 24" x 1/2"	Assorted	Set	1



CBST-SERIES

NSF

BPA FREE

### HAACP COLOR-CODED CUTTING BOARD BRUSHES

ITEM	DESCRIPTION	COLOR	UOM	CASE
CBR-WT	6-1/2"L x 2-1/2"W	White	Each	24/96
CBR-BN	6-1/2"L x 2-1/2"W	Brown	Each	24/96
CBR-BU	6-1/2"L x 2-1/2"W	Blue	Each	24/96
CBR-GR	6-1/2"L x 2-1/2"W	Green	Each	24/96
CBR-RD	6-1/2"L x 2-1/2"W	Red	Each	24/96
CBR-YL	6-1/2"L x 2-1/2"W	Yellow	Each	24/96

### CUTTING BOARD BRUSHES



CBR-SERIES

## BATTER DISPENSERS



APCD-6



APCD-6 & APCD-6R



APCD-6R



STN-3



SF-7



SF-7 & SF-7R

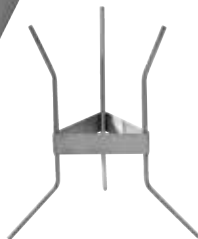

SF-7R



### ALUMINUM PANCAKE DISPENSER

- ◆ Durable plunger ensures consistent amounts of batter every time
- ◆ Eight portion-control settings ranging from 1/2 oz to 8 oz
- ◆ 10 gauge high-grade aluminum body
- ◆ Parts are durable, long-lasting, and prevent clogs and leaking

ITEM	DESCRIPTION	UOM	CASE
APCD-6	Pancake Dispenser	Each	1/6
APCD-6R	Rack for APCD-6	Each	12/48



### PANCAKE TURNER

- ◆ Heat resistant up to 608°F (320°C)
- ◆ Nylon blade
- ◆ 18/8 stainless steel handle

ITEM	DESCRIPTION	UOM	CASE
STN-3	15-7/16"L x 5-15/16"W x 2-13/16"H	Each	24/48

### CONFECTIONERY FUNNEL

- ◆ Use to dispense a smooth flow of fondant, syrup or prepared creams
- ◆ Spring valve feature allows for easy control with single-handed operation
- ◆ Comes with three (3) nozzles: 4mm, 5mm, 6mm
- ◆ Rack sold separately

ITEM	DESCRIPTION	UOM	CASE
SF-7	Funnel, S/S	Each	1/8
SF-7R	Rack for SF-7, S/S	Each	1/24

## UTILITY PAIL



UP-13

### UTILITY PAIL

- ◆ Stainless steel

ITEM	DESCRIPTION	UOM	CASE
UP-13	13 Qt	Each	12

# Allergen Free

FOR THE ALLERGEN-AWARE KITCHEN

## Raise the bar on food safety

Maintain the purity of your ingredients with Winco's extensive collection of Allergen-Free prep-tools, serveware, cutlery, storage containers and more.

**Purple** colored tools allow for quick and easy identification to prevent cross-contact and ensure allergen-safe food preparation. Safe-guard your guests with Allergen-Free!

ALLERGEN-FREE

### ALLERGEN-FREE PURPLE SILICONE BAKING MATS

- ◆ Double-sided and reusable up to 2,000 times
- ◆ Provides consistent and even heat distribution
- ◆ Woven fiberglass coated with food-grade silicone
- ◆ Temperature tolerance from -40°F to 480°F

ITEM	DESCRIPTION	SIZE	UOM	CASE
SBS-11PP	1/4-Size	8-1/4" x 11-3/4"	Each	20/100
SBS-16PP	1/2-Size	11-5/8" x 16-1/2"	Each	10/50
SBS-21PP	2/3-Size	14-7/16" x 20-1/2"	Each	10/50
SBS-24PP	Full-Size	16-3/8" x 24-1/2"	Each	10/50



SBS-21PP

### ALLERGEN-FREE DOUGH SCRAPERS

ITEM	DESCRIPTION	SIZE	UOM	CASE
DSC-2P	Dough Scraper, Plstc Hdl, S/S Blade	6" x 3"	Each	12/72
PDS-7P	Plastic Dough Scrapers, 6pcs/pk	7-1/2" x 4-3/4"	Pack	24/48



DSC-2P



PDS-7P



### ALLERGEN-FREE COLOR CODED SCRAPER

- ◆ Features raised ridges for resting to prevent messy counters
- ◆ Heat-resistant up to 600°F (315°C)

ITEM	DESCRIPTION	UOM	CASE
PSH-10P	10-1/2"	Each	24/144
PSH-14P	14"	Each	24/144
PSH-16P	16-1/4"	Each	24/144



PSH-16P

### ALLERGEN-FREE CUTTING BOARDS

*The patented original design of STATIK BOARD™ puts safety first with molded-through, non-slip feet that prevent slipping & sliding, even on wet countertops. Rubberized sides of the board help maintain an upright storage position without sliding. They hold firm, are sturdy, and the fully-rubberized hook makes them easy to store and transport.*

- ◆ Built-in hook for easy transport and hygienic storage
- ◆ Rubberized feet grip flat surfaces; rubberized sides keep the board upright without sliding
- ◆ Available in 3 popular sizes
- ◆ HACCP color-coding system to minimize cross-contact
- ◆ Tough board surface reduces knife dulling; durable co-polymer prevents warping
- ◆ Dishwasher safe
- ◆ NSF listed

ITEM	DESCRIPTION	COLOR	UOM	CASE
CBN-1218PP	12" x 18" x 1/2"	Purple	Each	6
CBN-1520PP	15" x 20" x 1/2"	Purple	Each	6
CBN-1824PP	18" x 24" x 1/2"	Purple	Each	6
CBPP-1218	12" x 18" x 1/2"	Purple	Each	6

STATIK board™



CBN-1824PP

CBPP-1218



CUTTING BOARDS





**ALLERGEN-FREE KITCHEN TOOLS**



BFM-A100



PECC-128P, PECC-68P, PECC-24P

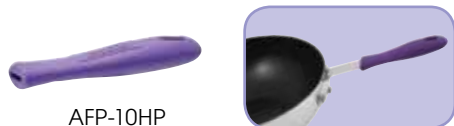

AFP-10HP

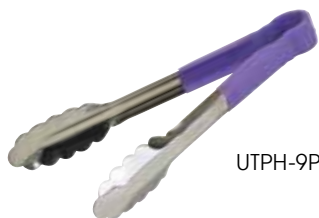

UTPH-9P



LDC-4P



FPS-4P

FPP-4P



ICD-16P



**ALLERGEN-FREE BAMBOO FOOD MARKERS**

- ◆ Label and organize dishes that contain no allergens
- ◆ Each pack contains 100 pieces

ITEM	DESCRIPTION	UOM	CASE
BFM-A100	Food Markers	Pack	20/200

**ALLERGEN-FREE COVERS**

- ◆ Compatible with PCSC, PTSC, and PESC Series

ITEM	DESCRIPTION	COLOR	UOM	CASE
PECC-24P	Fits 2 Qt & 4 Qt	Purple	Each	12
PECC-68P	Fits 6 Qt & 8 Qt	Purple	Each	12
PECC-128P	Fits 12 Qt, 18 Qt, 22 Qt	Purple	Each	6

**ALLERGEN-FREE SILICONE SLEEVE**

ITEM	DESCRIPTION	COLOR	UOM	CASE
AFP-10HP	Fits AFP-10, ASFP-11, ASP-3, -4	Purple	Each	1/120

**ALLERGEN-FREE STAINLESS STEEL UTILITY TONGS**

- ◆ Non-slip comfort grip PP handle, heat resistant up to 220°F
- ◆ Made in Korea

ITEM	DESCRIPTION	UOM	CASE
UTPH-9P	9"	Each	6/72
UTPH-12P	12"	Each	6/72
UTPH-16P	16"	Each	6/72

**ALLERGEN-FREE STAINLESS STEEL ONE-PIECE LADLES**

ITEM	DESCRIPTION	HANDLE	UOM	CASE
LDC-2P	2 Oz	12-1/2"	Each	12/120
LDC-4P	4 Oz	15-1/2"	Each	12/120
LDC-6P	6 Oz	15-1/2"	Each	12/120

**ALLERGEN-FREE STAINLESS STEEL ONE-PIECE FOOD PORTIONERS**

ITEM	DESCRIPTION	UOM	CASE
FPS-2P	2 Oz, Solid	Each	12/72
FPS-4P	4 Oz, Solid	Each	12/72
FPS-6P	6 Oz, Solid	Each	12/72
FPP-2P	2 Oz, Perforated	Each	12/72
FPP-4P	4 Oz, Perforated	Each	12/72
FPP-6P	6 Oz, Perforated	Each	12/72



**ALLERGEN-FREE STAINLESS STEEL DISHERS**

- ◆ NSF listed

ITEM	DESCRIPTION	SIZE	UOM	CASE
ICD-10P	3-3/4 Oz, 2-5/8"Dia	10"	Each	1/36
ICD-12P	3-1/4 Oz, 2-1/2"Dia	12"	Each	1/36
ICD-16P	2-3/4 Oz, 2-1/4"Dia	16"	Each	1/36
ICD-20P	2 Oz, 2-1/8"Dia	20"	Each	1/36

**ALLERGEN-FREE STAINLESS STEEL TURNERS & SPATULAS**

- ◆ Ergonomic handle with slip-free grip reduces hand fatigue
- ◆ Satin finish
- ◆ NSF listed

ITEM	DESCRIPTION	BLADE	UOM	CASE
TWP-31P	Sandwich Spreader	3-5/8" x 1-1/4"	Each	12/144
TWP-42P	Turner, Offset	8" x 4"	Each	12/48
TWP-51P	Pie Server, Offset *	4-5/8" x 2-3/8"	Each	12/72
TWP-60P	Fish Spatula	6-3/4" x 3-1/4"	Each	12/144
TWP-61P	Hamburger Turner, Offset*	5-1/8" x 2-7/8"	Each	12/72
TWP-90P	Flexible Turner, Offset*	8-1/4" x 2-7/8"	Each	12/48
TWP-91P	Perf Flex Turner, Offset*	8-1/4" x 2-7/8"	Each	12/48
TWPO-9P	Spatula, Offset*	8-1/2" x 1-1/2"	Each	12/72
TWPS-9P	Bakery Spatula	10" x 1-3/8"	Each	12/72

\*Measurement reflects blade size not including offset



**ALLERGEN-FREE KITCHEN TOOLS**



TWP, TWPO & TWPS-SERIES **NSF**

**ALLERGEN-FREE KNIVES**

- ◆ Razor-sharp blade constructed of X50 Cr MoV15 German steel
- ◆ Slip-free grip ergonomic PP handle reduces hand fatigue
- ◆ Protective finger guard
- ◆ Easy edge maintenance and rapid sharpening
- ◆ NSF listed

ITEM	DESCRIPTION	BLADE	UOM	CASE
KWP-30P	Paring Knife, 2-Pcs/Pk	3-1/4" L	Pack	6/36
KWP-80P	Chef's Knife	8" L	Each	6/36
KWP-91P	Bread Knife, Curved	9-1/2" L	Each	6/36
KWP-100P	Chef's Knife	10" L	Each	6/36
KWP-121P	Slicer, Wavy Edge	12" L	Each	6/36



KWP-SERIES **NSF**



PLATING MOLDS



CULINARY PLATING MOLDS

Perfect for baking, freezing, cutting and forming, these ring molds are extremely versatile kitchen tools. Create attractive plate presentations by layering salads and grains, or bake individual cake and pastry portions without waste.

- ◆ Stainless steel
- ◆ Polished smooth to a brilliant mirror finish
- ◆ Dishwasher safe

ITEM	DESCRIPTION	UOM	CASE
SPM-21R	Round, 2"Dia x 1-3/4"H	Each	12/72
SPM-23R	Round, 2"Dia x 3"H	Each	12/72
SPM-31R	Round, 3"Dia x 1-3/4"H	Each	12/72
SPM-31O	Oval, 3"L x 1-3/8"H	Each	12/72
SPM-41O	Oval, 4"L x 1-3/8"H	Each	12/72
SPM-22S	Square, 2"L x 2"W x 2"H	Each	12/72
SPM-275S	Square, 2-3/4"L x 2-3/4"W x 2-3/4"H	Each	12/72
SPM-211T	Rectangular, 2-1/2"L x 1-3/4"W x 1-3/4"H	Each	12/72



SPM-23R

SPM-31R

SPM-21R



SPM-31O

SPM-41O



SPM-211T

SPM-275S

SPM-22S



**SAUCIER SPOON**

Easily create stylish and artistic plated foods with our tapered spout saucier spoons. The tapered end allows for control in drizzling and the deep bowl reduces the need to refill.

- ◆ Ideal for plating dessert, sauces, chocolate and more
- ◆ 18/8 stainless steel with satin finish
- ◆ Features a tapered spout and comfortable handle
- ◆ Dishwasher safe

ITEM	DESCRIPTION	UOM	CASE
SPS-TS8	8" Saucier w/ Tapered Spout	Each	6/72

**PLATING SPOONS**



SPS-TS8



**PLATING SPOONS**

Maintain excellent control in creating stylish presentations with these flat-front plating spoons, available w/ either a solid or perforated spoon bowl.

- ◆ Ideal for plating dessert, sauces, chocolate and more
- ◆ 18/8 stainless steel with satin finish
- ◆ Features a flat front and comfortable handle
- ◆ Dishwasher safe

ITEM	DESCRIPTION	UOM	CASE
SPS-S8	8" Slanted, Solid	Each	6/72
SPS-S10	10" Slanted, Solid	Each	6/72
SPS-P8	8" Slanted, Perforated	Each	6/72
SPS-P10	10" Slanted, Perforated	Each	6/72



SPS-S8



SPS-P8



**PLATING TONGS**

Plating tongs are the discerning chef's ideal tool, providing a controlled, gentle grasp of delicate garnishes for masterful placement and presentation.

- ◆ 18/8 stainless steel
- ◆ Dishwasher safe

ITEM	DESCRIPTION	UOM	CASE
TTG-8C	8" Curved	Each	24/144
TTG-10C	10" Curved	Each	24/144
TTG-8S	8" Straight	Each	24/144
TTG-10S	10" Straight	Each	24/144

**PLATING TONGS**



TTG-8C



TTG-10C



TTG-8S



TTG-10S







## Step up to Winco® Prime – A Cut Above

Winco® Prime products are made with industry approved materials that comply with or exceed accepted industry standards. All products in the Winco Prime family are NSF® listed to give a comfort level that every effort has been made to provide a safe and durable product at an affordable price. Winco Prime products are safe to be used and will hold up well in the most demanding food service environment!

### NSF® BAIN-MARIES

### NSF® INSETS



**NEW** BAMN-6

**NEW** BAMN-6C



**NEW** INSN-7

INSC-7M

#### WINCO PRIME® BAIN-MARIES (NSF)

◆ Stainless steel satin finish

ITEM	DESCRIPTION	SIZE	UOM	CASE
BAMN-1.25	1.25 Qt	5" x 6"	Each	6/48
BAMN-1.5	1.5 Qt	5-1/2" x 5-1/4"	Each	6/48
BAMN-2	2 Qt	5-3/4" x 7"	Each	6/48
BAMN-3.5	3.5 Qt	7-1/4" x 7"	Each	6/36
BAMN-4.25	4.25 Qt	7-1/4" x 7-3/4"	Each	6/36
BAMN-6	6 Qt	8" x 8-3/4"	Each	6/24
BAMN-8.25	8.25 Qt	9" x 9-3/4"	Each	6/24
BAMN-12	12 Qt	10" x 10-1/2"	Each	6/12

#### BAIN-MARIE COVERS (NSF)

◆ Stainless steel satin finish

ITEM	DESCRIPTION	UOM	CASE
BAMN-1.25C	Cover for BAMN-1.25	Each	12/144
BAMN-1.5C	Cover for BAMN-1.5	Each	12/144
BAMN-2C	Cover for BAMN-2	Each	12/144
BAMN-3.5C	Cover for BAMN-3.5	Each	12/144
BAMN-4.25C	Cover for BAMN-4.25	Each	12/72
BAMN-6C	Cover for BAMN-6	Each	12/72
BAMN-8.25C	Cover for BAMN-8.25	Each	12/48
BAMN-12C	Cover for BAMN-12	Each	12/24

#### WINCO PRIME® INSET PANS (NSF)

◆ Stainless steel satin finish

ITEM	DESCRIPTION	SIZE	UOM	CASE
INSN-2.5	2.5 Qt	6" x 7-1/2"	Each	6/36
INSN-4	4 Qt	7-1/2" x 7-1/2"	Each	6/36
INSN-7	7 Qt	9-1/2" x 8"	Each	6/24
INSN-11	11 Qt	11-1/2" x 9"	Each	6/12

#### INSET COVERS (NON-NSF)

◆ Stainless steel mirror finish

ITEM	DESCRIPTION	UOM	CASE
INSC-2.5	Cover for INSN-2.5	Each	6/72
INSC-4	Cover for INSN-4	Each	6/36
INSC-7M	Cover for INSN-7	Each	6/48
INSC-11M	Cover for INSN-11	Each	6/36



Step up to Winco® Prime – A Cut Above

**NSF® LADLES**



**NEW** LDCN-SERIES

**NEW** LDCN-SERIES

**NEW** LDIN-SERIES

**ONE-PIECE COLOR-CODED HANDLE LADLES**

- ◆ Color-coded for portion control
- ◆ Color matched with Winco Prime portioners
- ◆ 1.2mm thick stainless steel

ITEM	DESCRIPTION	COLOR	UOM	CASE
LDCN-1	1 Oz	Black	Each	12/72
LDCN-2	2 Oz	Blue	Each	12/72
LDCN-3	3 Oz	Tan	Each	12/72
LDCN-4	4 Oz	Gray	Each	12/72
LDCN-6	6 Oz	Teal	Each	12/72
LDCN-8	8 Oz	Orange	Each	12/60

**ONE-PIECE BLACK HANDLE LADLES**

- ◆ 1.2mm thick stainless steel

ITEM	DESCRIPTION	UOM	CASE
LDCN-1	1 Oz	Each	12/72
LDCN-2K	2 Oz	Each	12/72
LDCN-3K	3 Oz	Each	12/72
LDCN-4K	4 Oz	Each	12/72
LDCN-6K	6 Oz	Each	12/72
LDCN-8K	8 Oz	Each	12/60

**ONE-PIECE STAINLESS STEEL LADLES**

- ◆ 1.0mm thick stainless steel

ITEM	DESCRIPTION	UOM	CASE
LDIN-0.5	0.5 Oz	Each	12/72
LDIN-0.75	0.75 Oz	Each	12/72
LDIN-1	1 Oz	Each	12/72
LDIN-1.5	1.5 Oz	Each	12/72
LDIN-2	2 Oz	Each	12/72
LDIN-3	3 Oz	Each	12/72
LDIN-4	4 Oz	Each	12/72
LDIN-5	5 Oz	Each	12/72
LDIN-6	6 Oz	Each	12/72
LDIN-8	8 Oz	Each	12/72
LDIN-12	12 Oz	Each	12/72



Step up to Winco® Prime – A Cut Above

**NSF®** PORTIONERS



**NEW** FPSN-SERIES



**NEW** FPPN-SERIES

The Winco® Prime family of products are NSF listed, an assurance that every effort has been made to provide a safe and durable product at an affordable price.

Count on Winco Prime, products made to endure in the most demanding food service environment!

**ONE-PIECE NSF STAINLESS STEEL PORTION CONTROLLERS**  
 ♦ 1.2mm thick stainless steel

ITEM	DESCRIPTION	STYLE	COLOR	UOM	CASE
FPSN-1	1 Oz	Solid	Black	Each	12/72
FPSN-2	2 Oz	Solid	Blue	Each	12/72
FPSN-3	3 Oz	Solid	Tan	Each	12/72
FPSN-4	4 Oz	Solid	Gray	Each	12/72
FPSN-6	6 Oz	Solid	Teal	Each	12/72
FPSN-8	8 Oz	Solid	Orange	Each	12/72
FPPN-1	1 Oz	Perforated	Black	Each	12/72
FPPN-2	2 Oz	Perforated	Blue	Each	12/72
FPPN-3	3 Oz	Perforated	Tan	Each	12/72
FPPN-4	4 Oz	Perforated	Gray	Each	12/72
FPPN-6	6 Oz	Perforated	Teal	Each	12/72
FPPN-8	8 Oz	Perforated	Orange	Each	12/72





Step up to Winco® Prime – A Cut Above

**NSF® BASTING SPOONS**



**NEW** BSON, BSPN, BSSN-SERIES

**NEW** BHON, BHPN, BHSN-SERIES

**ONE-PIECE HEAVY-DUTY BASTING SPOONS**

- ◆ 1.2mm thick stainless steel
- ◆ 18" and 21" spoons are 2.0mm stainless steel

ITEM	DESCRIPTION	HANDLE	UOM	CASE
BSON-11	11" Solid	11"	Each	12/72
BSON-13	13" Solid	13"	Each	12/72
BSON-15	15" Solid	15"	Each	12/72
BSON-18	18" Solid	18"	Each	12/72
BSON-21	21" Solid	21"	Each	12/72
BSPN-11	11" Perf'd	11"	Each	12/72
BSPN-13	13" Perf'd	13"	Each	12/72
BSPN-15	15" Perf'd	15"	Each	12/72
BSPN-18	18" Perf'd	18"	Each	12/72
BSSN-11	11" Slotted	11"	Each	12/72
BSSN-13	13" Slotted	13"	Each	12/72
BSSN-15	15" Slotted	15"	Each	12/72
BSSN-18	18" Slotted	18"	Each	12/72

**BASTING SPOONS WITH STOP-HOOK ABS HANDLE**

- ◆ 1.2mm thick stainless steel

ITEM	DESCRIPTION	HANDLE	UOM	CASE
BHON-11	11" Solid	11"	Each	12/72
BHON-13	13" Solid	13"	Each	12/72
BHON-15	15" Solid	15"	Each	12/72
BHPN-11	11" Perf'd	11"	Each	12/72
BHPN-13	13" Perf'd	13"	Each	12/72
BHPN-15	15" Perf'd	15"	Each	12/72
BHSN-11	11" Slotted	11"	Each	12/72
BHSN-13	13" Slotted	13"	Each	12/72
BHSN-15	15" Slotted	15"	Each	12/72





Step up to Winco Prime® – A Cut Above

**NSF® DISHERS**



**ONE-PIECE DELUXE DISHERS**

- ◆ Great for mashed potatoes, cookie dough and more
- ◆ One-piece handle construction reinforced with S/S rod
- ◆ Sturdy, durable 18/8 stainless steel
- ◆ Includes right hand indicator
- ◆ NSF listed

ITEM	DESCRIPTION	SIZE	COLOR	UOM	CASE
ICOP-6	5-1/3 Oz, 3-3/16"Dia	6	White	Each	1/36
ICOP-8	4 Oz, 2-7/8"Dia	8	Gray	Each	1/36
ICOP-10	3-1/4 Oz, 2-11/16"Dia	10	Ivory	Each	1/36
ICOP-12	2-2/3 Oz, 2-7/16"Dia	12	Green	Each	1/36
ICOP-16	2 Oz, 2-1/4"Dia	16	Blue	Each	1/36
ICOP-20	1-5/8 Oz, 2-1/8"Dia	20	Yellow	Each	1/36
ICOP-24	1-1/3 Oz, 2"Dia	24	Red	Each	1/36
ICOP-30	1 Oz, 1-13/16"Dia	30	Black	Each	1/36
ICOP-40	3/4 Oz, 1-5/8"Dia	40	Purple	Each	1/36



**DISHERS**

- ◆ 18/8 stainless steel
- ◆ NSF listed

ITEM	DESCRIPTION	SIZE	COLOR	UOM	CASE
ICD-6	4-2/3 Oz, 3"Dia	6	White	Each	1/36
ICD-8	4 Oz, 2-3/4"Dia	8	Gray	Each	1/36
ICD-10	3-3/4 Oz, 2-5/8"Dia	10	Ivory	Each	1/36
ICD-12	3-1/4 Oz, 2-1/2"Dia	12	Green	Each	1/36
ICD-16	2-3/4 Oz, 2-1/4"Dia	16	Blue	Each	1/36
ICD-20	2 Oz, 2-1/8"Dia	20	Yellow	Each	1/36
ICD-24	1-3/4 Oz, 2"Dia	24	Red	Each	1/36
ICD-30	1-1/4 Oz, 1-7/8"Dia	30	Black	Each	1/36
ICD-40	7/8 Oz, 1-5/8"Dia	40	Purple	Each	1/36

**NSF® ICD-SERIES**



ISS-SERIES



AICD-12



ICS-1

**SQUEEZE DISHERS/PORTIONERS**

- ◆ 18/8 stainless steel

ITEM	DESCRIPTION	SIZE	UOM	CASE
ISS-8	4 Oz, 2-3/4"Dia	8	Each	12/48
ISS-10	3-3/4 Oz, 2-5/8"Dia	10	Each	12/48
ISS-12	3-1/4 Oz, 2-1/2"Dia	12	Each	12/48
ISS-16	2-3/4 Oz, 2-1/4"Dia	16	Each	12/48
ISS-20	2-1/2 Oz, 2-1/8"Dia	20	Each	12/48
ISS-24	1-3/4 Oz, 1-15/16"Dia	24	Each	12/48
ISS-30	1-1/4 Oz, 1-7/8"Dia	30	Each	12/48
ISS-40	7/8 Oz, 1-3/4"Dia	40	Each	12/48
ISS-50	5/8 Oz, 1-1/2"Dia	50	Each	12/48
ISS-60	9/16 Oz, 1-7/16"Dia	60	Each	12/48
ISS-70	1/2 Oz, 1-3/8"Dia	70	Each	12/48
ISS-100	3/8 Oz, 1-1/8"Dia	100	Each	12/48

**ICE CREAM DIPPERS, SELF-DEFROSTING**

- ◆ Cast aluminum, hand wash only
- ◆ Contains non-toxic heat conductive fluid that enables dipper to self-defrost

ITEM	DESCRIPTION	SIZE	UOM	CASE
AICD-12	3 Oz	12	Each	12/144
AICD-16	2-1/2 Oz	16	Each	12/144
AICD-20	2 Oz	20	Each	12/144
AICD-24	1-1/2 Oz	24	Each	12/144

**ICE CREAM SPADE**

ITEM	DESCRIPTION	UOM	CASE
ICS-1	Ice Cream Spade	Each	12/120



### STAINLESS STEEL HOOKED HANDLE DIPPER

◆ Graduation marks visible on inside and outside

ITEM	DESCRIPTION	HANDLE	UOM	CASE
SHHD-1	1 Qt	12"	Each	12/48

### ALUMINUM TRANSFER DIPPER

◆ Heavyweight and dent-resistant with 6-1/2" welded handle

ITEM	DESCRIPTION	HANDLE	UOM	CASE
ALD-30	30 Oz	6-1/2"	Each	12/48

### ONE-PIECE STAINLESS STEEL LADLES

ITEM	DESCRIPTION	HANDLE	UOM	CASE
LDI-0	0.5 Oz	10-1/4"	Each	12/240
LDI-1	1 Oz	10-3/8"	Each	12/240
LDI-1.5	1.5 Oz	10-1/8"	Each	12/120
LDI-2	2 Oz	10-1/2"	Each	12/240
LDI-3	3 Oz	11-1/8"	Each	12/120
LDI-4	4 Oz	12-1/4"	Each	12/120
LDI-5	5 Oz	12-1/2"	Each	12/120
LDI-6	6 Oz	12-1/2"	Each	12/120
LDI-8	8 Oz	12-1/2"	Each	12/120
LDI-12	12 Oz	12-3/4"	Each	12/120
LDI-16	16 Oz	11-1/2"	Each	12/120

### TWO-PIECE STAINLESS STEEL LADLES

ITEM	DESCRIPTION	HANDLE	UOM	CASE
LDT-1	1 Oz	12"	Each	12/120
LDT-4	4 Oz	14"	Each	12/120
LDT-6	6 Oz	14"	Each	12/120
LDT-32	32 Oz	16"	Each	12/60

### STAINLESS STEEL SHORT HANDLE LADLES

ITEM	DESCRIPTION	HANDLE	UOM	CASE
LDI-05SH	0.5 Oz, One-Pc	6"	Each	12/120
LDI-10SH	1 Oz, One-Pc	6"	Each	12/120
LDI-15SH	1.5 Oz, One-Pc	6"	Each	12/120
LDI-20SH	2 Oz, One-Pc	6"	Each	12/120
LDI-30SH	3 Oz, One-Pc	6"	Each	12/120
LDI-40SH	4 Oz, One-Pc	6"	Each	12/120
LDI-60SH	6 Oz, One-Pc	6"	Each	12/120
LDS-0	0.5 Oz, Two-Pc	8"	Each	12/120
LDS-1	1 Oz, Two-Pc	8"	Each	12/120
LDS-2	2 Oz, Two-Pc	8"	Each	12/120
LDS-3	3 Oz, Two-Pc	8"	Each	12/120
LDS-4	4 Oz, Two-Pc	8"	Each	12/120
LDS-6	6 Oz, Two-Pc	8"	Each	12/120

### ONE-PIECE STAINLESS STEEL COLOR-CODED LADLES

ITEM	DESCRIPTION	HANDLE	UOM	CASE
LDC-05	0.5 Oz, Teal	12"	Each	12/120
LDC-1	1 Oz, Yellow	12"	Each	12/120
LDC-2	2 Oz, Red	12-1/2"	Each	12/120
LDC-3	3 Oz, Ivory	13"	Each	12/120
LDC-4	4 Oz, Green	15-1/2"	Each	12/120
LDC-6	6 Oz, Black	15-1/2"	Each	12/120
LDC-8	8 Oz, Blue	16-1/2"	Each	12/60
LDC-12	12 Oz, Gray	16-1/2"	Each	12/60



### ONE-PIECE STAINLESS STEEL PORTION CONTROLLERS

ITEM	DESCRIPTION	STYLE	COLOR	UOM	CASE
FPS-1	1 Oz	Solid	Yellow	Each	12/72
FPS-2	2 Oz	Solid	Red	Each	12/72
FPS-3	3 Oz	Solid	Ivory	Each	12/72
FPS-4	4 Oz	Solid	Green	Each	12/72
FPS-6	6 Oz	Solid	Black	Each	12/72
FPS-8	8 Oz	Solid	Blue	Each	12/72
FPP-1	1 Oz	Perforated	Yellow	Each	12/72
FPP-2	2 Oz	Perforated	Red	Each	12/72
FPP-3	3 Oz	Perforated	Ivory	Each	12/72
FPP-4	4 Oz	Perforated	Green	Each	12/72
FPP-6	6 Oz	Perforated	Black	Each	12/72
FPP-8	8 Oz	Perforated	Blue	Each	12/72

## LADLES & PORTION CONTROLLERS



SEE PAGE 257 FOR NSF LISTED UTENSILS

HIGHLY POLISHED MIRROR FINISH



NEW SIZES



UTILITY TONGS



UTPH-SERIES



UT-SERIES

Tongs for cold food service only



UT-9HT



UT-9



UT-9LT

HEAT RESISTANT HEAVY-DUTY UTILITY TONGS

- ◆ Texturized non-slip PP handle for comfort and ease of use, heat resistant up to 220°F (104°C)
- ◆ Color-coded to help prevent cross-contamination in kitchen or buffet areas
- ◆ Made in Korea
- ◆ Stainless steel

ITEM	DESCRIPTION	COLOR	UOM	CASE
UTPH-9B	9"	Blue	Each	6/72
UTPH-9G	9"	Green	Each	6/72
UTPH-9K	9"	Black	Each	6/72
UTPH-9R	9"	Red	Each	6/72
UTPH-9Y	9"	Yellow	Each	6/72
UTPH-12B	12"	Blue	Each	6/72
UTPH-12G	12"	Green	Each	6/72
UTPH-12K	12"	Black	Each	6/72
UTPH-12R	12"	Red	Each	6/72
UTPH-12Y	12"	Yellow	Each	6/72
UTPH-16B	16"	Blue	Each	6/72
UTPH-16G	16"	Green	Each	6/72
UTPH-16K	16"	Black	Each	6/72
UTPH-16R	16"	Red	Each	6/72
UTPH-16Y	16"	Yellow	Each	6/72

HEAVY-DUTY UTILITY TONGS WITH PLASTIC HANDLE

- ◆ For cold food service only
- ◆ Color-coded to help prevent cross-contact in kitchen or buffet areas
- ◆ Stainless steel

ITEM	DESCRIPTION	COLOR	UOM	CASE
UT-9HP-B	9"	Blue	Each	12/72
UT-9HP-G	9"	Green	Each	12/72
UT-9HP-K	9"	Black	Each	12/72
UT-9HP-R	9"	Red	Each	12/72
UT-9HP-Y	9"	Yellow	Each	12/72
UT-12HP-B	12"	Blue	Each	12/72
UT-12HP-G	12"	Green	Each	12/72
UT-12HP-K	12"	Black	Each	12/72
UT-12HP-R	12"	Red	Each	12/72
UT-12HP-Y	12"	Yellow	Each	12/72
UT-16HP-B	16"	Blue	Each	12/72
UT-16HP-G	16"	Green	Each	12/72
UT-16HP-K	16"	Black	Each	12/72
UT-16HP-R	16"	Red	Each	12/72
UT-16HP-Y	16"	Yellow	Each	12/72

EXTRA HEAVYWEIGHT UTILITY TONGS

- ◆ Coiled spring
- ◆ 1.2mm thick stainless steel

ITEM	DESCRIPTION	UOM	CASE
UT-9HT	9"	Each	12/72
UT-12HT	12"	Each	12/72
UT-16HT	16"	Each	12/72

HEAVYWEIGHT UTILITY TONGS

- ◆ Coiled spring
- ◆ 0.9mm thick stainless steel

ITEM	DESCRIPTION	UOM	CASE
UT-7	7" (Specially designed for table service)	Each	12/72
UT-9	9"	Each	12/72
UT-12	12"	Each	12/72
UT-16	16"	Each	12/72

MEDIUM-WEIGHT UTILITY TONGS

- ◆ Coiled spring
- ◆ 0.6mm thick stainless steel

ITEM	DESCRIPTION	UOM	CASE
UT-9LT	9"	Each	12/72
UT-12LT	12"	Each	12/72
UT-16LT	16"	Each	12/72

### HEAVY-DUTY BASTING SPOONS

◆ 2.0mm thick stainless steel

ITEM	DESCRIPTION	UOM	CASE
BHKS-21	21" Solid	Each	6/48
BHKP-21	21" Perforated	Each	6/48

### ONE-PIECE HEAVY-DUTY BASTING SPOONS

◆ 1.5mm thick stainless steel

ITEM	DESCRIPTION	UOM	CASE
BSOT-11H	11" Solid	Each	12/144
BSOT-13H	13" Solid	Each	12/144
BSOT-15H	15" Solid	Each	12/144
BSOT-18	18" Solid	Each	12/72
BSOT-21	21" Solid	Each	12/72
BSPT-11H	11" Perforated	Each	12/144
BSPT-13H	13" Perforated	Each	12/144
BSPT-15H	15" Perforated	Each	12/144
BSPT-18	18" Perforated	Each	12/72
BSST-11H	11" Slotted	Each	12/144
BSST-13H	13" Slotted	Each	12/144
BSST-15H	15" Slotted	Each	12/144
BSST-18	18" Slotted	Each	12/72

### BASTING SPOONS

◆ 1.2mm thick stainless steel

ITEM	DESCRIPTION	UOM	CASE
BSOT-11	11" Solid	Each	12/144
BSOT-13	13" Solid	Each	12/144
BSOT-15	15" Solid	Each	12/144
BSPT-11	11" Perforated	Each	12/144
BSPT-13	13" Perforated	Each	12/144
BSPT-15	15" Perforated	Each	12/144
BSST-11	11" Slotted	Each	12/144
BSST-13	13" Slotted	Each	12/144
BSST-15	15" Slotted	Each	12/144

### BASTING FORKS

◆ 1.5mm thick stainless steel

ITEM	DESCRIPTION	UOM	CASE
BSFK-18	18"	Each	12/72
BSFK-21	21"	Each	12/72
BHKF-21	21", 2.0mm thick	Each	6/48

### BASTING SPOONS WITH PP HANDLE

◆ 1.2mm thick stainless steel

ITEM	DESCRIPTION	UOM	CASE
BSOB-11	11" Solid	Each	12/72
BSOB-13	13" Solid	Each	12/72
BSOB-15	15" Solid	Each	12/72
BSPB-11	11" Perforated	Each	12/72
BSPB-13	13" Perforated	Each	12/72
BSPB-15	15" Perforated	Each	12/72
BSSB-11	11" Slotted	Each	12/72
BSSB-13	13" Slotted	Each	12/72
BSSB-15	15" Slotted	Each	12/72

### BASTING SPOONS WITH STOP-HOOK PP HANDLE

◆ 1.2mm thick stainless steel

ITEM	DESCRIPTION	UOM	CASE
BHOP-11	11" Solid	Each	12/120
BHOP-13	13" Solid	Each	12/120
BHOP-15	15" Solid	Each	12/120
BHPP-11	11" Perforated	Each	12/120
BHPP-13	13" Perforated	Each	12/120
BHPP-15	15" Perforated	Each	12/120
BHSP-11	11" Slotted	Each	12/120
BHSP-13	13" Slotted	Each	12/120
BHSP-15	15" Slotted	Each	12/120

## BASTING UTENSILS



SEE PAGE 259 FOR NSF LISTED UTENSILS



**POLYCARBONATE  
SERVING UTENSILS**



**NSF** PUT-SERIES



PUTF-6K



**NSF** PPT-SERIES



PSSB-SERIES



PSS-SERIES



PLD-SERIES

**UTILITY TONGS**

ITEM	DESCRIPTION	SIZE	UOM	CASE
PUT-6B	Beige	6"	Each	12/192
PUT-6C	Clear	6"	Each	12/192
PUT-6K	Black	6"	Each	12/192
PUT-6R	Red	6"	Each	12/192
PUT-9B	Beige	9"	Each	12/144
PUT-9C	Clear	9"	Each	12/144
PUT-9K	Black	9"	Each	12/144
PUT-9R	Red	9"	Each	12/144
PUT-9W	White	9"	Each	12/144
PUT-12B	Beige	12"	Each	12/144
PUT-12C	Clear	12"	Each	12/144
PUT-12K	Black	12"	Each	12/144
PUT-12R	Red	12"	Each	12/144

**FLAT TONGS**

ITEM	DESCRIPTION	SIZE	UOM	CASE
PUTF-6B	Beige	6"	Each	12/432
<b>NSF</b> PUTF-6C	Clear, NSF	6"	Each	12/432
PUTF-6K	Black	6"	Each	12/432

**SPAGHETTI TONGS**

◆ Heat-resistant up to 302°F (150°C)

ITEM	DESCRIPTION	SIZE	UOM	CASE
PPT-11B	Beige	11"	Each	24/144
PPT-11C	Clear	11"	Each	24/144
PPT-11K	Black	11"	Each	24/144

**BUFFET SPOONS**

◆ 3/4 oz capacity

ITEM	DESCRIPTION	SIZE	UOM	CASE
PSSB-10B	Beige	10"	Each	12/384
<b>NSF</b> PSSB-10C	Clear, NSF	10"	Each	12/384
PSSB-10K	Black	10"	Each	12/384
PSSB-10R	Red	10"	Each	12/384

**SERVING SPOONS**

ITEM	DESCRIPTION	SIZE	UOM	CASE
PSS-13C	Clear	13"	Doz	12
PSS-13K	Black	13"	Doz	12
PSS-13R	Red	13"	Doz	12
PSS-15K	Black	15"	Doz	12

**ONE-PIECE LADLES**

ITEM	DESCRIPTION	CAPACITY	SIZE	UOM	CASE
PLD-8B	Beige	3/4 Oz	8-1/2"	Each	12/192
PLD-8C	Clear	3/4 Oz	8-1/2"	Each	12/192
PLD-8K	Black	3/4 Oz	8-1/2"	Each	12/192
PLD-8R	Red	3/4 Oz	8-1/2"	Each	12/192
PLD-13B	Beige	1 Oz	13"	Each	12/192
PLD-13C	Clear	1 Oz	13"	Each	12/192
PLD-13K	Black	1 Oz	13"	Each	12/192
PLD-13R	Red	1 Oz	13"	Each	12/192

With a locking clip and non-slip silicone grip and tips, these utility tongs are made to use on non-stick coated pans to prevent scratching.

## LOCKING TONGS

### SILICONE GRIP UTILITY TONGS

- ◆ 0.6mm thick stainless steel
- ◆ Heat-resistant up to 400 °F (210°C)

ITEM	DESCRIPTION	UOM	CASE
UTS-9K	9"	Each	12/72
UTS-12K	12"	Each	12/72



### UTILITY TONG

- ◆ 0.5mm thick stainless steel
- ◆ Locking ring and non-slip grip
- ◆ Heat-resistant up to 400 °F (210°C)

ITEM	DESCRIPTION	UOM	CASE
UT-7K	7"	Each	24/144



### HEAVYWEIGHT UTILITY TONGS WITH LOCKING RING

- ◆ Coil spring
- ◆ 0.9mm thick stainless steel

ITEM	DESCRIPTION	UOM	CASE
UTLK-7	7"	Each	12/72
UTLK-9	9"	Each	12/72
UTLK-12	12"	Each	12/72
UTLK-16	16"	Each	12/72



### SERVING TONGS

These heavyweight 18/8 satin finished stainless steel serving tongs are designed for comfortable service in elegant settings.

- ◆ Great for buffets, catered events and more
- ◆ Dishwasher safe

ITEM	DESCRIPTION	SIZE	UOM	CASE
STH-8	Short	8.5"	Each	12/72
STH-10	Medium	10.5"	Each	12/72
STH-13	Long	13.5"	Each	12/72

### STAINLESS STEEL SERVING TONGS



### SALAD TONGS

ITEM	DESCRIPTION	SIZE	UOM	CASE
PTOS-8	Oval, Satin Finish	7-3/4"	Each	12/96
ST-2	Double Spoon, Mirror Finish	10"	Each	6/60
ST-10	Fork and Spoon, Satin Finish	10"	Each	6/60
ST-10S	Slotted and Solid Spatula, Mirror Finish	10"	Each	12/96
ST-105SF	Spatula and Fork, Mirror Finish	10-1/2"	Each	12/96

### PASTRY TONGS

ITEM	DESCRIPTION	SIZE	UOM	CASE
PT-8	Solid with Short Handle	7-1/2"	Each	12/120
PT-875	Solid with Long Handle	8-3/4"	Each	12/144
PT-10P	Perforated	10-1/2"	Each	12/96

### SPAGHETTI TONGS

ITEM	DESCRIPTION	SIZE	UOM	CASE
ST-8	Mirror Finish	8"	Each	12/240

### ICE TONGS

ITEM	DESCRIPTION	SIZE	UOM	CASE
ICT-7	Five Prong, Textured	7"	Each	12/144
IT-7	Three Prong, Satin Finish	7"	Each	12/120

### POM TONGS

ITEM	DESCRIPTION	SIZE	UOM	CASE
PT-6	Satin Finish	6"	Doz	4/24
PT-9	Satin Finish	9"	Doz	4/24

## STAINLESS STEEL WHIPS

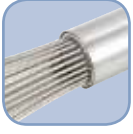

NSF<sup>®</sup> FN-SERIES



NSF<sup>®</sup> PN-SERIES



MWP-40

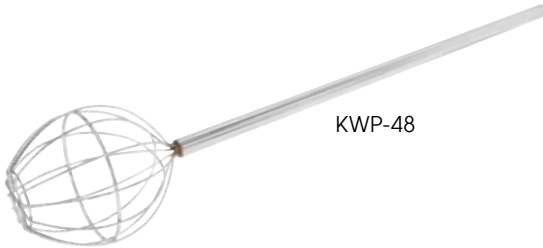

KWP-48



### FRENCH WHIPS

◆ Stainless steel, NSF listed

ITEM	DESCRIPTION	UOM	CASE
FN-10	10"	Each	12/72
FN-12	12"	Each	12/72
FN-14	14"	Each	12/72
FN-16	16"	Each	12/60
FN-18	18"	Each	12/60
FN-20	20"	Each	12/60
FN-22	22"	Each	12/60
FN-24	24"	Each	12/60



### PIANO WHIPS

◆ Stainless steel, NSF listed

ITEM	DESCRIPTION	UOM	CASE
PN-10	10"	Each	12/72
PN-12	12"	Each	12/72
PN-14	14"	Each	12/72
PN-16	16"	Each	12/72
PN-18	18"	Each	12/72

### KETTLE & MAYONNAISE WHIPS

ITEM	DESCRIPTION	UOM	CASE
MWP-40	Mayonnaise Whip, 40"	Each	8
KWP-48	Kettle Whip, 48"	Each	8

## MASHERS



PTMP-24S



PTMP-18R



PTM-24R



PTM-18S



PR-9



PR-16

## POTATO MASHERS

*Our professional-quality mashers are nickel-plated, heavy-duty enough to be used for all root vegetables. The handles are chrome-plated for durability with a choice of polypropylene or wooden handles.*

### STEEL POTATO MASHERS W/PLASTIC SLEEVE GRIP

ITEM	DESCRIPTION	SIZE	UOM	CASE
PTMP-18R	Round	4" x 18"	Each	6/12
PTMP-18S	Square	4-1/2" x 17-3/4"	Each	6/12
PTMP-24R	Round	5" x 24-1/2"	Each	6/12
PTMP-24S	Square	5-1/4" x 24"	Each	6/12

### WOODEN HANDLE POTATO MASHERS

ITEM	DESCRIPTION	SIZE	UOM	CASE
PTM-18R	4" Round	18" Handle	Each	6/12
PTM-18S	4-1/2" Square	17-3/4" Handle	Each	6/12
PTM-24R	5" Round	24-1/2" Handle	Each	6/12
PTM-24S	5-1/4" Square	24" Handle	Each	6/12

### POTATO RICERS

◆ Stainless steel

ITEM	DESCRIPTION	UOM	CASE
PR-9	Economy, Round	Each	6
PR-16	Square	Each	1/6

**BLACK NYLON COOKING TOOLS**

These durable nylon cooking tools are available in a variety of options to cover all sorts of uses. Handy to have around the kitchen, they withstand high temps and won't scuff or scratch.

- ◆ Non-stick friendly
- ◆ Heat resistant up to 410°F (210°C)
- ◆ BPA-free

ITEM	DESCRIPTION	UOM	CASE
NC-WS	A. Slotted Spatula	Each	12/144
NC-SL2	B. Slotted Spoon	Each	12/144
NC-SS1	C. Solid Spoon	Each	12/144
NC-PF2	D. 2-Prong Fork	Each	12/144
NC-PS1	E. Pasta Fork	Each	12/144
NC-RS	F. Fish Spatula	Each	12/144
NC-LD	G. Ladle	Each	12/144
NC-MS	H. Masher	Each	12/144
NC-SK	I. Skimmer	Each	12/144
NC-WP	J. Whisk	Each	12/144



**NYLON COOKING TOOLS**



NC-SERIES **BPA FREE**

**SILICONE BRUSH**

The perfect tool for brushing on marinades, oil or butter onto meats, fish or breads! This silicone brush won't scratch foods and is non-stick friendly.

- ◆ Non-stick friendly and easy to clean
- ◆ 100% silicone exterior; stainless steel interior
- ◆ Heat resistant up to 428°F (220°C)
- ◆ Dishwasher safe for easier cleanup
- ◆ BPA-free

ITEM	DESCRIPTION	UOM	CASE
SB-175R	1-3/4"W	Each	24/144



**SILICONE BRUSH**



SB-175R **BPA FREE**



MIXING PADDLES & SPOONS



MPD-24

MPD-36

WSP-24



NSP-10W

**BPA FREE** NSP-SERIES



NS-15B

NS-15R

NS-15T

NS-15W

**BPA FREE** NS-SERIES



WWP-SERIES

STAINLESS STEEL MIXING PADDLES

ITEM	DESCRIPTION	UOM	CASE
MPD-24	24"	Each	12
MPD-36	36"	Each	12
MPD-48	48"	Each	12
MPD-60	60"	Each	12

WOODEN STIRRING PADDLES

ITEM	DESCRIPTION	UOM	CASE
WSP-18	18"	Each	4/36
WSP-24	24"	Each	4/36
WSP-36	36"	Each	4/36
WSP-48	48"	Each	4/36

 NYLON MIXING PADDLES

Mix, fold or spread anything from icing to batters with this nylon mixing paddle. The stain-resistant, sturdy one-piece construction is resistant to high temperatures, making it ideal for melting chocolate on hot stove tops.

- ◆ High temperature nylon is heat-resistant up to 425°F (220°C)
- ◆ BPA-free

ITEM	DESCRIPTION	UOM	CASE
NSP-10W	10"	Each	12/120
NSP-14W	14"	Each	12/120
NSP-20W	20"	Each	12/120

 HIGH HEAT NYLON SPOONS

- ◆ Easy to clean one-piece construction
- ◆ Ideal for non-stick cookware; Stain resistant
- ◆ Heat resistant up to 400°F (204°C)
- ◆ BPA-free

ITEM	DESCRIPTION	UOM	CASE
NS-12B	12", Blue	Each	24/144
NS-12R	12", Red	Each	24/144
NS-12T	12", Tan	Each	24/144
NS-12W	12", Off-white	Each	24/144
NS-15B	15", Blue	Each	24/72
NS-15R	15", Red	Each	24/72
NS-15T	15", Tan	Each	24/72
NS-15W	15", Off-white	Each	24/72

 WOODEN SPOONS

ITEM	DESCRIPTION	UOM	CASE
WWP-12	12"	Doz	1/8
WWP-14	14"	Doz	1/8
WWP-16	16"	Doz	1/8
WWP-18	18"	Doz	1/8

**ALLERGEN-FREE COLOR CODED SCRAPER**

Solve the challenges of maintaining an allergen-aware kitchen! Improve customer dining experiences while raising the bar for food safety. Prevent cross-contaminating allergens with the extensive line of Allergen-Free tools by Winco®. Whether it's gluten, nuts or more, use this stand-out purple color to designate these scrapers as allergen-free.

- ◆ Features raised ridges for resting to prevent messy counters
- ◆ Nylon handles heat-resistant up to 600°F (315°C)

ITEM	DESCRIPTION	UOM	CASE
PSH-10P	10-1/2"	Each	24/144
PSH-14P	14"	Each	24/144
PSH-16P	16-1/4"	Each	24/144

**SILICONE SCRAPERS**

- ◆ Features raised ridges for resting to prevent messy counters
- ◆ Nylon handles heat-resistant up to 600°F (315°C)

ITEM	DESCRIPTION	UOM	CASE
PSH-10	10-1/2"	Each	24/144
PSH-14	14"	Each	24/144
PSH-16	16-1/4"	Each	24/144

**BOWL-SHAPED SILICONE SCRAPERS**

- ◆ Heat-resistant up to 500°F (260°C)

ITEM	DESCRIPTION	UOM	CASE
PSG-10	10"	Each	12/120
PSG-14	14"	Each	12/120
PSG-16	16"	Each	12/120

**ECONOMY SILICONE SCRAPERS**

- ◆ Heat-resistant up to 500°F (260°C)

ITEM	DESCRIPTION	UOM	CASE
PSD-10	10"	Each	12/120
PSD-14	14"	Each	12/120
PSD-16	16"	Each	12/120

**BOWL-SHAPED PLASTIC SCRAPERS**

- ◆ BPA-free

ITEM	DESCRIPTION	UOM	CASE
PSGE-10	10"	Each	12/120
PSGE-14	14"	Each	12/72
PSGE-16	16"	Each	12/36

**PLASTIC SCRAPERS**

- ◆ BPA-free

ITEM	DESCRIPTION	UOM	CASE
PSC-10	10"	Each	24/360
PSC-14	14"	Each	12/288
PSC-16	16"	Each	12/288

**SCRAPERS**

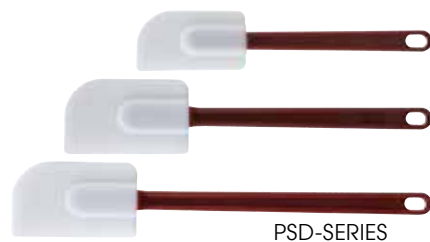
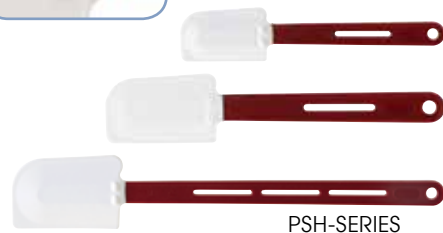

## MINI MEASURING LADLES



MSL-5S



MSL-11



## MINI MEASURING LADLES

Easily portion and serve smaller quantities with mini ladles in varying capacities.

- ◆ Ideal for either measuring or serving small quantities
- ◆ Durable 18/8 stainless steel construction
- ◆ Capacity stamped on each handle

ITEM	DESCRIPTION	UOM	CASE
MSL-5S	5-Pc Set: 1/8 Tsp, 1/4 Tsp, 1/2 Tsp, 1 Tsp, 1 Tbsp	Set	12/72
MSL-11	3/4 Tbsp	Each	60/300



## MEASURING SPOONS



MSP-4P



MSPD-4X



MSPP-4

BPA FREE

## STAINLESS STEEL MEASURING SPOON SETS

- ◆ Set includes: 1/4 Tsp, 1/2 Tsp, 1 Tsp, 1 Tbsp

ITEM	DESCRIPTION	UOM	CASE
MSP-4P	4-Pc Set	Set	12/288
MSPD-4X	Deluxe 4-Pc Set	Set	24/240



## PLASTIC MEASURING SPOON SET

- ◆ Set includes: 1/4 Tsp, 1/2 Tsp, 1 Tsp, 1 Tbsp
- ◆ BPA-free

ITEM	DESCRIPTION	UOM	CASE
MSPP-4	4-Pc Set	Set	12/216

## PLASTIC MEASURING CUPS



MCPP-4

BPA FREE



## PLASTIC MEASURING CUP SET

- ◆ Set includes: 1/4 Cup, 1/3 Cup, 1/2 Cup, 1 Cup
- ◆ BPA-free

ITEM	DESCRIPTION	UOM	CASE
MCPP-4	4-Pc Set	Set	12/72

**STAINLESS STEEL MEASURING CUP SET**

◆ Set includes: 1/4 Cup, 1/3 Cup, 1/2 Cup, 1 Cup

ITEM	DESCRIPTION	UOM	CASE
MCP-4P	4-Pc Set	Set	12/48

**STAINLESS STEEL MEASURING CUPS**



MCP-4P

**ALUMINUM MEASURES**

ITEM	DESCRIPTION	UOM	CASE
AM-05	1/2 Qt	Each	1/48
AM-1	1 Qt	Each	1/36
AM-2	2 Qt	Each	1/36
AM-4	4 Qt	Each	1/24

**ALUMINUM MEASURES**



AM-2

**DELUXE MEASURING CUPS**

- ◆ Molded one-piece break-resistant polycarbonate
- ◆ Raised external markings in both quarts (red letters) and liters (blue letters)
- ◆ Tapered open handle for a secure grip; stackable
- ◆ Dishwasher safe

ITEM	DESCRIPTION	UOM	CASE
PMCP-25	1 Cup	Each	6/72
PMCP-50	1 Pint	Each	6/72
PMCP-100	1 Qt	Each	6/36
PMCP-200	2 Qt	Each	6/36
PMCP-400	4 Qt	Each	6/24
PMCP-5SET	Complete 5-Pc Set	Set	1/6



**POLYCARBONATE MEASURING CUPS**



PMCP-SERIES **NSF**

**MEASURING CUPS**

- ◆ Durable polycarbonate w/raised graduation markings
- ◆ NSF listed

ITEM	DESCRIPTION	UOM	CASE
PMU-25	1 Cup	Each	36
PMU-50	1 Pint	Each	36
PMU-100	1 Qt	Each	36
PMU-200	2 Qt	Each	36
PMU-400	4 Qt	Each	12



PMU-SERIES **NSF**





# SPATULAS & TURNERS

- ◆ Stainless steel, satin finish blade
- ◆ Ergonomic handle with slip-free comfort grip reduces hand fatigue
- ◆ Dishwasher safe
- ◆ NSF listed (TNH-Series)

**HIGH-QUALITY  
LOW COST**



DESCRIPTION	BLADE SIZE (LxW)	UOM	HIGH-HEAT ORANGE NYLON ERGO HANDLE		WOODEN HANDLE	
			ITEM	CASE	ITEM	CASE
Mini Turner	2" x 2-1/4"	* Each			TN32	12/120
Sandwich Spreader	3-5/8" x 1-1/4"	Each			TN713	12/144
Small Scraper	4-1/2" x 3-1/8"	Each			TN526	12/72
Large Scraper	4-7/8" x 4"	Each			TN54	12/72
Steak/Burger Turner	4-1/8" x 3-3/4"	* Each			TN46	12/72
Turner	8" x 4"	Each	TNH-42	12/48	TN48	12/24
Grill Spatula	4-1/4" x 2-3/16"	* Each			TN165	12/72
Teppanyaki Turner, Full Tang	4" x 3-1/2"	* Each			TN43	12/72
Pie Server	4-5/8" x 2-3/8"	* Each			TN166	12/72
Fish Spatula	6-3/4" x 3-1/4"	Each	TNH-60	12/144	FST-6	12/144
Hamburger Turner	5-1/8" x 2-7/8"	* Each	TNH-61	12/72	TN719	12/72
Extra Heavy Turner, Cutting Edge Blade	5" x 6"	* Each	TNH-63	12/48	TN56	12/48
Square Edge Turner	6-1/4" x 3"	* Each	TNH-64	12/72		
Square Edge Turner	7-1/4" x 3"	* Each	TNH-70	12/48		
Flexible Turner	8-1/4" x 2-7/8"	* Each	TNH-90	12/48	TN249	12/48
Flexible Turner (Perforated Blade)	8-1/4" x 2-7/8"	* Each	TNH-91	12/48	TN409	12/48
Offset Giant Turner	8-1/2" x 2-7/8"	* Each			TN44	12/48
Offset Spatula	3-1/2" x 3/4"	* Each			TOS-4	24/288
Offset Spatula	6-1/2" x 1-5/16"	* Each			TOS-7	12/144
Offset Spatula	8-1/2" x 1-1/2"	* Each			TOS-9	12/72
Bakery Spatula	4" x 3/4"	Each			TNS-4	24/288
Bakery Spatula	7-15/16" x 1-1/4"	Each			TNS-7	12/144
Bakery Spatula	10" x 1-3/8"	Each			TNS-9	12/72

\*Measurement reflects blade size not including offset

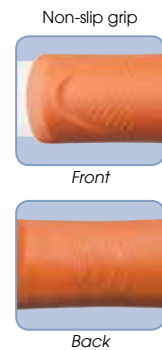
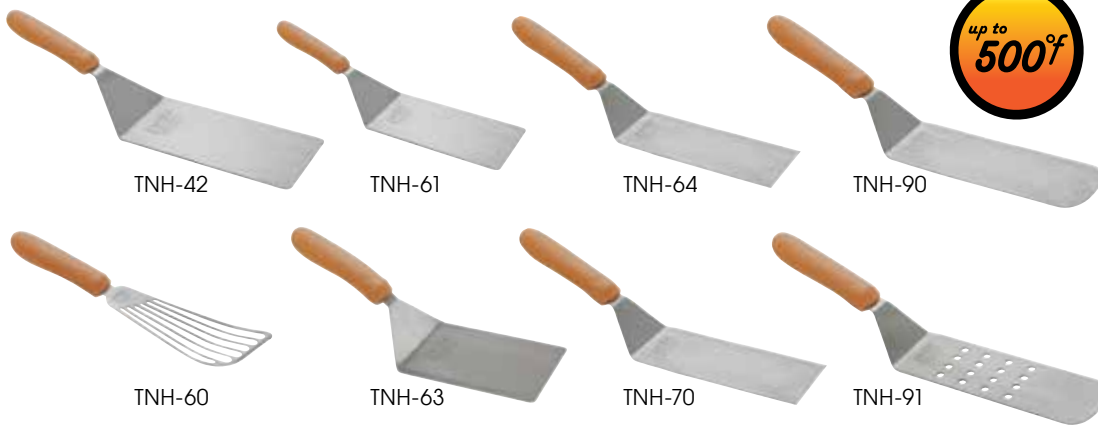

**NSF** TNH-SERIES (ORANGE)



Relative size comparisons shown

# SPATULAS & TURNERS

- ◆ Stainless steel, satin finish blade
- ◆ Ergonomic handle with slip-free comfort grip reduces hand fatigue
- ◆ Dishwasher safe
- ◆ NSF listed



DESCRIPTION	BLADE SIZE (L X W)	UOM	BLACK ERGO HANDLE		WHITE ERGO HANDLE	
			ITEM	CASE	ITEM	CASE
Mini Turner	2" x 2-1/4"	* Each	TKP-30	12/120	TWP-30	12/120
Sandwich Spreader	3-5/8" x 1-1/4"	Each	TKP-31	12/144	TWP-31	12/144
Small Scraper	4-1/2" x 3-1/8"	Each	TKP-32	12/72	TWP-32	12/72
Large Scraper	4-7/8" x 4"	Each	TKP-40	12/72	TWP-40	12/120
Steak/Burger Turner	4-1/8" x 3-3/4"	* Each	TKP-41	12/72	TWP-41	12/72
Turner	8" x 4"	Each	TKP-42	12/48	TWP-42	12/48
Grill Spatula	4-1/4" x 2-3/16"	* Each	TKP-50	12/72	TWP-50	12/72
Pie Server	4-5/8" x 2-3/8"	* Each	TKP-51	12/72	TWP-51	12/72
Fish Spatula	6-3/4" x 3-1/4"	Each	TKP-60	12/144	TWP-60	12/144
Hamburger Turner	5-1/8" x 2-7/8"	* Each	TKP-61	12/72	TWP-61	12/72
Extra Heavy Turner, Cutting Edge Blade	5" x 6"	* Each	TKP-63	12/48		
Flexible Turner	8-1/4" x 2-7/8"	* Each	TKP-90	12/72	TWP-90	12/48
Flexible Turner (Perforated Blade)	8-1/4" x 2-7/8"	* Each	TKP-91	12/72	TWP-91	12/48
Offset Spatula	3-1/2" x 3/4"	* Each	TKPO-4	24/288	TWPO-4	24/288
Offset Spatula	6-1/2" x 1-5/16"	* Each	TKPO-7	12/144	TWPO-7	12/144
Offset Spatula	8-1/2" x 1-1/2"	* Each	TKPO-9	12/144	TWPO-9	12/144
Bakery Spatula	4" x 3/4"	Each	TKPS-4	24/288	TWPS-4	24/288
Bakery Spatula	7-15/16" x 1-1/4"	Each	TKPS-7	12/144	TWPS-7	12/144
Bakery Spatula	10" x 1-3/8"	Each	TKPS-9	12/144	TWPS-9	12/72

\*Measurement reflects blade size not including offset



TKP-30



TKP-50



TKP-31



TKP-51



TKP-90



TKP-40



TKP-60



TKP-91



TKP-41



TKP-61



TKPO-9



TKP-42



TKP-63



TKPS-9

**Allergen Free**  
SEE PAGE 253 FOR ALLERGEN-FREE PURPLE HANDLES

TKP-SERIES (BLACK) NSF

TWP-SERIES (WHITE) NSF

## WINCO® SPREADER BULK PACK

Practical for many uses around the kitchen, the spreader is now available in bulk. Packed in a convenient display bucket for impulse purchase positioning.

- ◆ Assortment of seven (7) colors included in convenient display bucket
- ◆ 3-5/8" spreader with stainless steel, satin finish blade
- ◆ Slip-free comfort grip
- ◆ NSF listed

ITEM	DESCRIPTION	UOM	CASE
TWP-3135	35-Pcs/Pk	Pack	1/4

## WINCO® SPREADER BULK PACK



Includes 7 handle colors

**NEW**

TWP-3135 NSF

PASTA BASKETS



The Connoisseur premium pasta baskets are made of 18/8 stainless steel that is electro-polished for added corrosion resistance. The extra-heavyweight construction stands up to the constant knocking of its edges when removing pasta. The cylindrical design allows water to flow freely for even cooking and the handles have an open end for hang-drying. The baskets can be used with most pasta cooker machines and standard stock pots.

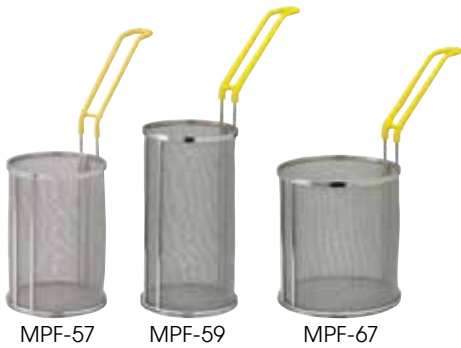

**SUPER FINE MESH CONNOISSEUR PASTA BASKETS**

- ◆ Designed specifically for fine pasta, such as capellini and linguine
- ◆ 18/8 stainless steel, with reinforced frame

ITEM	DESCRIPTION	UOM	CASE
MPF-57	5"Dia x 7"H, Short	Each	1/8
MPF-59	5"Dia x 9"H, Tall	Each	1/8
MPF-67	6-1/2"Dia x 7"H, Wide	Each	1/8

PASTA BOIL BASKETS

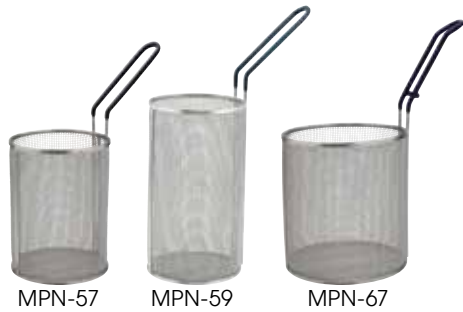

**PASTA BOIL BASKETS**

- ◆ 18/8 stainless steel frame and normal mesh makes it ideal for cooking capellini
- ◆ Fits standard pasta cookers and stock pots

ITEM	DESCRIPTION	UOM	CASE
MPN-57	5-1/4" Dia x 7"H, Short	Each	2/8
MPN-59	5" Dia x 9"H, Tall	Each	2/8
MPN-67	6-1/2" Dia x 7"H, Wide	Each	2/6

BULK PASTA BASKET

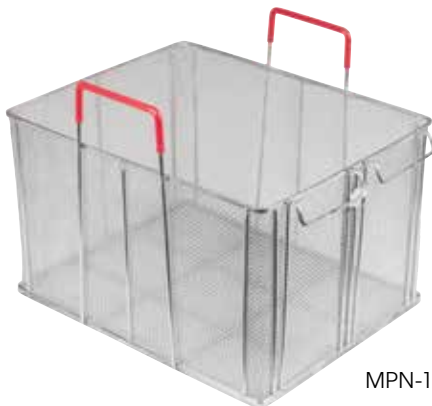

MPN-1613

**BULK PASTA/IMMERSION BASKET**

- ◆ Durable 18/8 stainless steel
- ◆ Plastic coated handles rated for temperatures up to 250°F (120°C)
- ◆ Suitable for cooking all types of pasta in bulk
- ◆ Fits standard cookers

ITEM	DESCRIPTION	UOM	CASE
MPN-1613	16-1/4"L x 12-7/8"W x 10"H	Each	2



### HOLLOW HANDLE BOUILLON STRAINERS

- ◆ Extra-fine mesh

ITEM	DESCRIPTION	UOM	CASE
CCB-8	8"	Each	1/6
CCB-8R	8", Reinforced	Each	1/6
CCB-10	10"	Each	1/6
CCB-10R	10", Reinforced	Each	1/6

Replaces former CCBH-Series

### STAINLESS STEEL STRAINERS



CCB-8



CCB-8R



CCS-10C



CCS-10F

### CHINA CAP STRAINERS, STAINLESS STEEL

- ◆ Perforated 18/8 stainless steel with welded handle

ITEM	DESCRIPTION	UOM	CASE
CCS-8F	8" Fine	Each	12
CCS-10F	10" Fine	Each	12
CCS-12F	12" Fine	Each	12
CCS-8C	8" Coarse	Each	12
CCS-10C	10" Coarse	Each	12
CCS-12C	12" Coarse	Each	12

### CHINOIS PESTLE

- ◆ Solid wood construction
- ◆ Press, crush and push mixtures through a bouillon strainer
- ◆ Fits standard size strainers

ITEM	DESCRIPTION	UOM	CASE
WPST-13	13-7/8"L x 3-1/8"Dia	Each	6/24

### WOODEN PESTLE



WPST-13



### SCOOP COLANDER

Scoop and strain pasta or vegetables with the scoop colander. With its long handle, the scoop colander is ideal for easily lifting food out of pots, woks or friers.

- ◆ 18/8 stainless steel

ITEM	DESCRIPTION	UOM	CASE
CODS-7	7"L x 4"W, 11"L Hdl	Each	4/16

### SCOOP COLANDER

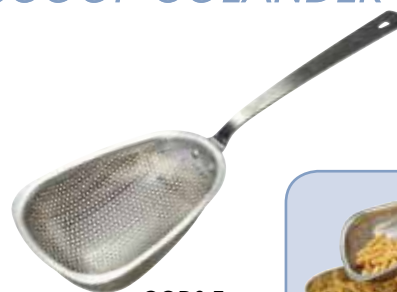

CODS-7





## SKIMMERS



### HEAVY-DUTY SKIMMER

◆ One-piece stainless steel construction

ITEM	DESCRIPTION	HANDLE	UOM	CASE
SCS-6H	6-1/4"Dia	16"	Each	12/72

### SKIMMERS

◆ Stainless steel

ITEM	DESCRIPTION	HANDLE	UOM	CASE
SCS-5	4-1/2"Dia	13"	Each	12/120
SCS-6	5-3/4"Dia	13-1/2"	Each	12/120

### EXTRA STRENGTH SHORT HANDLE SKIMMER

◆ Stainless steel

ITEM	DESCRIPTION	UOM	CASE
SC-12	12"Dia	Each	12/24

## WIRE SKIMMERS

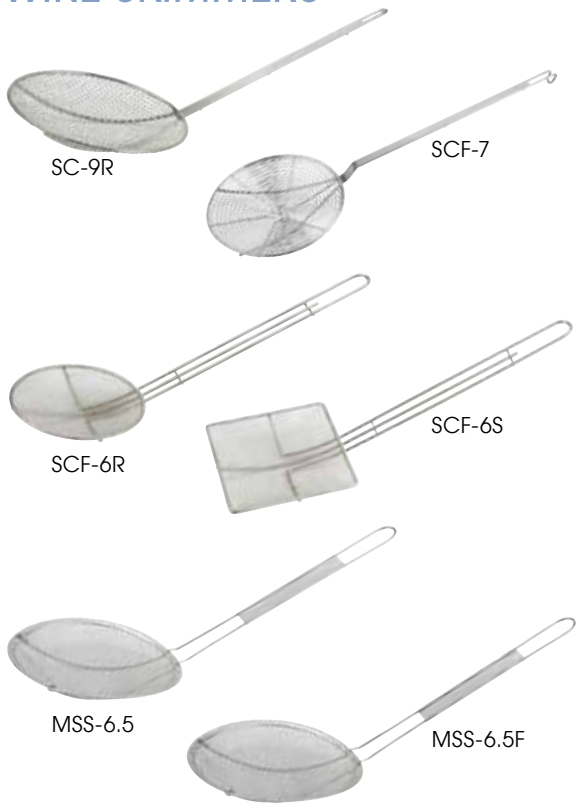

### WIRE SKIMMERS

◆ Nickel plated

ITEM	DESCRIPTION	HANDLE	UOM	CASE
SC-5R	5"Dia	13"	Each	12/36
SC-6R	6"Dia	13"	Each	12/36
SC-7R	7"Dia	13"	Each	12/36
SC-8R	8"Dia	13"	Each	12/24
SC-9R	9"Dia	13"	Each	12/24
SC-12R	12"Dia	13"	Each	12/24

### SPIRAL SKIMMERS

◆ Nickel plated

ITEM	DESCRIPTION	HANDLE	UOM	CASE
SCF-7	7"Dia	14"	Each	12/48
SCF-9	9"Dia	14"	Each	12/48

### MESH SKIMMERS

◆ Nickel plated

ITEM	DESCRIPTION	HANDLE	UOM	CASE
SCF-6R	6-1/2"Dia	13"	Each	12/48
SCF-6S	6-3/4" x 6-3/4"	13"	Each	12/48

### SINGLE MESH SKIMMERS

◆ Stainless steel

ITEM	DESCRIPTION	HANDLE	UOM	CASE
MSS-6F	6"Dia, Fine	13"	Each	12/120
MSS-6.5F	6-1/2"Dia, Fine	13"	Each	12/120
MSS-6	6"Dia, Coarse	13"	Each	12/120
MSS-6.5	6-1/2"Dia, Coarse	13"	Each	12/120

## STRAINERS



### STAINLESS STEEL SPAGHETTI STRAINER

◆ 18/8 stainless steel

◆ Tri-riveted handle with helper hook that rests over rim of pot

ITEM	DESCRIPTION	HANDLE	UOM	CASE
SSS-3	8-1/2"Dia	8"	Each	6/24

### ALUMINUM SPAGHETTI STRAINERS

ITEM	DESCRIPTION	HANDLE	UOM	CASE
ASS-09	9"Dia	7-1/2"	Each	12
ASS-10	10"Dia	6-3/4"	Each	12

**REINFORCED DOUBLE MESH**

◆ Nickel plated

ITEM	DESCRIPTION	DIA	UOM	CASE
MST-10RB	Flat Handle	10-1/2"	Each	12
MST-1010D	Round Handle	10-1/2"	Each	12
MST-12D	Round Handle	12"	Each	6
MST-14D	Round Handle	14"	Each	6

**FINE MESH STRAINERS**

◆ Stainless steel

ITEM	DESCRIPTION	DIA	UOM	CASE
MS3A-8D	Double Mesh	8"	Each	12/48
MS3A-8S	Single Mesh	8"	Each	12/48
MS2K-10D	Double Mesh	10-1/2"	Each	12/48
MS2K-10S	Single Mesh	10-1/2"	Each	12/48

**TINNED DOUBLE MESH**

ITEM	DESCRIPTION	DIA	UOM	CASE
MSTF-6D	Fine	6-1/4"	Each	12/96
MSTF-8D	Fine	8"	Each	12/48
MSTF-10D	Fine	10-1/4"	Each	12/24
MST-6D	Medium	6-1/4"	Each	12/96
MST-8D	Medium	8"	Each	12/48
MST-10D	Medium	10-1/2"	Each	12/24

**TINNED SINGLE MESH**

ITEM	DESCRIPTION	DIA	UOM	CASE
MSTF-6S	Fine	6-1/4"	Each	12/96
MSTF-8S	Fine	8"	Each	12/48
MSTF-10S	Fine	10-1/4"	Each	12/24
MST-6S	Medium	6-1/4"	Each	12/96
MST-8S	Medium	8"	Each	12/48
MST-10S	Medium	10-1/4"	Each	12/24

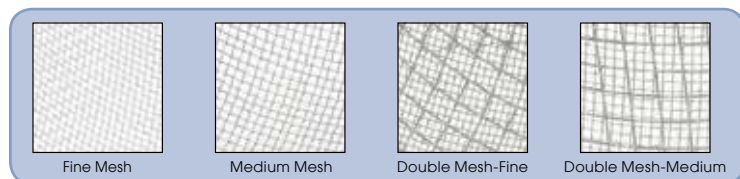

**SINGLE MESH STRAINER**

ITEM	DESCRIPTION	DIA	UOM	CASE
MSH-5	Deep Bowl	5-1/2"	Each	12/48

**CULINARY BASKETS**

◆ Nickel plated steel

ITEM	DESCRIPTION	DIA	UOM	CASE
MSB-08	Coarse Mesh	8"	Each	12/36
MSB-08M	Medium Mesh	8"	Each	12/36
MSB-08F	Fine Mesh	8"	Each	12/36
MSB-10	Coarse Mesh	10"	Each	12/36
MSB-10M	Medium Mesh	10"	Each	12/36
MSB-10F	Fine Mesh	10"	Each	12/36
MSB-12	Coarse Mesh	12"	Each	30
MSB-12M	Medium Mesh	12"	Each	30
MSB-12F	Fine Mesh	12"	Each	30

**STAINLESS STEEL MESH STRAINERS**



**CULINARY BASKETS**



DISPENSERS & FUNNELS



OC-24



PBST-1.5



SF-6



SF-6S



SAF-05

SAF-2

SAF-4



SAF-1ST



SAF-1ST inside detail



SAF-4



PF-32



OIL CAN WITH BRASS COVER

ITEM	DESCRIPTION	UOM	CASE
OC-24	24 Oz	Each	1/12



PLASTIC BASTER

◆ 1-1/2 oz capacity with rubber bulb

ITEM	DESCRIPTION	UOM	CASE
PBST-1.5	7-1/2" Tube, 11" O.L.	Each	12/72

WIDE-MOUTH FUNNELS & REMOVABLE STRAINERS

◆ Stainless steel mirror finish for SF-5 and SF-6

ITEM	DESCRIPTION	UOM	CASE
SF-5	5" Funnel	Each	12/72
SF-6	5-3/4" Funnel	Each	12/72
SF-6S	Strainer for SF-6	Each	120/480

SPUN ALUMINUM FUNNELS

◆ Made of one-piece spun aluminum

ITEM	DESCRIPTION	UOM	CASE
SAF-05	1/2 Pt, 3-7/8"Dia x 3-5/8"H	Each	12/192
SAF-1ST	1 Pt w/Strainer, 5-1/4"Dia x 5-1/4"H	Each	6/150
SAF-2	1 Qt, 7"Dia x 6-5/8"H	Each	6/54
SAF-4	2 Qt, 9-1/8"Dia x 7-3/4"H	Each	6/72

PLASTIC FUNNELS

ITEM	DESCRIPTION	SIZE	UOM	CASE
PF-8	8 Oz	4"Dia	Each	6/324
PF-16	16 Oz	5-1/4"Dia	Each	6/324
PF-32	32 Oz	6-1/4"Dia	Each	6/216

### BUTTER ROLLER

- ◆ Standard 1/6 size steam table pan, fits into 7"L x 6-3/8"W size opening
- ◆ Reduces butter and dressing waste
- ◆ Roller is removable for easy cleaning
- ◆ Spreads butter quickly and evenly
- ◆ Sturdy stainless steel construction
- ◆ Designed for countertop access
- ◆ Provides safe and sanitary food preparation

ITEM	DESCRIPTION	UOM	CASE
SPBR-604	7"L x 6-3/8"W	Each	1/6

### DISPENSERS



SPBR-604

### WIDE-MOUTH SQUEEZE BOTTLES

- ◆ Open tip, no cutting required, easy to refill
- ◆ Each pack contains six (6) pieces
- ◆ BPA-free

ITEM	DESCRIPTION	UOM	CASE
PSW-12	12 Oz, Clear	Pack	1/12
PSW-12R	12 Oz, Red	Pack	1/12
PSW-12Y	12 Oz, Yellow	Pack	1/12
PSW-16	16 Oz, Clear	Pack	1/8
PSW-16R	16 Oz, Red	Pack	1/8
PSW-16Y	16 Oz, Yellow	Pack	1/8
PSW-24	24 Oz, Clear	Pack	1/8
PSW-24R	24 Oz, Red	Pack	1/8
PSW-24Y	24 Oz, Yellow	Pack	1/8
PSW-32	32 Oz, Clear	Pack	1/6
PSW-32R	32 Oz, Red	Pack	1/6
PSW-32Y	32 Oz, Yellow	Pack	1/6



Wide-mouth squeeze bottle



6 per pack



PSW-24

PSW-SERIES



### REGULAR SQUEEZE BOTTLES

- ◆ Open tip, no need for cutting
- ◆ Each pack contains six (6) pieces

ITEM	DESCRIPTION	UOM	CASE
PSB-08C	8 Oz, Clear	Pack	12
PSB-08R	8 Oz, Red	Pack	1/12
PSB-08Y	8 Oz, Yellow	Pack	1/12
PSB-12C	12 Oz, Clear	Pack	1/12
PSB-12R	12 Oz, Red	Pack	1/12
PSB-12Y	12 Oz, Yellow	Pack	1/12
PSB-24C	24 Oz, Clear	Pack	1/6
PSB-24R	24 Oz, Red	Pack	1/6
PSB-24Y	24 Oz, Yellow	Pack	1/6



PSB-SERIES



### SYRUP DISPENSERS

- ◆ Stainless steel dispenser slide prevents dripping
- ◆ Ideal for batter, dressing, juice
- ◆ BPA-free

ITEM	DESCRIPTION	UOM	CASE
PSUD-32	32 Oz	Each	12
PSUD-48	48 Oz	Each	12
PSUD-WLid	Lid, White	Each	24/144
PSUD-RLid	Lid, Red	Each	24/144
PSUD-TLid	Lid, Tan	Each	24/144



PSUD-RLID

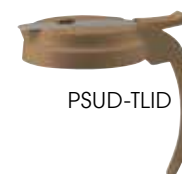

PSUD-TLID



PSUD-48



PSUD-32





## SCOOPS



IS-4



SSC-3



AS-85



ASFB-SERIES



**NSF** PS-SERIES



PS-64

### STAINLESS STEEL SCOOPS

ITEM	DESCRIPTION	UOM	CASE
IS-4	4 Oz Ice Scoop	Each	12/144

### STAINLESS STEEL SCOOPS

ITEM	DESCRIPTION	UOM	CASE
SSC-2	2 Qt Utility Scoop	Each	6/24
SSC-3	3 Qt Utility Scoop	Each	6/18

### ALUMINUM SCOOPS

◆ Hand wash only

ITEM	DESCRIPTION	UOM	CASE
AS-5	5 Oz	Each	12/60
AS-12	12 Oz	Each	12/60
AS-24	24 Oz	Each	12/60
AS-38	38 Oz	Each	12/48
AS-58	58 Oz	Each	12/36
AS-85	85 Oz	Each	12/24

### ALUMINUM FLAT BOTTOM SCOOPS

◆ Hand wash only

ITEM	DESCRIPTION	UOM	CASE
ASFB-4	4 Oz	Each	12/72
ASFB-7	7 Oz	Each	12/72
ASFB-16	16 Oz	Each	12/72
ASFB-24	24 Oz	Each	12/48

### POLYCARBONATE SCOOPS

◆ NSF listed

ITEM	DESCRIPTION	UOM	CASE
PS-5	5 Oz	Each	24/144
PS-10	10 Oz	Each	24/144
PS-20	20 Oz	Each	24/144
PS-32	32 Oz	Each	12/72
PS-50	50 Oz	Each	12/72

### POLYPROPYLENE SCOOP

ITEM	DESCRIPTION	UOM	CASE
PS-64	64 Oz, White	Each	12/48

## SCOOP HOLDERS



WHW-4



WHW-7



Scoops sold separately

### SCOOP HOLDERS

- ◆ Mounted to the wall for ease of reach and sanitation
- ◆ Keeps scoops off food prep surfaces
- ◆ Plastic coated wire

ITEM	DESCRIPTION	SIZE (L X W)	UOM	CASE
WHW-4	Holds AS-12, AS-24, PS-10 & PS-20	4-1/4" x 5-3/8"	Each	12/48
WHW-7	Holds AS-38, AS-58, PS-32 & PS-50	7" x 8"	Each	12/48



## ERGONOMIC KITCHEN TOOLS

- ◆ Made of stainless steel with a comfortable non-slip soft-grip handle
- ◆ Dishwasher safe
- ◆ NSF listed

ITEM	DESCRIPTION	UOM	CASE
VP-300	Straight Edge "Y" Peeler	Each	12/72
VP-301	Serrated Edge "Y" Peeler	Each	12/72
VP-302	Julienne Peeler	Each	12/72
VP-303	Straight Peeler	Each	12/72
VP-304	Serrated Edge Straight Peeler	Each	12/72
VP-305	Apple Corer	Each	12/72
VP-306	Zester/Lemon Peeler	Each	12/72
VP-307	Melon Baller	Each	12/72
VP-308	Tomato Stem Corer	Each	12/72
VP-309	Cheese Plane	Each	12/72
VP-310	Butter Curler	Each	12/72
VP-314	2-7/8" Oyster/Clam Knife	Each	12/72
VP-315	Small Pizza Cutter 2-1/2" Wheel Blade	Each	12/72
VP-316	Large Pizza Cutter 4" Wheel Blade	Each	12/72
VP-311	Grater w/1.5mm Dia Holes	Each	12/72
VP-312	Grater w/3mm Dia Holes	Each	12/72
VP-313	Grater w/6mm Dia Holes	Each	12/72



**EXTRA STRENGTH  
WIRE FRAME  
RESISTS BENDING**

## ERGONOMIC KITCHEN TOOLS

VP-SERIES **NSF**



## ROTARY CHEESE GRATERS



### STAINLESS STEEL CHEESE GRATER

- ◆ 18/8 stainless steel rotary grater with one drum for grating fine cheeses

ITEM	DESCRIPTION	UOM	CASE
GRTS-1	8-1/4"L x 4-3/4"W x 3-3/8"H	Each	12/36



### PLASTIC CHEESE GRATER

- ◆ Ideal for grating hard cheese or chocolate
- ◆ Includes two (2) interchangeable drums for fine and coarse grating
- ◆ Dishwasher safe

ITEM	DESCRIPTION	UOM	CASE
PRTS-2	7"L x 3-1/2"W x 4-3/8"H	Each	6/24

## GRATERS WITH COVER

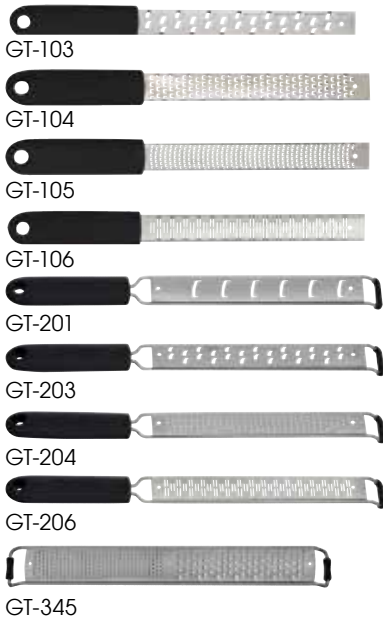

**MICRO ETCHED BLADE**



### GRATERS WITH COVER

- ◆ Etched 18/8 stainless steel blade, black soft-grip handle
- ◆ Anti-corrosive and durable
- ◆ Anti-slip feet (only available on GT-201/203/204/206)
- ◆ Two blade types in one product (GT-345 only)
- ◆ Dishwasher safe

ITEM	DESCRIPTION	UOM	CASE
GT-103	Medium Coarse Blade	Each	12/72
GT-104	Zester Blade	Each	12/72
GT-105	Fine Blade	Each	12/72
GT-106	Ribbon Blade	Each	12/72
GT-201	Slicer Blade & Anti-Slip Feet	Each	12/72
GT-203	Medium Coarse Blade & Anti-Slip Feet	Each	12/72
GT-204	Zester Blade & Anti-Slip Feet	Each	12/72
GT-206	Ribbon Blade & Anti-Slip Feet	Each	12/72
GT-345	Half Zester / Half Fine Blade & Anti-Slip Feet	Each	12/72



	GT-100 series, with soft grip handle, one side blade (one type per item)	GT-200 series, with additional anti-slip feet feature and all features of GT-100 series	GT-301 with anti-slip feet and 2 types of blade on one item	GT-401 with 5 sides of different blades and soft grip handle
<b>SLICER</b>		GT-201		✓
<b>MEDIUM COARSE</b>	GT-103	GT-203		✓
<b>ZESTER</b>	GT-104	GT-204	✓	✓
<b>FINE</b>	GT-105		✓	✓
<b>RIBBON</b>	GT-106	GT-206		✓

## BOX GRATERS



**MICRO ETCHED BLADE**



### ERGONOMIC BOX GRATER

- ◆ Etched 18/8 stainless steel blade, black soft-grip handles

ITEM	DESCRIPTION	UOM	CASE
GT-401	5-Sided Grater: Slicer, Medium Coarse, Zester, Fine, Ribbon	Each	12/48

### STAINLESS STEEL BOX GRATERS

ITEM	DESCRIPTION	SIZE	UOM	CASE
SQG-1	Tapered Grater	4" x 3" x 9"	Each	12/72
SQG-4	Box Grater	9" x 4"	Each	12/24

**PINEAPPLE CORER**

- ◆ Heavy-duty stainless steel cutting shaft
- ◆ Cores and rings pineapple with a simple twist, extracting fruit without eyes or peels attached
- ◆ Includes cap to protect serrated teeth when not in use

ITEM	DESCRIPTION	UOM	CASE
SPC-3	Pineapple Corer	Each	6/24

**FRUIT PREP TOOLS**



SPC-3

**CHERRY CORER**

- ◆ Quickly and easily remove cherry or olive pits
- ◆ Stainless steel
- ◆ Dishwasher safe

ITEM	DESCRIPTION	UOM	CASE
SCC-5	5-1/4" O.L.	Each	12/144



SCC-5

**APPLE DIVIDER/CORER**

- ◆ Aluminum

ITEM	DESCRIPTION	UOM	CASE
AAD-12	4-3/8"Dia	Each	12/48



AAD-12

**TOMATO STEM CORER**

ITEM	DESCRIPTION	UOM	CASE
TSC-2	Stainless Steel	Doz	24/144



TSC-2

**MELON BALLER**

ITEM	DESCRIPTION	UOM	CASE
MB-1	2-Sided, Wooden Hdl	Each	24/240



MB-1

**GRAPEFRUIT SPOON**

*Complete any table setting with this grapefruit spoon. The serrated edge cuts easily into any citrus fruit, which also makes it ideal for food prep.*

- ◆ Stainless steel

ITEM	DESCRIPTION	UOM	CASE
SRS-6	6-1/4" O.L.	Doz	1/25



SRS-6

**MANUAL JUICE SQUEEZER**

- ◆ Stainless steel

ITEM	DESCRIPTION	UOM	CASE
JC-4	5"Dia	Each	24



JC-4

**HANDHELD CITRUS SQUEEZERS**

*Extract all the juice without the rind, pulp or seeds.*

- ◆ Made from aluminum with baked-on enamel coating
- ◆ Place citrus half with cut side down in juicer and extract
- ◆ Dishwasher safe, long lasting, won't absorb odors, as well as resistant to moisture, heat and stains

ITEM	DESCRIPTION	UOM	CASE
LS-8G	2-1/2"Dia	Each	6/48
LS-9O	3-1/2"Dia	Each	9/36
LS-9Y	3"Dia	Each	6/48

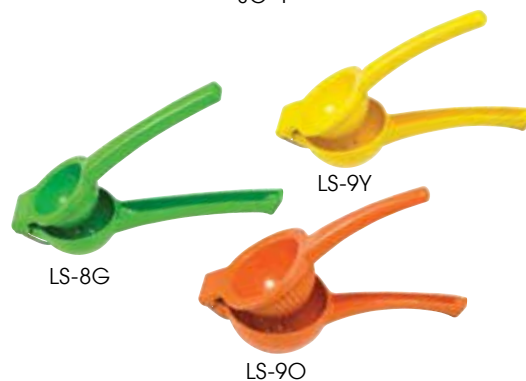

LS-8G

LS-9Y

LS-9O



**SHEARS**



KS-06



Detachable



KS-01

**KITCHEN SHEARS**

ITEM	DESCRIPTION	UOM	CASE
KS-01	All purpose	Each	12/120
KS-06*	All purpose, Detachable	Each	12/72

\*Replaces KS-04



KS-02



KS-03

**POULTRY SHEARS**

ITEM	DESCRIPTION	UOM	CASE
KS-02	Stainless Steel, Soft PP Hdl	Each	12/72
KS-03	Stainless Steel	Each	10/50



Easily cut, chop, and mince herbs



KS-05

**HERB SHEARS**

Chopping fresh herbs is now easy with these shears featuring five (5) durable stainless steel blades.

- ◆ Works well on basil, thyme, mint and more
- ◆ Ideal for cutting, chopping and mincing herbs
- ◆ Comfortable PP and TPR handles for easy grip

ITEM	DESCRIPTION	UOM	CASE
KS-05	5-Layer Blade	Each	12/72

**SPECIALTY UTENSILS**



CS-44P



CS-44W

**WIRE CHEESE SLICERS**

- ◆ Provides a smoother cut than cheese knives
- ◆ 44" long 18/8 stainless steel wire
- ◆ Customized control over slicing thickness and angle
- ◆ Easy cleanup

ITEM	DESCRIPTION	UOM	CASE
CS-44P	Polyethylene Hdl	Each	24/144
CS-44W	Wooden Hdl	Each	24/144



PLK-11G

**PLASTIC LETTUCE KNIFE**

- ◆ Prevents oxidation so lettuce will not turn brown
- ◆ Serrated edges are also ideal for cutting fruits, and slicing bread and cake
- ◆ Safe to use on non-stick cookware
- ◆ Dishwasher safe

ITEM	DESCRIPTION	UOM	CASE
PLK-11G	11-1/2"L	Each	24/144



POA-8

**PAIL OPENER**

- ◆ Aluminum

ITEM	DESCRIPTION	UOM	CASE
POA-8	8-7/16"L x 1-7/16"W x 2-3/4"H	Each	6/72

**GARLIC PRESS & SLICER**

- ◆ All-in-one garlic press and slicer
- ◆ Made of rust-resistant aluminum alloy with a non-stick coating
- ◆ Simplify cleaning with tool attached to inside of handle
- ◆ Easy to store and convenient to use
- ◆ Solid, sturdy, comfortable-to-squeeze handles

ITEM	DESCRIPTION	UOM	CASE
GP-2	Aluminum Alloy, Non-Stick	Each	1/72

**GARLIC PRESS**

ITEM	DESCRIPTION	UOM	CASE
GP-1	Aluminum Alloy	Each	12/96

**NUT CRACKER**

- ◆ Stainless steel

ITEM	DESCRIPTION	UOM	CASE
LC-04	4-3/4"	Each	24/144

**VEGETABLE PEELERS**

ITEM	DESCRIPTION	UOM	CASE
VP-1	Nickel Plated Handle	Doz	2/24
VP-2	Plastic Handle	Doz	2/24

**SERRATOR**

- ◆ Stainless steel

ITEM	DESCRIPTION	UOM	CASE
SRT-7	7" w/Wooden Hdl	Each	12/72

**EGG SEPARATOR**

- ◆ 8-1/2" easy-grip hollow handle
- ◆ Stainless steel handle and blade
- ◆ Easy to separate an egg white from its yolk
- ◆ Great for preparing crême brûlée, pudding, tiramisu and soufflé
- ◆ Dishwasher safe

ITEM	DESCRIPTION	UOM	CASE
SES-3	2-7/8"Dia	Each	24/96

**EGG SLICERS**

- ◆ Square egg slicer's stainless steel wires are clamped into the wire casing
- ◆ No risk of wires slipping out of the pegs
- ◆ Aluminum

ITEM	DESCRIPTION	UOM	CASE
AES-1	Round	Each	12/144
AES-4	Square	Each	1/96

**SPECIALTY UTENSILS**



GP-2



GP-1



LC-04



VP-1



VP-2



SRT-7



SES-3



AES-1



AES-4

## MEAT PREP TOOLS



MT-4

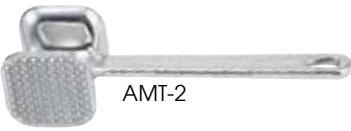

AMT-2



AMT-3



AMT-4

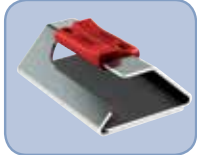

Nested together for additional weight



**NEW**

AVAILABLE IN  
FEBRUARY 2018

NSF SWS-74



SWA-5



SWA-2



HP-4



PSM-SERIES



SKO-SERIES



WSK-10

## ALUMINUM MEAT TENDERIZERS

ITEM	DESCRIPTION	HEAD SIZE	O.L.	UOM	CASE
MT-4	2-Sided, Wooden Hdl.	3" x 2-1/2"	13"	Each	12/24
AMT-2	2-Sided	3" x 3"	10-1/2"	Each	1/36
AMT-3	3-Sided	3" x 2-3/8"	11"	Each	1/20
AMT-4	2-Sided, Heavy Alu	4-1/4" x 2-3/4"	12-3/4"	Each	1/12



## ONE-PIECE STEAK WEIGHT WITH SILICONE SLEEVE

- ◆ Unique one-piece design
- ◆ Can be stacked/nested together for heavier weight
- ◆ Handle is heat-resistant up to 450°F (230°C)

ITEM	DESCRIPTION	SIZE	UOM	CASE
SWS-74	2 Lb, Stainless Steel	4" x 7.5"	Each	1/12

## STEAK WEIGHTS

- ◆ Press meats for even cooking

ITEM	DESCRIPTION	SIZE	UOM	CASE
SWA-1	1 Lb Cast Alu	4-1/4" x 8-1/4"	Each	1/12
SWA-5	1 Lb Cast Alu	5-1/4" x 9"	Each	1/12
SWA-2	2 Lbs Cast Iron	4-1/4" x 8-1/4"	Each	6
SWA-9	2.5 Lbs Cast Iron	5-1/4" x 9"	Each	6

## HAMBURGER PRESS

- ◆ Adjustable patty thickness

ITEM	DESCRIPTION	UOM	CASE
HP-4	4-1/2"Dia	Each	12/36



## STEAK MARKERS

- ◆ Each bag contains 1,000 pieces
- ◆ 2.0mm thickness
- ◆ Labeled for rare, medium rare, medium, medium well and well done

ITEM	DESCRIPTION	COLOR	UOM	CASE
PSM-R	Rare	Red	Bag	1/5
PSM-MR	Medium Rare	Pink	Bag	1/5
PSM-M	Medium	White	Bag	1/5
PSM-MW	Medium-Well	Yellow	Bag	1/5
PSM-W	Well Done	Tan	Bag	1/5



## OVAL STAINLESS STEEL SKEWERS

- ◆ Flat needle keeps food from turning while cooking/grilling

ITEM	DESCRIPTION	UOM	CASE
SKO-8	8"	Doz	5/100
SKO-10	10"	Doz	5/60
SKO-12	12"	Doz	5/60



## BAMBOO SKEWERS

- ◆ Each bag contains 100 pieces

ITEM	DESCRIPTION	UOM	CASE
WSK-06	6"	Bag	30/240
WSK-08	8"	Bag	30/240
WSK-10	10"	Bag	30/120
WSK-12	12"	Bag	30/120

## SEAFOOD PREPARATION



### FISH BONE TWEEZERS

- ◆ Ideal for removing fish pin bones
- ◆ Stainless steel; dishwasher safe

ITEM	DESCRIPTION	UOM	CASE
TTG5-2PK	2-Pcs/Pk	Pack	12/144



### SHRIMP DEVEINER

- ◆ Devein and peel shrimp with one tool
- ◆ Aluminum

ITEM	DESCRIPTION	UOM	CASE
SDA-7	2-Pcs/Pk	Pack	12/144



### SCALE PEELER

- ◆ Stainless steel
- ◆ NSF listed

ITEM	DESCRIPTION	UOM	CASE
FSP-9	9-1/2"L	Each	60/240

### LOBSTER CRACKERS

ITEM	DESCRIPTION	SIZE	UOM	CASE
LC-01	Stainless Steel	6"	Each	12/72
LC-03	Chrome Plated, Large	6"	Each	12/144
LC-04	Nut / Lobster Cracker	4-3/4"	Each	24/144
LC-05	Zinc Alloy	6"	Each	12/72
LC-85	Zinc Alloy, Carded	6"	Each	12/72



### SEAFOOD PICKS

- ◆ 18/8 stainless steel with decorative lobster stamp
- ◆ Narrow two-tine fork designed to effortlessly reach more shellfish meat
- ◆ Each pack contains four (4) pieces

ITEM	DESCRIPTION	UOM	CASE
LC-08	8"L x 3/4"W	Pack	30/120



TTG5-2PK

2PCS PER PACK

AVAILABLE IN FEBRUARY 2018



LC-85



SDA-7



FSP-9



LC-01



LC-03



LC-04



LC-05



LC-08

### OYSTER/CLAM KNIVES



ITEM	DESCRIPTION	SIZE	UOM	CASE
VP-314	2-7/8" Blade, Soft Rubber Grip NSF	7-5/8" O.L.	Each	12/72
KCL-5P	3" Blade, Plastic Handle, NSF	6-3/4" O.L.	Each	12/72
KCL-1	2-3/4" Blade, Wooden Handle	5-7/8" O.L.	Each	12/72
KCL-2	2-7/8" Blade, Wooden Handle	6-5/8" O.L.	Each	12/72
KCL-3	3-1/2" Blade, Wooden Handle	7-1/2" O.L.	Each	12/72



KCL-3



KCL-2



VP-314



KCL-5P



KCL-1

### OYSTER/CLAM KNIVES



### STAINLESS STEEL PROTECTIVE MESH GLOVES

Made for meat processing, the rust-resistant 304L stainless steel rings that form these mesh gloves protect hands from cuts and punctures while deboning and butchering. Each glove is reversible and is fixed with a wrist strap that features a snap and cinch fastener to keep it secure.

- ◆ Lightweight and non-corrosive
- ◆ Wrist length

ITEM	DESCRIPTION	SIZE	UOM	CASE
PMG-1S	White Strap	Small	Each	10/50
PMG-1M	Red Strap	Medium	Each	10/50
PMG-1L	Blue Strap	Large	Each	50

### PROTECTIVE GLOVES



Closure Detail



Mesh Detail



PMG-1L





GRILL TOOLS



AVAILABLE IN FEBRUARY 2018

NEW



KFP-62

KFP-71

KFP-121

KFP-140

KFP-180

NSF KFP-SERIES



KPF-612



KPF-210



ACERO FORGED COOK'S FORKS

◆ Extra heavyweight with POM handle

ITEM	DESCRIPTION	PRONGS	UOM	CASE
KFP-62	Curved, 12" w/Hdl	6"L	Each	6/36
KFP-71	Straight, 12" w/Hdl	6"L	Each	6/36
KFP-121	Curved, 12" w/Hdl	4"L	Each	6/36
KFP-140	Curved, 14" w/Hdl	5"L	Each	6/36
KFP-180	Curved, 18" w/Hdl	5"L	Each	6/36

POT FORKS

ITEM	DESCRIPTION	UOM	CASE
KPF-612	12-5/8" O.L.	Each	12/120
KPF-210	21-7/8" O.L.	Each	12/72



PANCAKE TURNER

◆ Heat resistant up to 608°F (320°C)

◆ Nylon blade with 18/8 stainless steel handle

ITEM	DESCRIPTION	UOM	CASE
STN-3	15-7/16" O.L.	Each	24/48



STN-3



STN-6

STN-8

SERVING TURNERS

◆ Stainless steel

ITEM	DESCRIPTION	UOM	CASE
STN-6	14" O.L., Solid	Each	12/120
STN-8	14" O.L., Slotted	Each	12/120

ALUMINUM PIZZA/BURGER PEEL

◆ 14 gauge, 1.6mm thick

◆ 11" handle, 20" overall length

ITEM	DESCRIPTION	UOM	CASE
APP-20	9"L x 6-3/4"W Blade	Each	12/48



APP-20

### EGG RINGS

- ◆ Stainless steel

ITEM	DESCRIPTION	UOM	CASE
EGR-3	3" Dia x 1"L	Each	12/144
EGR-4	4" Dia x 1"L	Each	12/144
EGR-5	5" Dia x 1"L	Each	12/144
EGR-6	6" Dia x 1"L	Each	12/96
EGRS-44	4" Square x 1"	Each	12/144

### GRILL TOOLS



EGR-6

EGRS-44

### GRILL BASTING COVERS

- ◆ Contain mess and splatter from frying food on the grill
- ◆ Cover entrée to keep it warm until ready to serve
- ◆ Aluminum with Bakelite knob handle

ITEM	DESCRIPTION	UOM	CASE
ADBC-7	7"Dia	Each	6/12
ADBC-8	8"Dia	Each	6/12
ADBC-9	9"Dia	Each	6/12
ADBC-10	10"Dia	Each	6/12



ADBC-7

### DOMED GRILL BASTING COVER

- ◆ Used to cover hamburgers and hold in steam for thorough, even cooking
- ◆ Aluminum

ITEM	DESCRIPTION	UOM	CASE
AHC-6	6"Dia	Each	12/48



AHC-6

### FRENCH FRY BAGGERS

ITEM	DESCRIPTION	COLOR	UOM	CASE
FFB-1R	Right Handle	Black	Each	12/36
FFB-2	Dual Handles	Black	Each	12/36

### FRYER ACCESSORIES



FFB-2

FFBN-1R

FFBN-SERIES 

### FRYER FILTER STAND & FILTER

- ◆ Cloth filters are heat resistant up to 392°F (200°C)

ITEM	DESCRIPTION	UOM	CASE
FF-10	10" Fryer Filter Stand	Each	20
FF-RC	Rayon Cloth Filter Cones (10-Pcs/Box)	Box	1/60

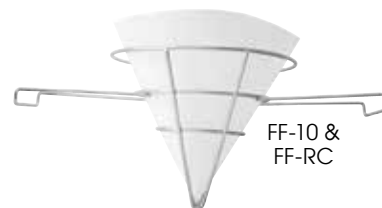

FF-10 & FF-RC

### FRYER SCREEN

- ◆ For use with: Imperial: IFS-40; DCS: FRFG-40; American Range: AF-45; PITCO: 35C and 45C
- ◆ Chrome-plated

ITEM	DESCRIPTION	UOM	CASE
FS-1313	13" x 13"	Each	12/48

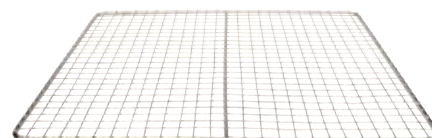

FS-1313

The **SIGNATURE LOOK**  
GREAT QUALITY. GREAT VALUE.



**SIGNATURE CHEF APPAREL**

*Keep your staff looking sharp in the kitchen with the Signature Chef clothing collection.*

- ◆ Short-sleeved chef shirts feature a chest pocket and snap-button fasteners
- ◆ Lightweight, 65/35 poly-cotton blend
- ◆ Available in black and white



UNF-1KL

**BLACK CHEF SHIRTS**

ITEM	COLOR	SIZE	UOM	CASE
UNF-1KS	Black	S	Each	1/24
UNF-1KM	Black	M	Each	1/24
UNF-1KL	Black	L	Each	1/24
UNF-1KXL	Black	XL	Each	1/24
UNF-1KXXL	Black	2X	Each	1/24



UNF-1WL

**WHITE CHEF SHIRTS**

ITEM	COLOR	SIZE	UOM	CASE
UNF-1WS	White	S	Each	1/24
UNF-1WM	White	M	Each	1/24
UNF-1WL	White	L	Each	1/24
UNF-1WXL	White	XL	Each	1/24
UNF-1WXXL	White	2X	Each	1/24

SIGNATURE CHEF APPAREL



**BLACK CHEF JACKETS**

- ◆ Tapered fit
- ◆ Double breasted with pen/thermometer pocket
- ◆ 65/35 poly-cotton blend

ITEM	COLOR	SIZE	UOM	CASE
UNF-5KS	Black	S	Each	1/24
UNF-5KM	Black	M	Each	1/24
UNF-5KL	Black	L	Each	1/24
UNF-5KXL	Black	XL	Each	1/24
UNF-5KXXL	Black	2X	Each	1/24

**WHITE CHEF JACKETS**

- ◆ Universal fit
- ◆ Double breasted with pen/thermometer pocket
- ◆ 65/35 poly-cotton blend

ITEM	COLOR	SIZE	UOM	CASE
UNF-5WS	White	S	Each	1/24
UNF-5WM	White	M	Each	1/24
UNF-5WL	White	L	Each	1/24
UNF-5WXL	White	XL	Each	1/24
UNF-5WXXL	White	2X	Each	1/24

**BLACK CHEF PANTS**

- ◆ Relaxed fit
- ◆ Elastic waistband with drawstring
- ◆ 65/35 poly-cotton blend

ITEM	COLOR	SIZE	UOM	CASE
UNF-2KS	Black	S	Each	1/24
UNF-2KM	Black	M	Each	1/24
UNF-2KL	Black	L	Each	1/24
UNF-2KXL	Black	XL	Each	1/24
UNF-2KXXL	Black	2X	Each	1/24

**HOUNDSTOOTH CHEF PANTS**

- ◆ Relaxed fit
- ◆ Elastic waistband with drawstring
- ◆ 65/35 poly-cotton blend

ITEM	COLOR	SIZE	UOM	CASE
UNF-4KS	Houndstooth	S	Each	1/24
UNF-4KM	Houndstooth	M	Each	1/24
UNF-4KL	Houndstooth	L	Each	1/24
UNF-4KXL	Houndstooth	XL	Each	1/24
UNF-4KXXL	Houndstooth	2X	Each	1/24



UNF-5KL Chef Jacket  
UNF-4KL Houndstooth Pants



UNF-5WL Chef Jacket  
UNF-2KL Black Pants

SIZING GUIDE

**SHIRTS SIZING CHART**

MEASUREMENT (INCHES)	S	M	L	XL	2XL
Chest	44	48	51	54	56
Center Back	27	28	30	32	33

**BLACK JACKET TAPERED FIT SIZING CHART**

MEASUREMENT (INCHES)	S	M	L	XL	2XL
Chest	43	47.25	50	52.5	56
Center Back	31.5	32.5	32.5	33.25	34

**WHITE JACKET UNIVERSAL FIT SIZING CHART**

MEASUREMENT (INCHES)	S	M	L	XL	2XL
Chest	44.5	49	51.25	56.5	60.75
Center Back	31	32.25	33	34	34.5

**PANTS SIZING CHART**

MEASUREMENT (INCHES)	S	M	L	XL	2XL
Waist	36	40	43	46	49
Hip	40	44	47	50	53
Inseam	29	30	31	32	33

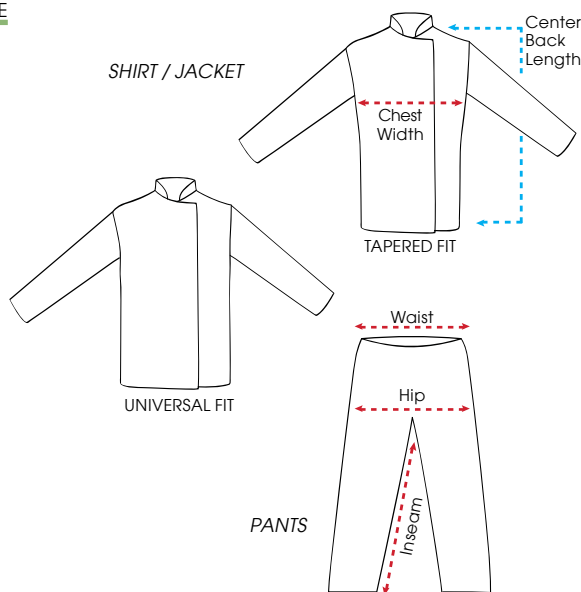



## BIB APRONS



BA-SERIES  
WITHOUT POCKETS



## FULL-LENGTH BIB APRONS

- ◆ Pen and pad pockets on select items
- ◆ Cotton-poly blend, machine wash and dry
- ◆ Wrinkle resistant
- ◆ Assorted colors available
- ◆ 33"L x 26"W

ITEM	DESCRIPTION	UOM	CASE
BA-3226BK	Black w/o Pockets	Each	12/60
BA-3226WH	White w/o Pockets	Each	12/60
BA-PBG	Burgundy w/Pockets	Each	12/60
BA-PBK	Black w/Pockets	Each	12/60
BA-PBL	Blue w/Pockets	Each	12/60
BA-PGN	Green w/Pockets	Each	12/60
BA-PLG	Light Green w/Pockets	Each	12/60
BA-PRD	Red w/Pockets	Each	12/60
BA-PWH	White w/Pockets	Each	12/60
BA-PYL	Yellow w/Pockets	Each	12/60



BA-SERIES W/ PEN & PAD POCKETS

## CHEF HATS



Adjustable  
velcro closure



CH-13LG



CH-13BG



CH-13BK



CH-13BL



CH-13GN



CH-13RD



CH-13WH



CH-13YL



## PROFESSIONAL CHEF HATS

- ◆ Cotton-poly blend, machine wash and dry
- ◆ Wrinkle resistant
- ◆ Adjustable velcro closure, one size fits most
- ◆ 13" high, band dimension adjusts from 21" to 24"
- ◆ Assorted colors available

ITEM	DESCRIPTION	UOM	CASE
CH-13BG	Burgundy	Each	24/96
CH-13BK	Black	Each	24/96
CH-13BL	Blue	Each	24/96
CH-13GN	Green	Each	24/96
CH-13LG	Light Green	Each	24/96
CH-13RD	Red	Each	24/96
CH-13WH	White	Each	24/96
CH-13YL	Yellow	Each	24/96



DCH-3

DCH-9

DCH-12

## DISPOSABLE CHEF HATS

ITEM	DESCRIPTION	SIZE	UOM	CASE
DCH-3	3" H	100 pcs/Box	Box	10
DCH-9	9" H	10 pcs/Bag	Bag	20
DCH-12	12" H	10 pcs/Bag	Bag	20

**WHITE COTTON SERVICE GLOVES**

ITEM	DESCRIPTION	UOM	CASE
GLC-M	Medium (6 pairs)	Doz	100
GLC-L	Large (6 pairs)	Doz	100

**WAIT SERVICE**



GLC-M

**BISTRO-LENGTH APRON**

◆ Cotton-poly blend, machine wash and dry, wrinkle resistant

ITEM	DESCRIPTION	UOM	CASE
WA-3129K	31"L x 29-1/2"W	Each	12/60



WA-3129K

**3-POCKET WAIST APRONS**

◆ Cotton-poly blend, machine wash and dry, wrinkle resistant

ITEM	DESCRIPTION	COLOR	UOM	CASE
WA-1221	12-1/2" x 21-3/4"	Black	Each	12/60
WA-1221G	12-1/2" x 21-3/4"	Green	Each	12/60
WA-1221R	12-1/2" x 21-3/4"	Burgundy	Each	12/60
WA-1221W	12-1/2" x 21-3/4"	White	Each	12/60

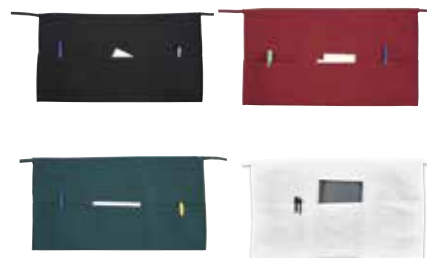

WA-SERIES

**HEAVY VINYL APRONS**

ITEM	DESCRIPTION	SIZE	UOM	CASE
BA-HN	Heavy Vinyl w/Pocket	26-1/2"W x 41-1/4"L	Each	12/24
BA-LA	Latex, Black	37"W x 44-1/2"L	Each	12

**HEAVY VINYL APRONS**



BA-LA



BA-HN

# BACK OF HOUSE

## *Clean & Organize*



### CARPET FLOOR MATS

- ◆ Vinyl backing prevents curling/ripping and stays flat for safe footing

ITEM	DESCRIPTION	COLOR	UOM	CASE
FMC-310C	3' x 10'	Charcoal	Each	1
FMC-310U	3' x 10'	Burgundy	Each	1
FMC-35C	3' x 5'	Charcoal	Each	1
FMC-35U	3' x 5'	Burgundy	Each </td <td>1</td>	1
FMC-46C	4' x 6'	Charcoal	Each	1
FMC-46U	4' x 6'	Burgundy	Each	1

### FLOOR MATS

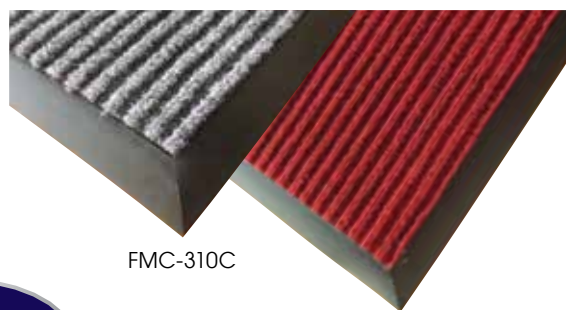

FMC-310C

FMC-310U

**TAPERED,  
WEIGHTED,  
DURABLE**

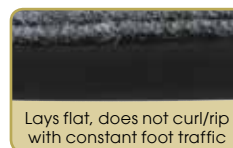

Lays flat, does not curl/rip with constant foot traffic



Tapered, weighted edge and durable

- ◆ Top-grade rubber
- ◆ Durable for long-term wear

### STRAIGHT EDGE NATURAL RUBBER FLOOR MATS

- ◆ Grease resistant

ITEM	DESCRIPTION	COLOR	UOM	CASE
RBMH-35K	3' x 5' x 3/4" Anti-Fatigue	Black	Each	1
RBMH-35R	3' x 5' x 3/4" Grease-Proof	Red	Each	1

### RUBBER FLOOR MATS

**3/4" THICK**

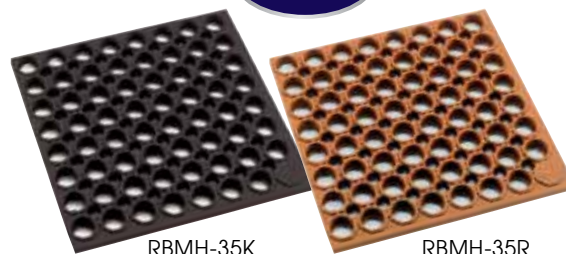

RBMH-35K

RBMH-35R

### BEVELED EDGE RUBBER FLOOR MATS

ITEM	DESCRIPTION	COLOR	UOM	CASE
RBM-35K	3' x 5' x 1/2"	Black	Each	1
RBM-35R	3' x 5' x 1/2"	Red	Each	1

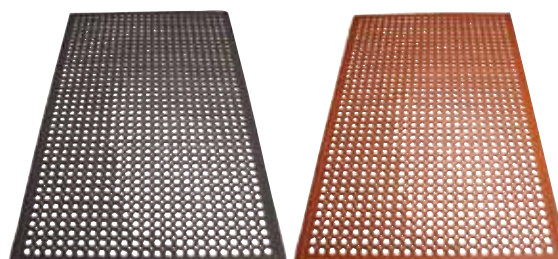

RBM-35K

RBM-35R

### PREMIUM BEVELED EDGE RUBBER FLOOR MAT

- ◆ Natural rubber

ITEM	DESCRIPTION	COLOR	UOM	CASE
RBMM-35K	3' x 5' x 3/8"	Black	Each	1

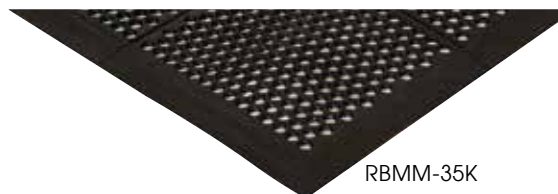

RBMM-35K

### RUBBER INTERLOCKING FLOOR MATS

ITEM	DESCRIPTION	COLOR	UOM	CASE
RBMI-33K	3' x 3' x 1/2"	Black	Each	1
RBMI-33R	3' x 3' x 1/2"	Red	Each	1

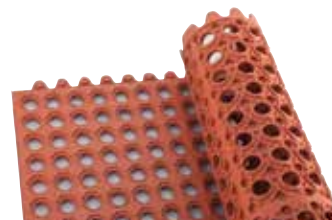

RBMI-33R



## SLENDER TRASH CANS



PTCL-23K



PTCL-23L



PTC-23GR



PTC-23L



PTC-23K



PTC-23SG



PTC-23B



PTCB-23GR



PTCB-23L



PTCP-23L

### SLENDER TRASH CANS

◆ Lids sold separately

ITEM	DESCRIPTION	COLOR	UOM	CASE
PTC-23GR	23 Gallon, Recycle	Green	Each	1
PTC-23L	23 Gallon, Recycle	Blue	Each	1
PTC-23K	23 Gallon	Black	Each	1
PTC-23SG	23 Gallon	Gray	Each	1
PTC-23B	23 Gallon	Brown	Each	1
PTCL-23	Lid for PTC-23SG	Gray	Each	4
PTCL-23B	Lid for PTC-23B	Brown	Each	4
PTCL-23K	Lid for PTC-23K	Black	Each	4
PTCL-23L	Lid for PTC-23L	Blue	Each	4

### SPECIALTY LIDS

ITEM	DESCRIPTION	COLOR	UOM	CASE
PTCB-23GR	Lid for PTC-23GR	Green	Each	1/6
PTCB-23L	Bottle/Can Recycling Cover for PTC-23L	Blue	Each	1/6
PTCP-23L	Paper Recycling Cover for PTC-23L	Blue	Each	1/6

## TRASH CAN CART



Fits standard slim trash cans



DWR-1708

### WIRE TRASH CAN CART

Move slender trash cans from one location to another with the ease of a rolling cart built for the task.

- ◆ Capacity up to 400 Lbs
- ◆ Wheels measure 3-3/4" diameter each
- ◆ Compatible with PTC-Series 23 gallon slender trash cans

ITEM	DESCRIPTION	UOM	CASE
DWR-1708	18-1/2"L x 9-1/2"W x 7"H	Each	4

Shown with PTC-23SG

### WASTE RECEPTACLE

- ◆ Features tray-top design with 9"H self-return door
- ◆ Fits up to 35 gallon capacity trash can
- ◆ Inside dimensions: 22-7/16"L x 22-7/16"W x 41-11/32"H
- ◆ Ships knocked down
- ◆ Light natural-wood color

ITEM	DESCRIPTION	UOM	CASE
WR-35	23-1/2"L x 23-3/4"W x 44"H	Each	1

### WASTE RECEPTACLE



WR-35

### HEAVY-DUTY TRASH CANS

- ◆ Lid sold separately

ITEM	DESCRIPTION	COLOR	UOM	CASE
PTC-32G	32 Gallon	Gray	Each	1
PTC-44G	44 Gallon	Gray	Each	1
FCW-10	10 Gallon, NSF	White	Each	1/6
FCW-20*	20 Gallon, NSF	White	Each	1/6
FCW-32*	32 Gallon, NSF	White	Each	1/6

\*Works with DLR-series dollies (see below section)

### HEAVY-DUTY TRASH CANS & DOLLIES



PTC-32G & PTCL-32

FCW-SERIES  
ALSO SAFE  
FOR FOOD  
STORAGE



FCW-32 & FCW-32L



FCW-32RC

### HEAVY-DUTY TRASH CAN LIDS

ITEM	DESCRIPTION	COLOR	UOM	CASE
PTCL-32	Lid for PTC-32G	Gray	Each	6
PTCL-44	Lid for PTC-44G	Gray	Each	6
FCW-10L	Lid for FCW-10, NSF	White	Each	1/24
FCW-20L	Lid for FCW-20, NSF	White	Each	1/12
FCW-32L	Lid for FCW-32, NSF	White	Each	1/12
FCW-10RC	Rotating Lid for FCW-10, NSF	White	Each	1/6
FCW-20RC	Rotating Lid for FCW-20, NSF	White	Each	1/6
FCW-32RC	Rotating Lid for FCW-32, NSF	White	Each	1/6

ITEM #	CAPACITY (GALLONS)	CAPACITY (CUPS)	FLOUR (LBS)	SUGAR (LBS)
FCW-10	10	150	47	65
FCW-20	20	300	94	130
FCW-32	32	500	156	217

### EXTRA HEAVY-DUTY DOLLY

- ◆ Holds up to 900 lbs

ITEM	DESCRIPTION	UOM	CASE
DLR-2	Extra-Heavy Dolly	Each	2
DLR-2-C	Caster for DLR-2	Each	1



DLR-2

### DOLLY

- ◆ Holds up to 400 lbs

ITEM	DESCRIPTION	UOM	CASE
DLR-18	18"Dia x 6"H, Black	Each	2
DLR-18-W	Caster for DLR-18	Each	1



DLR-18

## MOP BUCKET



MPB-36



MPB-36W



## MOP BUCKET WITH SIDE PRESS WRINGER

ITEM	DESCRIPTION	UOM	CASE
MPB-36	36 Qt, Yellow	Each	1
MPB-36W	Replacement Wringer for MPB-36	Each	2
MPB-36WH	Caster for MPB-36	Each	4

## FLOOR WARNING SIGNS



WCS-27T



WCS-25



CSF-4 & CSF-SET

## FLOOR SIGNS

ITEM	DESCRIPTION	UOM	CASE
WCS-27T	27"H, Caution Cone	Each	5
WCS-25	25" x 12", English/Spanish Floor Sign	Each	12
CSF-4	Pop-up Caution Cone	Each	12/48
CSF-SET	Set of CSF-4 and CSF-4H	Set	6/36

## SQUEEGEES



WSS-12



WS-15



FSS-24



FSC-60H

## SQUEEGEES

ITEM	DESCRIPTION	UOM	CASE
WSS-12	12" with 23" Handle	Each	6/24
WS-15	15" Window Squeegee with Telescopic Handle - Aluminum handle extends from 30" to 55"	Each	20
FSS-24	24", Straight Squeegee - Handle sold separately	Each	6
FSC-60H	55" Wooden Handle for FSS-24	Each	6

**PREMIUM YARN MOP HEADS**

- ◆ Poly-cotton blend
- ◆ 4-ply yarn
- ◆ 1-1/4" narrow band

ITEM	DESCRIPTION	SIZE	UOM	CASE
MOP-24	Blue Loop End	24oz, 600g	Each	20
MOP-32	Blue Loop End	32oz, 800g	Each	20
MOP-24C	Blue Cut End	24oz, 600g	Each	20
MOP-32C	Blue Cut End	32oz, 800g	Each	20
MOP-24W	White Loop End	24oz, 600g	Each	20
MOP-32W	White Loop End	32oz, 800g	Each	20
MOP-24WC	White Cut End	24oz, 600g	Each	20
MOP-32WC	White Cut End	32oz, 800g	Each	20

**FLOOR MOPS**



MOP-32W



MOP-24C

**MOP HANDLES**

ITEM	DESCRIPTION	SIZE	UOM	CASE
MOPH-7M	Metal, Quick-Change	57"	Each	6
MOPH-7P	Plastic, Side-Release	57"	Each	6

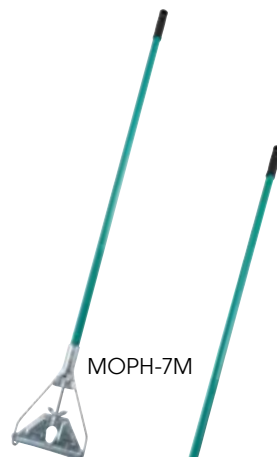

MOPH-7M



MOPH-7P

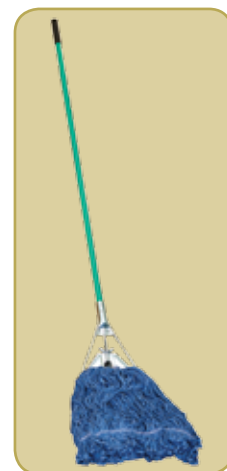

Blue mop head shown on metal broom handle

**DUST MOP**

- ◆ 60" aluminum handle
- ◆ Includes frame, mop head and handle

ITEM	DESCRIPTION	UOM	CASE
DM-24	24"W Dust Mop	Each	1/6
DM-24H	Replacement Head for DM-24, Frame not Included	Each	1/24



DM-24



FLOOR CARE



**NEW**

BRF-10R

BRF-12Y

BR-60W

FSC-60H

BRM-60L

FSW-11

DP-13C

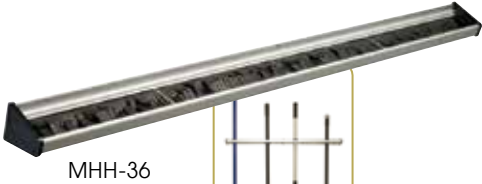

MHH-36



MHH-5



10"W FLOOR SCRUB BRUSH

ITEM	DESCRIPTION	UOM	CASE
BRF-10R	10"W	Each	1/12

12"W FLOOR SCRUB BRUSH

- ◆ Multi-angle brush; works best for cleaning around hard-to-reach places
- ◆ Angled side bristles are ideal for baseboards, under counters and around corners

ITEM	DESCRIPTION	UOM	CASE
BRF-12Y	12"W	Each	12

WOODEN HANDLES

ITEM	DESCRIPTION	UOM	CASE
BR-36W	36" O.L. fits BR-10	Each	48
BR-60W	55" O.L. fits BR-10	Each	6/24
FSC-60H	55" O.L. fits FSS-24	Each	6

LOBBY BROOM & PAN

- ◆ Built-in cover for mess-free transport

ITEM	DESCRIPTION	UOM	CASE
BRM-60L	60"L HdL	Each	12
DP-13C	13"W Pan	Set	1/10

ROTARY SWEEPER

- ◆ Non-electric rotary sweeper and dust pan with natural bristles and steel handle

ITEM	DESCRIPTION	UOM	CASE
FSW-11	11"L x 7-3/4"W x 43"H	Each	1/4

MOP & BROOM RACKS

Maximize space with these mop/broom racks that offer versatile hanging options. Outfitted with non-slip bristles, hooks and clips, they keep kitchen cleaning tools organized and within easy reach.

- ◆ MHH-36 & MHH-24 constructed of aluminum with non-slip rubber bristles that hold tools securely in place
- ◆ MHH-5 constructed of durable ABS plastic with five (5) clips and six (6) hooks

ITEM	DESCRIPTION	UOM	CASE
MHH-5	16"L, 5 Clips and 6 Hooks	Each	1/12
MHH-24	24"L Mop Rack, Rubber Bristles	Each	6/24
MHH-36	36"L Mop Rack, Rubber Bristles	Each	6/12

**HEAVY-DUTY NATURAL LATEX GLOVES**

- ◆ Soft, comfortable and durable
- ◆ Made especially for dish washers, launderers, car washers and gardeners

ITEM	DESCRIPTION	UOM	CASE
NLGH-18	10-1/2" x 18-1/2"	Pair	12/24

**NATURAL LATEX GLOVES**

ITEM	DESCRIPTION	UOM	CASE
NLG-816	Small, Yellow	Pair	12/60
NLG-916	Medium, Yellow	Pair	12/60
NLG-1018	Large, Black	Pair	12/60

**GLOVES**

- ◆ Each box contains 500 pieces
- ◆ PE textured

ITEM	DESCRIPTION	UOM	CASE
GLP-M	Medium	Box	1/10
GLP-L	Large	Box	1/10

**WHITE SERVICE GLOVES**

- ◆ 100% Cotton

ITEM	DESCRIPTION	UOM	CASE
GLC-M	Medium (6 Pairs)	Doz	100
GLC-L	Large (6 Pairs)	Doz	100

**GLOVES**



NLGH-18

NLG-816

NLG-1018



GLP-M



GLC-M

**WIPES BOX BRACKET**

ITEM	DESCRIPTION	UOM	CASE
WHW-5	4" x 5" x 8-1/4"	Each	12/24

**GLOVE BOX HOLDER**

ITEM	DESCRIPTION	UOM	CASE
WHW-10	10" x 3" x 5"	Each	12/24

**WALL BRACKETS**



WHW-5



WHW-10  
(Gloves not included)

**RETRACTABLE BOX CUTTER**

- ◆ Handy for opening boxes or slicing cardboard
- ◆ Blade retracts into metal safety sleeve

ITEM	DESCRIPTION	UOM	CASE
BXC-4	4"L	Doz	5/50
BXC-B100	Replacement Blade, 100-Pcs/Pk	Pack	5/50

**BOX CUTTER**



BXC-4



BXC-B100

## CLEANING ACCESSORIES



PPL-6G

PPL-6R



PPL-20D



BTGP-21



BTH-2028G



BTM-16AC



BTM-16W

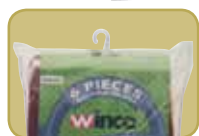

Package comes with hanging hook



BTW-30



SPG-50



PSR-9



SP-96N

### CLEANING BUCKETS

- ◆ Green pail for soap solution
- ◆ Red pail for sanitizing solution
- ◆ Not for use with food products

ITEM	DESCRIPTION	UOM	CASE
PPL-3G	3 Qt, Green	Each	12
PPL-3R	3 Qt, Red	Each	12
PPL-6G	6 Qt, Green	Each	12
PPL-6R	6 Qt, Red	Each	12

### PLASTIC DOUBLE PAIL

- ◆ Wide pour spout with compartments to separate clean wash water from rinse water

ITEM	DESCRIPTION	UOM	CASE
PPL-20D	19.55 Qt, Gray	Each	6

### GLASS POLISHING TOWEL

- ◆ 100% cotton
- ◆ Lint-free and non-abrasive to eliminate streaking, yet is gentle on glassware
- ◆ Thousands of microscopic fibers pick up dirt and dust
- ◆ Absorbs seven times its weight in liquids, also ideal for countertops and tabletops

ITEM	DESCRIPTION	UOM	CASE
BTGP-21	16" x 29", Red Pinstripes	Doz	10/20

### HERRINGBONE BAR TOWEL

- ◆ 100% cotton
- ◆ Super absorbent, ideal for wiping down tables or countertops
- ◆ Green stripe provides easy designation of towel for specific use to prevent cross-contamination

ITEM	DESCRIPTION	UOM	CASE
BTH-2028G	20" x 28"	Doz	10/20

### MICROFIBER BAR & KITCHEN TOWELS

- ◆ Lightweight, absorbent and quick drying
- ◆ BTM-16AC includes white, green, yellow, brown, orange and red
- ◆ Each pack contains six (6) pieces

ITEM	DESCRIPTION	UOM	CASE
BTM-16AC	16" x 16", Assorted Colors	Pack	1/20
BTM-16W	16" x 16", White	Pack	1/20

### WHITE BAR TOWEL

- ◆ 100% cotton

ITEM	DESCRIPTION	UOM	CASE
BTW-30	16" x 19"	Doz	10/20

### STAINLESS STEEL SPONGES

ITEM	DESCRIPTION	UOM	CASE
SPG-50	50g	Each	12/144
SPG-105	105g	Each	12/72

### SCOURING PADS

- ◆ Each pack contains six (6) pieces

ITEM	DESCRIPTION	UOM	CASE
SP-96N	6" x 9-3/8", Nylon	Pack	1/60

### PLASTIC SPRAY BOTTLE

ITEM	DESCRIPTION	UOM	CASE
PSR-9	28 Oz, 900 ml	Each	50

**HAACP COLOR-CODED CUTTING BOARD BRUSHES**

ITEM	DESCRIPTION	UOM	CASE
CBR-WT	White	Each	24/96
CBR-BN	Brown	Each	24/96
CBR-BU	Blue	Each	24/96
CBR-GR	Green	Each	24/96
CBR-RD	Red	Each	24/96
CBR-YL	Yellow	Each	24/96

**BRUSHES**



CBR-SERIES



**BEER MUG WASHER**

Eliminate hand-scrubbing glassware with Winco's Beer Mug Washer. The long-lasting nylon bristles are tough enough to get out grime, yet soft enough to not scratch or damage glass. Four suction feet hold to surfaces, preventing movement while in use.

- ◆ Features one glass washer in the center with additional scrubbing bristles on the sides
- ◆ Wide enough to accommodate a beer mug & the handle
- ◆ Dirty water can be drained through detachable hose
- ◆ Durable plastic construction at space-saving size

ITEM	DESCRIPTION	UOM	CASE
GWB-1	Beer Mug Washer	Each	1/6



GWB-1

**GLASS WASHER BRUSHES**

- ◆ Four suction feet provide stability on slippery surfaces
- ◆ Dishwasher safe

ITEM	DESCRIPTION	UOM	CASE
GWB-3	3 Brushes with Base	Each	1/12
GWB-3-BR	Brush for GWB-3	Each	1/100



GWB-3

GWB-3-BR

**COFFEE DECANTER BRUSH**

- ◆ Brush head: 1-1/4" diameter

ITEM	DESCRIPTION	UOM	CASE
CDB-11	11" O.L.	Each	12/96



CDB-11

BR-24

BR-25

BR-28

**EQUIPMENT BRUSHES**

ITEM	DESCRIPTION	UOM	CASE
BR-24	24-1/2" L-Shaped Fryer Brush	Each	12/96
BR-25	25" Urn Brush	Each	12/96
BR-28	28-1/4" Kettle Valve Brush	Each	12/96

**POT SCRUBBING BRUSHES**

- ◆ Plastic handle with nylon bristles

ITEM	DESCRIPTION	UOM	CASE
BRN-8P	8"	Each	12/72
BRN-20P	20"	Each	12/72

**ALL PURPOSE CLEAN-UP BRUSHES**

**POT BRUSHES**

- ◆ Wooden handle with coir bristles

ITEM	DESCRIPTION	UOM	CASE
BRP-10	10"	Each	12/72
BRP-20	20"	Each	6/48



BRN-8P

BRN-20P

BRP-10

BRP-20





## OVEN & BROILER BRUSHES



BR-27



BR-30



BR-31



BR-21



BR-10



BR-36W

BR-60W



BR-9



BR-12

### PIZZA OVEN SCRAPER

- ◆ Carbon wire brush and scraper

ITEM	DESCRIPTION	UOM	CASE
BR-27	Scraper with 27" Hdl	Each	12

### PIZZA OVEN/BROILER BRUSH

- ◆ Stiff stainless steel wire bristles make cleaning heavy oven residue effortless
- ◆ Quick and easy removal of heavy carbon deposits, rust and burned-on food buildup

ITEM	DESCRIPTION	UOM	CASE
BR-30	Brush w/30" Hdl	Each	8/32

### COMMERCIAL BROILER BRUSH

- ◆ 1-1/4" L steel wire bristles
- ◆ Beechwood brush base (7-11/16" L x 2-19/32" W x 1-1/64" H)
- ◆ 3/4" diameter zinc-plated iron handle

ITEM	DESCRIPTION	UOM	CASE
BR-31	31" O.L.	Each	1/12



### DUAL-HEAD BRUSH

- ◆ 1-1/2" L steel wire bristles on thick brush
- ◆ 1-1/4" L flat steel wire bristles on thin brush

ITEM	DESCRIPTION	UOM	CASE
BR-21	Dual-Headed Brush with 28" S/S Handle	Each	6

### PIZZA OVEN BRUSH HEAD

- ◆ Brass bristles with scraper

ITEM	DESCRIPTION	UOM	CASE
BR-10	Brush Head, 10-1/4" x 1-3/8" x 1-3/4"	Each	12/48
BR-36W	36" Wdn Hdl fits BR-10	Each	48
BR-60W	55" Wdn Hdl fits BR-10	Each	6/24

### BUTCHER BLOCK BRUSH

ITEM	DESCRIPTION	UOM	CASE
BR-9	Steel Bristles	Each	6/12

### OVEN & GRILL/BBQ BRUSH

ITEM	DESCRIPTION	UOM	CASE
BR-12	12" O.L., Brass Bristles	Each	12/72

### HEAVY-DUTY ALUMINUM GRILL SCRAPER

This large grill scraper with 6" wide blade features an ergonomic top-grip positioned behind the splash-guard, designed for efficient, anti-fatigue handling.

- ◆ Sharp 6" wide blade
- ◆ Dual-grip to apply added pressure to remove grease and grime from flat tops or griddles
- ◆ Splash-guard positioned above scraper blade deflects and helps collect debris for easy cleanup

ITEM	DESCRIPTION	BLADE	UOM	CASE
SCRP-14	16"L x 6"W x 4-1/2"H	5"	Each	1/12
SCRP-6B	Replacement Blade for SCR-14, 6-Pcs/Pk		Pack	1/12

### ALUMINUM GRILL SCRAPER

A great way to clean the grill quickly and safely. The handle is designed to keep hands and fingers away from the hot grill surface.

ITEM	DESCRIPTION	BLADE	UOM	CASE
SCRP-16	16" Scraper	5"	Each	1/6
SCRP-5B	Replacement Blade for SCR-16		Each	12/48

### ALUMINUM GRILL SCRAPER

Scrape away grease and stuck-on-food with ease.

ITEM	DESCRIPTION	BLADE	UOM	CASE
SCRP-12	Alu Scraper	4"	Each	12/72
SCRP-4B	Replacement Blades for SCR-12, 10-Pcs/Pk		Pack	10/100

### GRIDDLE CLEANERS

ITEM	DESCRIPTION	UOM	CASE
GSH-1	Griddle Screen Holder, 5" x 2-3/4"	Each	12/48
GSN-4	Grill Screen, Fits with GSH-1; 4" x 5-1/2", 20 pcs/pk;	Pack	20/80
GBH-2	Griddle Brick Holder, 7" x 3-1/2"	Each	6/72
GBK-348	Grill Brick, Fits with GBH-2; 3-1/2" x 4" x 8";	Doz	1

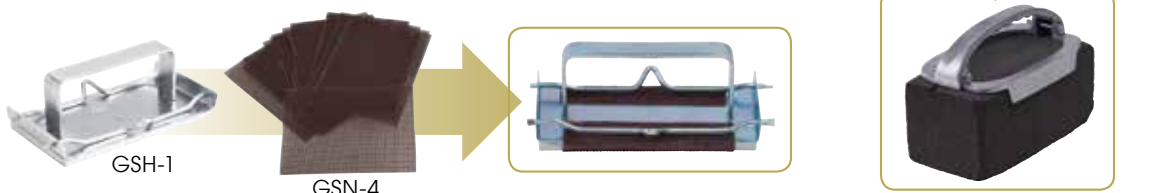

### GRILL MAINTENANCE



### MINI UTILITY BRUSHES

- ◆ Ideal for cleaning ceramic tiles and narrow spaces

ITEM	DESCRIPTION	UOM	CASE
BR-7B	7" O.L., Brass Bristles	Each	48/576
BR-7S	7" O.L., S/S Wire Bristles	Each	48/576

### SCRATCH BRUSHES



### SCRATCH BRUSHES

ITEM	DESCRIPTION	UOM	CASE
BR-319	14" O.L., Steel Bristles	Doz	1/12
BR-500	20" O.L., Wire Bristles	Each	6/48

## RESTROOM NECESSITIES



TD-600



TD-700



### PAPER TOWEL CABINETS

- ◆ Dispenses 400 C-Fold or 525 M-fold towels (3-1/8" to 3-13/16") without adjustments or adapters

ITEM	DESCRIPTION	UOM	CASE
TD-600	White Epoxy-Coated Iron	Each	1/6
TD-700	Stainless Steel	Each	1/6



TD-300

### M-FOLD PAPER TOWEL DISPENSER

- ◆ Dispenser accommodates paper pack size of 8-1/2" x 3-1/8" x 6" (maximum of 200 pieces) with an approximate weight of 0.88 lbs

ITEM	DESCRIPTION	UOM	CASE
TD-300	Fits M/C-Fold	Each	1/10



TD-330

### PAPER TOWEL DISPENSER

- ◆ Dispenser accommodates a paper roll size of 7-7/8" Dia x 7-7/8"L with an approximate weight of 3.19 lbs

ITEM	DESCRIPTION	UOM	CASE
TD-330	Center-Pull	Each	1/6



TD-500

### PAPER TOWEL DISPENSER, LEVER HANDLE

- ◆ Dispenser accommodates a paper roll size of 7-1/2" Dia x 7-7/8"L with an approximate weight of 3.30 lbs

ITEM	DESCRIPTION	UOM	CASE
TD-500	Fits 7-1/2" Dia Paper Roll	Each	1/3



AFD-1



### AUTOMATIC AIR FRESHENER

- ◆ Fully programmable dispenser
- ◆ Spray intervals are 5, 10, 15 or 30 minutes
- ◆ Working time setting options are day, night or 24 hours
- ◆ Accommodates standard size 6.6 oz refill sprays (not included)

ITEM	DESCRIPTION	UOM	CASE
AFD-1	Automatic Intervals	Each	6/24



SD-100

### MANUAL SOAP DISPENSER

ITEM	DESCRIPTION	UOM	CASE
SD-100	1 Liter, Wall Mount	Each	1/24

## RESTROOM NECESSITIES

### TWIN ROLLS TOILET TISSUE DISPENSER

- ◆ Dispenser accommodates two tissue paper rolls, each with an approximate size of 9-1/2" Dia x 4"H and each with an approximate weight of 1.71 lbs

ITEM	DESCRIPTION	UOM	CASE
TD-220	Twin Rolls	Each	1/3



TD-220

### JUMBO ROLL PAPER DISPENSERS

- ◆ Dispenser accommodates a tissue paper roll with an approximate weight of 4.18 lbs

ITEM	DESCRIPTION	UOM	CASE
TD-120	14"Dia	Each	1/3
TD-120S	11"Dia	Each	1/6



TD-120S



TTH-1



TTH-2



### TOILET TISSUE HOLDERS

- ◆ Chrome-plated steel

ITEM	DESCRIPTION	UOM	CASE
TTH-1	Single Roll	Each	1/36
TTH-2	Double Roll	Each	1/24

### TOILET SEAT COVERS

ITEM	DESCRIPTION	UOM	CASE
TSC-10	Half-Fold Dispenser	Each	20
TSC-250	Half-Fold Covers, 250-Pcs/Bag	Bag	1/20



TSC-10



TSC-250

### RUBBER PLUNGER WITH WOODEN HANDLE

ITEM	DESCRIPTION	UOM	CASE
TP-300	19" O.L.	Each	1/48



TP-300

### TOILET BRUSH WITH PLASTIC HANDLE

ITEM	DESCRIPTION	UOM	CASE
BR-15	12" O.L.	Each	12/48



BR-15

### URINAL SCREEN WITH DEODORIZER BLOCK

ITEM	DESCRIPTION	UOM	CASE
USF-4	Screen & Deodorizer	Each	12/144

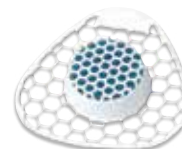

USF-4





## HOOD FILTERS



HFS-1620



HFS-1625

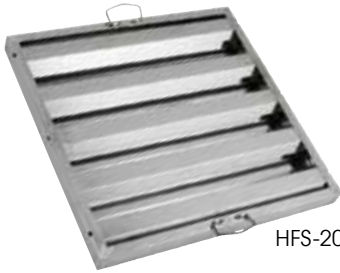

HFS-2020



HFS-2025



HFS-2520

## STAINLESS STEEL HOOD FILTERS

Essential to any kitchen, these hood filters are durable and long-lasting, helping to prevent unsafe working conditions.

- ◆ Easily clean with degreaser, soap and water, or in the dishwasher

ITEM	DESCRIPTION	UOM	CASE
HFS-1620	16"W x 20"H	Each	1/6
HFS-1625	16"W x 25"H	Each	1/6
HFS-2016	20"W x 16"H	Each	1/6
HFS-2020	20"W x 20"H	Each	1/6
HFS-2025	20"W x 25"H	Each	1/6
◆ HFS-2520	25"W x 20"H	Each	1/6

## JANITORIAL ACCESSORIES

### PAIL OPENER

- ◆ Aluminum

ITEM	DESCRIPTION	UOM	CASE
POA-8	8-7/16"L x 2-3/4"W x 1-7/16"D	Each	6/72

### OVERFLOW PIPES

ITEM	DESCRIPTION	UOM	CASE
OP-7	7"L x 1"Dia	Each	24/288
OP-11	11"L x 1"Dia	Each	12/144

### SINK STRAINER

- ◆ Stainless steel

ITEM	DESCRIPTION	UOM	CASE
SIK-3	3"Dia w/Stopper	Each	24/144

### RUBBER SCRAP BLOCK

ITEM	DESCRIPTION	UOM	CASE
RSB-6	6-1/2"Dia x 4"H	Each	12

### PLASTIC FUNNELS

ITEM	DESCRIPTION	UOM	CASE
PF-8	4"Dia	Each	6/324
PF-16	5-1/4"Dia	Each	6/324
PF-32	6-1/4"Dia	Each	6/216

### WIDE MOUTH FUNNELS & REMOVABLE STRAINERS

- ◆ Stainless steel mirror finish for SF-5 and SF-6

ITEM	DESCRIPTION	UOM	CASE
SF-5	5"Dia	Each	12/72
SF-6	5-3/4"Dia	Each	12/72
SF-6S	Strainer for SF-6	Each	120/480



POA-8



OP-7



SIK-3



PF-32



RSB-6



SF-6



SF-6S

- ◆ Shelving set includes four (4) shelves and four (4) 72" high posts
- ◆ Heavy-duty wire construction
- ◆ Bright chrome-plated / epoxy-coated finish to reduce dust and dirt accumulation
- ◆ Easy to assemble, no tools required
- ◆ Withstands temperatures from -100°F to 500°F
- ◆ Capacities: under 48" in length, up to 850 lbs per shelf; over 48" in length, up to 600 lbs per shelf

## WIRE SHELVING SETS

### CHROME-PLATED WIRE SHELVING SET

- ◆ NSF listed for use in dry storage and heated environments

ITEM	DESCRIPTION	UOM	CASE
VCS-1836	18"W x 36"L	Set	1
VCS-1848	18"W x 48"L	Set	1
VCS-2436	24"W x 36"L	Set	1
VCS-2448	24"W x 48"L	Set	1



VCS-SERIES NSF

### EPOXY COATED WIRE SHELVING SET

- ◆ NSF listed for use in all environments, including humid areas

ITEM	DESCRIPTION	UOM	CASE
VEXS-1836	18"W x 36"L	Set	1
VEXS-1848	18"W x 48"L	Set	1
VEXS-2436	24"W x 36"L	Set	1
VEXS-2448	24"W x 48"L	Set	1



VEXS-SERIES NSF

### 3-TIER WIRE SHELVING CARTS

Winco's sturdy shelving now comes in a full cart set! Unlike traditional carts that have fixed heights, these wire shelving carts are height-adjustable to fit your storage needs.

- ◆ Includes three (3) adjustable-height shelves
- ◆ Capacity up to 800 Lbs
- ◆ Step-lock feature on two casters
- ◆ Ships knocked down

ITEM	DESCRIPTION	UOM	CASE
VCCD-1836B	18"W x 36"L	Set	1
VCCD-2448B	24"W x 48"L	Set	1



VCCD-1836B

VCCD-SERIES

### MOBILE SHELVING EXTENSION HANDLE

- ◆ Use extension handles on mobile units for easy transport
- ◆ Includes two (2) sleeve clips per handle

ITEM	DESCRIPTION	UOM	CASE
VCH-14	14"W	Each	12
VCH-18	18"W	Each	12
VCH-21	21"W	Each	12
VCH-24	24"W	Each	12



VCH-24

## WIRE SHELVES

- ◆ NSF listed for use in dry storage and heated environments
- ◆ Heavy-duty wire construction
- ◆ Bright chrome-plated finish reduces dust and dirt accumulation
- ◆ Mix-and-match the various sizes to suit any need
- ◆ Easy to assemble, no tools required
- ◆ Capacities: under 48" in length, up to 850 lbs per shelf; over 48" in length, up to 600 lbs per shelf
- ◆ Includes four (4) sleeve clips per shelf



**NSF** VC-SERIES SHELVES



Customize the Chrome-Plated Wire Shelves to accommodate all of your storage needs



**NSF** VC-SERIES POSTS



VCB-SERIES WALL MOUNT BRACKET



VC-HK



## CHROME-PLATED WIRE SHELVES

- ◆ Withstands temperatures from -100°F to 500°F
- ◆ Must purchase in multiples of two (2)
- ◆ NSF listed

ITEM	DESCRIPTION (WxL)	UOM	CASE
VC-1424	14" x 24"	Each	2
VC-1430	14" x 30"	Each	2
VC-1436	14" x 36"	Each	2
VC-1448	14" x 48"	Each	2
VC-1460	14" x 60"	Each	2
VC-1472	14" x 72"	Each	2
VC-1824	18" x 24"	Each	2
VC-1830	18" x 30"	Each	2
VC-1836	18" x 36"	Each	2
VC-1842	18" x 42"	Each	2
VC-1848	18" x 48"	Each	2
VC-1854	18" x 54"	Each	2
VC-1860	18" x 60"	Each	2
VC-1872	18" x 72"	Each	2
VC-2124	21" x 24"	Each	2
VC-2130	21" x 30"	Each	2
VC-2136	21" x 36"	Each	2
VC-2148	21" x 48"	Each	2
VC-2160	21" x 60"	Each	2
VC-2172	21" x 72"	Each	2
VC-2424	24" x 24"	Each	2
VC-2430	24" x 30"	Each	2
VC-2436	24" x 36"	Each	2
VC-2442	24" x 42"	Each	2
VC-2448	24" x 48"	Each	2
VC-2454	24" x 54"	Each	2
VC-2460	24" x 60"	Each	2
VC-2472	24" x 72"	Each	2



## CHROME-PLATED POSTS

- ◆ For wire shelving
- ◆ Must purchase in multiples of four (4)
- ◆ Withstands temperatures from -100°F to 500°F
- ◆ NSF listed

ITEM	DESCRIPTION	UOM	CASE
VC-8P	8"H	Each	4
VC-34P	34"H	Each	4
VC-48P	48"H	Each	4
VC-54P	54"H	Each	4
VC-63P	63"H	Each	4
VC-72P	72"H	Each	4
VC-86P	86"H	Each	4

## CHROME-PLATED WALL MOUNT BRACKETS

- ◆ Brackets for mounting single wire shelving
- ◆ Each pack contains two (2) pieces

ITEM	DESCRIPTION	UOM	CASE
VCB-14	14"W	Pair	2
VCB-18	18"W	Pair	2
VCB-21	21"W	Pair	2
VCB-24	24"W	Pair	2

## S/N-STYLE HOOK FOR CHROME-PLATED SHELVING

- ◆ Holds shelves together when standing next to each other

ITEM	DESCRIPTION	UOM	CASE
VC-HK	S/N Hook for VC-series Shelves	Each	20/200

### EPOXY-COATED WIRE SHELVES

- ◆ Withstands temperatures from -100°F to 500°F
- ◆ Must purchase in multiples of two (2)
- ◆ NSF listed

ITEM	DESCRIPTION (WxL)	UOM	CASE
VEX-1424	14" x 24"	Each	2
VEX-1430	14" x 30"	Each	2
VEX-1436	14" x 36"	Each	2
VEX-1448	14" x 48"	Each	2
VEX-1460	14" x 60"	Each	2
VEX-1472	14" x 72"	Each	2
VEX-1824	18" x 24"	Each	2
VEX-1830	18" x 30"	Each	2
VEX-1836	18" x 36"	Each	2
VEX-1842	18" x 42"	Each	2
VEX-1848	18" x 48"	Each	2
VEX-1854	18" x 54"	Each	2
VEX-1860	18" x 60"	Each	2
VEX-1872	18" x 72"	Each	2
VEX-2124	21" x 24"	Each	2
VEX-2130	21" x 30"	Each	2
VEX-2136	21" x 36"	Each	2
VEX-2148	21" x 48"	Each	2
VEX-2160	21" x 60"	Each	2
VEX-2172	21" x 72"	Each	2
VEX-2424	24" x 24"	Each	2
VEX-2430	24" x 30"	Each	2
VEX-2436	24" x 36"	Each	2
VEX-2442	24" x 42"	Each	2
VEX-2448	24" x 48"	Each	2
VEX-2454	24" x 54"	Each	2
VEX-2460	24" x 60"	Each	2
VEX-2472	24" x 72"	Each	2



### EPOXY-COATED POSTS

- ◆ For wire shelving
- ◆ Must purchase in multiples of four (4)
- ◆ Withstands temperatures from -100°F to 500°F
- ◆ NSF listed

ITEM	DESCRIPTION	UOM	CASE
VEX-8P	8"H	Each	4
VEX-34P	34"H	Each	4
VEX-48P	48"H	Each	4
VEX-54P	54"H	Each	4
VEX-63P	63"H	Each	4
VEX-72P	72"H	Each	4
VEX-86P	86"H	Each	4

### EPOXY-COATED WALL MOUNT BRACKETS

- ◆ Brackets for mounting single wire shelving
- ◆ Each pack contains two (2) pieces

ITEM	DESCRIPTION	UOM	CASE
VEXB-14	14"W	Pair	2
VEXB-18	18"W	Pair	2
VEXB-21	21"W	Pair	2
VEXB-24	24"W	Pair	2

### S/N-STYLE HOOK FOR EPOXY-COATED SHELVING

- ◆ Holds shelves together when standing next to each other

ITEM	DESCRIPTION	UOM	CASE
VEX-HK	S/N Hook for VEX-series Shelves	Each	20/200

## WIRE SHELVES

- ◆ NSF listed for use in all environments, including humid areas
- ◆ Heavy-duty wire construction
- ◆ Bright epoxy-coated finish reduces dust and dirt accumulation
- ◆ Mix-and-match the various sizes to suit any need
- ◆ Easy to assemble, no tools required
- ◆ Capacities: under 48" in length, up to 850 lbs per shelf; over 48" in length, up to 600 lbs per shelf
- ◆ Includes four (4) sleeve clips per shelf



VEX-SERIES SHELVES NSF



Customize the Epoxy Coated Wire Shelves to accommodate all of your storage needs



VEX-SERIES POSTS NSF

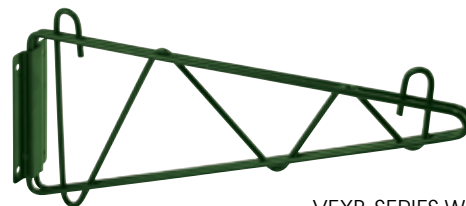

VEXB-SERIES WALL MOUNT BRACKET



VEX-HK



## SHELVING MATS



VM-SERIES

### SHELVING MATS

- ◆ Creates a solid surface for wire shelves to prevent small debris and leaks from falling through
- ◆ Protects epoxy coated shelves from scratches
- ◆ 0.75mm thick polypropylene
- ◆ 4-Pcs/Pk

ITEM	DESCRIPTION (WxL)	UOM	CASE
VM-1448	14" x 48"	Pack	4
VM-1460	14" x 60"	Pack	4
VM-1824	18" x 24"	Pack	4
VM-2424	24" x 24"	Pack	4
VM-2448	24" x 48"	Pack	4
VM-2460	24" x 60"	Pack	4

## SHELVING PARTS & ACCESSORIES



VC-LF



VC-SC2



VC-FP



VC-CT



VC-CTB

### PARTS FOR WIRE SHELVING

- ◆ Secure shelving to floors
- ◆ Each pack contains four (4) pieces

ITEM	DESCRIPTION	UOM	CASE
VC-LF	Shelf Leveling Foot	Pack	1/100
VC-SC2	Shelf Sleeve Clips	Pack	1/150

### SHELVING FOOT PLATE

- ◆ Secure shelving to floors
- ◆ Each pack contains four (4) pieces

ITEM	DESCRIPTION	UOM	CASE
VC-FP	Foot Plate w/Screws	Pack	1/100

### CASTERS FOR WIRE SHELVING

- ◆ 5" diameter

ITEM	DESCRIPTION	UOM	CASE
VC-CT	Caster	Each	4/24
VC-CTB	Casters with Brake	Each	4/24

## DUNNAGE RACKS



ASDR-1424

**NSF** ASDR-SERIES





ADRK-2036

**NSF** ADRK-SERIES

### ALUMINUM DUNNAGE RACKS

- ◆ Great for storing items off the floor in any environment
- ◆ NSF listed

ITEM	DESCRIPTION	SIZE (L X W X H)	UOM	CASE
ASDR-1424	Holds up to 1200 Lbs	24" x 14" x 8"	Each	8
ASDR-2036	Holds up to 1800 Lbs	36" x 20" x 8"	Each	6
ASDR-2048	Holds up to 1500 Lbs	48" x 20" x 8"	Each	6
 ASDR-2060	Holds up to 1200 Lbs	60" x 20" x 8"	Each	6
ADRK-2036	Holds up to 1800 Lbs	36" x 20" x 12"	Each	6
 ADRK-2048	Holds up to 1500 Lbs	48" x 20" x 12"	Each	6
 ADRK-2060	Holds up to 1200 Lbs	60" x 20" x 12"	Each	6

### FLATWARE CYLINDERS & HOLDERS

ITEM	DESCRIPTION	UOM	CASE
FC-PL	Perforated, Plastic	Each	36/144
FC-SS	Perforated, S/S	Each	20/80
FC-SL	Solid, S/S	Each	20/80
FC-4H	4-Holes/2-Tier Holder, S/S	Each	1/4
FC-6H	6-Holes/2-Tier Holder, S/S	Each	1/2

### CUTLERY ORGANIZERS

ITEM	DESCRIPTION	UOM	CASE
OGZ-6	Organizer Bin Set	Set	1
OGZ-1B	Bin for OGZ-6	Each	6

### CUTLERY COMPARTMENT BINS

ITEM	DESCRIPTION	UOM	CASE
PL-4B	Plastic	Each	1/12
SCB-4	Stainless Steel	Each	1/8

### CUTLERY DISHWASHER BASKET

- ◆ Eight (8) compartments, molded-in handles
- ◆ NSF listed

ITEM	DESCRIPTION	UOM	CASE
PCB-8	17" x 8" x 6"	Each	12



PL-4B



SCB-4



PCB-8



### FLATWARE ORGANIZERS



FC-4H



FC-PL



FC-SS



FC-SL



OGZ-6

### DISH CADDY

- ◆ Rounded corner design made of polyethylene helps prevent impact damage to surrounding furnishings while caddy is in transit
- ◆ 6 adjustable divider posts allow caddy to hold trays, plates and a wide array of dish sizes
- ◆ Each column holds 45-60 plates with a diameter of 4-1/2" to 13"
- ◆ Sure-grip handle for easy and safe transporting
- ◆ Includes cover

ITEM	DESCRIPTION	UOM	CASE
DCA-6	36-1/2"L x 58-1/2"W x 31-1/2"H	Set	1
DCA-C10	10" Caster for DCA-6	Each	1
DCA-C5B	5" Brake Caster for DCA-6	Each	1



4 columns 4-1/2" plates  
2 columns 5-1/2" - 7" plates  
2 columns 7" - 9" plates



4 columns 9"-13" plates



6 columns 7" - 9" plates



6 columns 5-1/2" - 7" plates



5 columns 5" plates  
2 columns 9"-13" plates



5 columns 4-1/2" plates  
3 columns 7" - 9" plates

### DISH CADDY



DCA-6



Includes vinyl cover

# ALUMINUM SHEET PAN & BUN RACKS



Winco's exclusive Weld<sup>2</sup> System features fail-safe rigidity through both bolting and welding at all critical joints to prevent warping with long term, high-traffic use

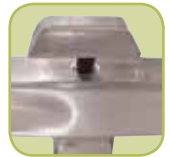

Specialty bolts secure each joint



Bolt caps are welded over completely to form extra-strength juncture

**NSF** AWRK-20  
\*10 Tier Available

Made for the most demanding restaurant kitchens, these aluminum sheet pan racks accommodate standard full-size 18" x 26" sheet/bun pans, or twice the capacity with half-size 18" x 13" pans. All racks are shipped knocked down and require assembly except for the welded series.

## WELDED SHEET PAN RACKS

- ◆ Featuring Winco's exclusive Weld<sup>2</sup> Dual Weldment System
- ◆ Heavy-duty caster wheels handle loads up to 650 lbs
- ◆ NSF listed

ITEM	DESCRIPTION	UOM	CASE
AWRK-10	10-Tier, 3" Spacing	Each	1
AWRK-20	20-Tier, 3" Spacing	Each	1

## SHEET PAN RACKS WITH BRAKES

- ◆ Ships knocked down
- ◆ NSF listed

ITEM	DESCRIPTION	UOM	CASE
ALRK-10BK	10-Tier, 3" Spacing	Each	1
ALRK-20BK	20-Tier, 3" Spacing	Each	1
ALRK-30BK	30-Tier, 2" Spacing (with heavyweight casters)	Set	1

## SHEET PAN RACKS

- ◆ Ships knocked down
- ◆ NSF listed

ITEM	DESCRIPTION	UOM	CASE
ALRK-10	10-Tier w/o Brake	Each	1
ALRK-20	20-Tier w/o Brake	Each	1

## SHEET PAN RACK ACCESSORIES

ITEM	DESCRIPTION	UOM	CASE
ALRK-10-CV	Cover for 10-Tier Rack	Each	1/12
ALRK-20-CV	Cover for 20- and 30-Tier Racks	Each	1/12
ALRC-5ST	Caster for ALRK and AWRK-series	Each	12
ALRC-5STK	Caster w/Brake for ALRK & AWRK-series	Each	12
ALRC-5H	Caster for ALRK-30BK, Heavyweight	Each	12
ALRC-5HK	Caster w/Brake for ALRK-30BK, Heavyweight	Each	12

## REPLACEMENT CASTERS FOR SHEET PAN RACKS

ITEM	ALRK-3	ALRK-15	ALRK-10	ALRK-20	ALRK-10BK	ALRK-20BK	ALRK-30BK	AWRK-10	AWRK-20
ALRC-5P	4								
ALRC-5ST		2	4	4	2	2		4	2
ALRC-5STK		2			2	2			2
ALRC-5H							2		
ALRC-5HK							2		



**NSF** ALRK-10BK   **NSF** ALRK-20BK   **NSF** ALRK-30BK



**NSF** ALRK-10   **NSF** ALRK-20   ALRK-10-CV   ALRK-20-CV



ALRC-5STK  
5" caster with brake

### 20-TIER NESTING RACK WITH BRAKES

Designed with space-saving in mind, the Z-rack fits snugly with nesting racks to conserve floor space while in storage. The Z-rack accommodates standard full-size sheet pans, or twice the capacity with half-size pans.

- ◆ Z-frame nesting design for compact storage
- ◆ Sturdy aluminum structure
- ◆ Capacity: up to 650 lbs & 20 full-size (18" x 26") sheet pans
- ◆ Full-swivel casters; two (2) with brake
- ◆ 3" spacing between each tier
- ◆ Fully assembled: 22" L x 27-1/2"W x 70"H
- ◆ NSF listed

ITEM	DESCRIPTION	SIZE	UOM	CASE
ALZK-20BK	20-Tier, Knocked Down	22"L x 27-1/2"W x 70"H	Each	1
AWZK-20	20-Tier, Welded	22"L x 27-1/2"W x 70"H	Each	1



ALRC-5STK  
5" caster  
with brake

### ALUMINUM SHEET PAN & BUN RACKS



ALZK-20BK



AVAILABLE  
EITHER  
KNOCKED DOWN  
OR WELDED

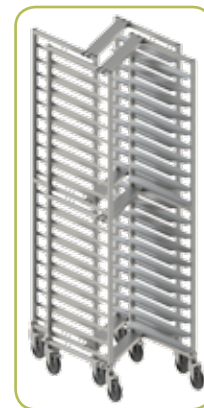

ALZK-20BK  
AWZK-20 NSF

### COUNTER-HEIGHT SHEET PAN RACK

- ◆ Rack has slides and a hard top that can be used as cutting board stand
- ◆ 14 gauge 6063 aluminum with 1" extruded tube frame
- ◆ Full swivel casters, 5" diameter x 1-1/4"
- ◆ Capacity fits 15 full-size (18" x 26") or 30 half-size (18" x 13") sheet pans (not included)
- ◆ Capacity up to 200 lbs
- ◆ Ships knocked down
- ◆ NSF listed

ITEM	DESCRIPTION	SIZE	UOM	CASE
ALRK-15	15-Tier	26-1/8"L x 20-7/8"W x 31-5/8"H	Set	1



ALRK-15 NSF

### SHEET PAN TRUCK

- ◆ 14 gauge 6063 aluminum with 1" extruded aluminum tube frame
- ◆ Full swivel casters, 5" diameter x 1-1/4" width
- ◆ Capacity is 54 full-size (18" x 26") or 108 half-size (13" x 18") sheet pans (not included)
- ◆ Ships knocked down
- ◆ NSF listed

ITEM	DESCRIPTION	SIZE	UOM	CASE
ALRK-3	Sheet Pan Truck	28-7/8"L x 20-5/8"W x 33-3/8"H	Set	1
ALRC-5P	Replacement Caster for ALRK-3		Each	12



ALRK-3

ALRK-SERIES NSF



## WIRE DOLLY



Transport dough boxes

SEE PAGE 214 FOR DOUGH BOXES



DWR-2617

## WIRE DOUGH BOX DOLLY

Transport multiple dough boxes with ease using this wire dolly, currently the only one on the market!

- ◆ Capacity up to 400 lbs
- ◆ Winco® exclusive
- ◆ Wheels measure 3-3/4" Dia each

ITEM	DESCRIPTION	UOM	CASE
DWR-2617	27"L x 18-1/4"W x 2-1/2"H	Each	1

## UNIVERSAL CASTERS



CT-1



CT-1B



CT-44



CT-44B



CT-23



CT-23B



CT-33



CT-33B

## UNIVERSAL CASTERS, EXTRA HEAVY-DUTY

- ◆ Great for use with most appliances including ranges or walk-in refrigerators
- ◆ Polyurethane, skid-free - will not mark floors
- ◆ High-quality grease-resistant wheel
- ◆ Temperature range from 14°F to 212°F
- ◆ 5" diameter wheels (will raise height of equipment by 6")
- ◆ Wheel capacity: 220 lbs each
- ◆ CT-1 and CT-1B fit standard 1-5/8" or 1-1/2" tubing
- ◆ Shipped in packs of two (2) pieces per set

ITEM	DESCRIPTION	PLATE SIZE	UOM	CASE
CT-1	Worktable Stem Caster Set		Set	1/12
CT-1B	Worktable Stem Caster Set With Brake		Set	1/12
CT-23	Universal Plate Caster Set	2-3/8" x 3-5/8"	Set	1/12
CT-23B	Universal Plate Caster Set With Brake	2-3/8" x 3-5/8"	Set	1/12
CT-33	Universal Plate Caster Set	3-1/2" x 3-1/2"	Set	1/12
CT-33B	Universal Plate Caster Set With Brake	3-1/2" x 3-1/2"	Set	1/12
CT-44	Universal Plate Caster Set	4" x 4"	Set	1/12
CT-44B	Universal Plate Caster Set With Brake	4" x 4"	Set	1/12

### GRAY POLYPROPYLENE LUG BOX

- ◆ Containers can nest together, stack across each other and stack with lids on
- ◆ BPA-free

ITEM	DESCRIPTION	UOM	CASE
PL-8	24" x 15" x 8"	Each	1
PL-8C	Cover	Each	12

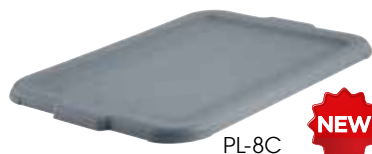

PL-8C



PL-8



Conveniently nest together



Stackable



PL-SERIES

### HEAVYWEIGHT POLYPROPYLENE DISH BOXES

- ◆ Larger, thicker and stronger than standard dish boxes
- ◆ Freezer safe
- ◆ BPA-free
- ◆ NSF listed

ITEM	DESCRIPTION	COLOR	UOM	CASE
PLW-7G	21" x 17" x 7"	Gray	Each	1
PLW-7K	21" x 17" x 7"	Black	Each	1
PLW-7W	21" x 17" x 7"	White	Each	1
PLW-CG	Cover	Gray	Each	12
PLW-CK	Cover	Black	Each	12
PLW-CW	Cover	White	Each	12



PLW-7W



PLW-7K



PLW-7G



PL-SERIES

### HEAVYWEIGHT POLYPROPYLENE PERFORATED BUS BOXES

- ◆ Drains easily to eliminate excess water
- ◆ Ideal for thawing food
- ◆ BPA-free

ITEM	DESCRIPTION	COLOR	UOM	CASE
PLP-5G	21-1/4" x 15-3/8" x 4-7/8"	Gray	Each	1
PLP-5W	21-1/4" x 15-3/8" x 4-7/8"	White	Each	1



PLP-5W



Perforated Bottom



PLP-SERIES

### STANDARD POLYPROPYLENE DISH BOXES

- ◆ BPA-free
- ◆ NSF listed

ITEM	DESCRIPTION	COLOR	UOM	CASE
PL-5G	20-1/4" x 15-1/2" x 5"	Gray	Each	1
PL-5K	20-1/4" x 15-1/2" x 5"	Black	Each	1
PL-5W	20-1/4" x 15-1/2" x 5"	White	Each	1
PL-7G	21-1/2" x 15" x 7"	Gray	Each	1
PL-7B	21-1/2" x 15" x 7"	Brown	Each	1
PL-7K	21-1/2" x 15" x 7"	Black	Each	1
PL-7W	21-1/2" x 15" x 7"	White	Each	1
PL-57C	Cover	Gray	Each	1/12
PL-57B	Cover	Brown	Each	1/12
PL-57K	Cover	Black	Each	1/12
PL-57W	Cover	White	Each	1/12



PL-SERIES

### HEAVYWEIGHT POLYPROPYLENE DIVIDED BUS BOXES

- ◆ Two (2) compartments
- ◆ Economical storage for heavy loads
- ◆ Rounded corners for easy cleaning
- ◆ BPA-free

ITEM	DESCRIPTION	COLOR	UOM	CASE
PLTC-7G	21" x 16-3/4" x 6-1/2"	Gray	Each	1
PLTC-7K	21" x 16-3/4" x 6-1/2"	Black	Each	1



PLTC-7K



PLTC-SERIES

### WHITE MINI BIN

- ◆ Polypropylene
- ◆ BPA-free

ITEM	DESCRIPTION	UOM	CASE
PL-MB	14-3/4" x 12-1/2" x 5-3/8"	Each	24
PL-MBC	Cover	Each	24

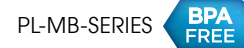

PL-MB-SERIES



## UTILITY & BUS CARTS



UC-2415G



UC-2415G shown with accessory bins



UC-SB



UC-RB



UC-3019K



SUC-30

### UTILITY CARTS

- ◆ 3-tier cart
- ◆ Polypropylene
- ◆ UC-2415 series weighs 17.5 lbs
- ◆ UC-3019 series weighs 27 lbs
- ◆ Accessory bins sold separately
- ◆ Ships knocked down



ITEM	DESCRIPTION	CAPACITY	COLOR	UOM	CASE
UC-2415G	32"L x 16-1/8"W x 36-3/4"H	330 Lbs	Gray	Set	1
UC-2415K	32"L x 16-1/8"W x 36-3/4"H	330 Lbs	Black	Set	1
UC-3019G	40-3/4"L x 19-1/2"W x 37-3/8"H	400 Lbs	Gray	Set	1
UC-3019K	40-3/4"L x 19-1/2"W x 37-3/8"H	400 Lbs	Black	Set	1
UC-RB	Refuse Bin			Each	3
UC-SB	Silverware Bin			Each	6
UC-WH	Casters			Each	1/30

Replace former UC-35 Series, UC-40 Series, UC-B Series

### STAINLESS STEEL TROLLEY

- ◆ 3-tier cart
- ◆ Ships knocked down

ITEM	DESCRIPTION	UOM	CASE
SUC-30	30" x 16" x 33" 30" x 16" x 27" (w/o Wheels)	Set	1
SUC-30-C	Caster for SUC-30	Each	4/12
SUC-30-CB	Brake Caster for SUC-30	Each	4/12

## BOX CARTS



**NSF** ABBC-6



**NSF** ALBC-1



### ALUMINUM BUS BOX CART

- ◆ 14 gauge aluminum with a 1" extruded aluminum tube frame
- ◆ 5" Dia x 1-1/4" W, full swivel casters
- ◆ Ships knocked down
- ◆ Capacity: 6 or more (stacked) bus or lug boxes

ITEM	DESCRIPTION	UOM	CASE
ABBC-6	18-5/8" x 26" x 70-1/4"	Set	1
ALRC-5ST	Caster for ABBC-6	Each	12

Compatible WINCO® accessories:  
PL-5G, -5K, -5W, -7G, -7K, -7W bus boxes

### ALUMINUM LUG BOX CART

- ◆ 14 gauge aluminum with a 1" extruded aluminum tube frame
- ◆ 5" Dia x 1-1/4" W, full swivel casters
- ◆ Ships knocked down
- ◆ Compatible with single or stacked lug boxes

ITEM	DESCRIPTION	UOM	CASE
ALBC-1	16-3/4" x 25-1/16" x 19"	Set	1
ALRC-5ST	Caster for ALBC-1	Each	12

Compatible WINCO® accessory: PL-8 lug box

### DELIVERY BAGS

- ◆ Outer shell/liner: polyester, Filling: EPE
- ◆ Heat retention: 2 hours @ 167°F; 4 hours @ 131°F; 6 hours @ 95°F

ITEM	DESCRIPTION	UOM	CASE
BGDV-12	12" x 12" x 12"	Each	6
BGDV-22	22" x 22" x 13"	Each	6

### PIZZA/DELIVERY BAGS



BGDV-SERIES



BGPZ-SERIES

### PIZZA BAGS

- ◆ Outer shell/liner: polyester, Filling: EPE
- ◆ Insulated lining to keep food warm for longer periods of time

ITEM	DESCRIPTION	UOM	CASE
BGPZ-18	18" x 18" x 5"	Each	6
BGPZ-20	20" x 20" x 5"	Each	6
BGPZ-24	24" x 24" x 5"	Each	6

### INSULATED ICE CADDY

- ◆ Can be used inside or outdoors, in hot or humid conditions
- ◆ Drain shelf keeps ice separate from the water, greatly increasing storage time
- ◆ Polyethylene molded body is durable and light-weight, top lid slides open
- ◆ Polyurethane foam insulation effectively keeps ice cold for several days
- ◆ Recessed front handle for convenient pulling or lifting
- ◆ No assembly required; oil caster wheel bearings before use
- ◆ 125 lb capacity
- ◆ NSF listed



### INSULATED ICE CADDY



IIC-29

IIC-SERIES NSF

ITEM	DESCRIPTION	SIZE	UOM	CASE
IIC-29	Ice Caddy w/Sliding Lid	Ext Dim: 23" x 31.5" x 29.25"	Set	1
IIC-C8	Caster for IIC-29	8"	Each	1
IIC-C5B	Brake Caster for IIC-29	5"	Each	1



### INGREDIENT BINS

- ◆ Ideal for mobile storage in the kitchen
- ◆ Advanced super-clasp lid design makes it easy to scoop ingredients without removing the entire cover
- ◆ Clear, plastic front cover makes it simple to identify the ingredients while keeping foods fresh longer
- ◆ 3" caster wheels with brakes make this bin convenient to move from one kitchen work area to another
- ◆ Scoop handle designed to remain out of ingredients and prevent contamination
- ◆ NSF listed

### INGREDIENT BINS



3" Caster Wheels with Brakes



Convenient Scoop Storage



IB-21

ITEM	DESCRIPTION	SIZE	UOM	CASE
IB-21	21 Gallon	13" x 29-1/4" x 28"	Set	1
IB-27	27 Gallon	15-1/2" x 29-1/2" x 28"	Set	1
IB-C3	Caster for IB-21 and IB-27	3"	Each	1
IB-C3B	Caster w/Brake for IB-21 & IB-27		Each	1
IB-21-LE	Lid for IB-21		Each	6
IB-27-LE	Lid for IB-27		Each	6

MODEL	WEIGHT SUGAR	WEIGHT FLOUR
IB-21	159 lbs	124 lbs
IB-27	197 lbs	154 lbs

IB-SERIES NSF





## HOT / COLD FOOD TRANSPORTERS



IFT-1



IFT-2  
Built-in dolly & casters



IFT-1 & IFT-1D



IFT-1D (INCLUDES STRAP)  
Can also be used with IFPC-series



INTERIOR VIEW IFT-1

### FULL-SIZE HOT/COLD FOOD TRANSPORTERS

- ◆ Molded with polypropylene and insulated with polyurethane foam to maintain safe food serving temperatures for hours without the use of electricity or sterno
- ◆ Adjustable vent cap equalizes outside and inside compartment pressure for easy lid opening
- ◆ Stackable and interlockable for easy storage, and space saving
- ◆ Standard food service pans are easy to load and remove
- ◆ Easy-to-clean holding compartments
- ◆ NSF listed

ITEM	DESCRIPTION	UOM	CASE
IFT-1	Single Insulated Food Pan Cart, NSF	Set	1
IFT-2	Double Insulated Food Pan Cart, Built-In Dolly	Set	1
IFT-1D	Dolly w/Cargo Strap for IFC-1	Set	1
IFT-C5	5" Caster for IFT-2	Each	1
IFT-C5B	5" Brake Caster for IFT-2	Each	1

**NSF** IFT-SERIES

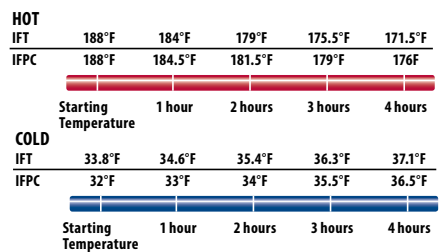

ITEM	DIMENSIONS	COMPARTMENT CAPACITY	
IFT-1	Exterior Dimensions: 18-3/4"W x 26-3/4"D x 24-1/2"H Interior Dimensions: 13-1/4"W x 21"D x 19-5/16"H	6 Full-Size, 2.5" H 4 Full-Size, 4" H 3 Full-Size, 6" H 4 Half-Size, 6" H	8 Half-Size, 4" H 9 1/3 Size, 6" H 12 1/3 Size, 4" H 6 1/3 Size, 8" H
IFT-2	Exterior Dimensions: 20"W x 27-1/2"D x 47-1/4"H Interior Dimensions for Each Compartment: 13-1/4"W x 21"D x 17"H	Each of the two compartments: 4 Full-Size, 2-1/2" H 3 Full-Size, 4" H 2 Full-Size, 6" H 10 Half-Size, 2-1/2" H	Can hold the following pans: 6 Half-Size, 4" H 4 Half-Size 6" H 6 1/3rd Size, 6" H 9 1/3rd Size, 4" H
IFT-1D		Use with IFT-1	



IFPC-4

### COMPACT HOT/COLD FOOD TRANSPORTER

- ◆ Compact carriers offer the perfect solution for transporting hot or cold foods
- ◆ NSF listed

ITEM	DESCRIPTION	UOM	CASE
IFPC-4	Up to 4" H Food Pans	Set	1

*Spare parts available for sale*



Adjustable vent cap on full-size and compact transporters



Stackable

ITEM	DIMENSIONS	COMPARTMENT CAPACITY
IFPC-4	Exterior Dimensions 24-3/4"L x 17-1/4"W x 8-1/4"H Interior Height: 4"	Holds 4" H Pans, 1 Full-Size / 2 Half-Size / 3 Third-Size

**NSF** IFPC-4

# *Snack & Refreshment*

## **EQUIPMENT** *Cook & Merchandise*



ACCELMIX™ BLENDERS

**ACCELMIX™**

by Winco®

ADD POWER & PERFORMANCE!



ETL Intertek US ETL Intertek XLB-1000

BPA FREE TRITAN™ CONTAINER

NEW



ETL Intertek US ETL Intertek XLB-44

BPA FREE TRITAN™ CONTAINER

New Item

ACCELMIX™ ELECTRIC COUNTERTOP BLENDERS

These commercial-grade blenders feature high-performance motors with impact-resistant stainless steel blades, adding power and performance to your busy establishment.

- ◆ Removable container covers and caps for adding/ blending ingredients mid-cycle
- ◆ All parts (except bases) are dishwasher safe
- ◆ ETL listed for electrical safety in US and Canada, conforms to UL-197 and CSA C22.2
- ◆ One year parts and labor warranty

EXTRA LARGE 68 OZ CAPACITY BLENDER

- ◆ 68 oz, break-resistant and BPA-free Tritan™ container
- ◆ High-performance 2 hp motor; unique high-impact blades
- ◆ Container/pitcher is heat-resistant up to 226°F (108°C); reduce pressure by removing cap in the lid
- ◆ 11-1/2" tamper included - fits through lid opening and reaches full length of container to blend/stir while mixing
- ◆ Metal-to-metal coupling; easy to operate "PULSE" and "ON/OFF" paddle controls, & variable speed control dial

- ◆ 120V~60Hz, 1450W, 12.1A
- ◆ Overall dimensions: 10"L x 9"W x 20"H
- ◆ Container: 6-1/4"L x 6-5/8"W x 11-1/2"H

ITEM	DESCRIPTION	UOM	CASE
XLB-1000	Accelmix 68 Oz Blender	Set	1/4
XLB1000P1	Rod Set	Each	1
XLB1000P2	Pitcher Assembly	Each	1
XLB1000P4	Refilling Cap	Each	1
XLB1000P5	Blade Assembly	Each	1
XLB1000P10	Mushroom Head Fitting	Each	1
XLB1000P11	68 oz Pitcher	Each	1



Cap removed, stirring tamper inserted



Blend fruits, ice and a variety of other ingredients

44 OZ BAR BLENDER

- ◆ 44 oz, break-resistant and BPA-free Tritan™ container
- ◆ Quiet, high-performance 1/2 hp self-lubricating motor; uniquely designed high-impact blades
- ◆ HIGH/LOW toggle switch for precise consistency control
- ◆ Blade is removable for easy cleaning
- ◆ Non-skid feet securely grip the surface for stable operation
- ◆ 120V~60Hz, 400W, 3.5A
- ◆ Overall: 7"L x 5"W x 15-1/4"H; container: 7"L x 5"W x 9"H

ITEM	DESCRIPTION	UOM	CASE
XLB-44	Accelmix 44 Oz Blender	Set	1/4
XLB44-P1	Filler Cap	Each	1
XLB44-P2	Container Lid	Each	1
XLB44-P3	44 oz Pitcher	Each	1
XLB44-P4	Gasket	Each	1
XLB44-P5	Blade Assembly	Each	1
XLB44-P6	Collar	Each	1
XLB44-P7	Clutch	Each	1



CONFECTIONARY MACHINES



**ELECTRIC COTTON CANDY MACHINE**

- ◆ Simple, easy-to-use controls
- ◆ Includes sugar scooper for pouring floss sugar
- ◆ 20-1/2" diameter bowl is stainless steel
- ◆ Spinner head accommodates 4 oz. of floss sugar
- ◆ Easy access to voltage meter and fuse for use on generators and power supplies
- ◆ Optional clear lid (sold separately) provides protection from wind and debris
- ◆ 120V~60Hz, 1080W, 9A
- ◆ Base unit dimensions: 20-1/2"L x 20-1/2"W x 19"H
- ◆ Cover only: 21"L x 21"W x 14"H
- ◆ One year parts and labor warranty

ITEM	DESCRIPTION	UOM	CASE
CCM-28	Cotton Candy Machine	Set	1
CCM-28C	Clear Plastic Dome Cover	Each	1/5
CCM28-P3	Replacement Belt	Each	1
CCM28-P5	Sugar Spoon	Each	1



CCM-28

**POPCORN POPPERS**

- ◆ 8 oz stainless steel kettle is removable; POP-8R includes non-stick kettle
- ◆ Built-in warmer light
- ◆ Removable crumb tray
- ◆ Tempered glass side panels
- ◆ Clear plexiglass doors and stainless steel fold-out tray for easy access
- ◆ POP-8B: 120V-60Hz, 1130W, 9.5A
- ◆ Overall Dimensions: 15-3/4"L x 14-3/4"W x 23"H
- ◆ POP-8R: 120V-60Hz, 1350W, 12A
- ◆ Overall Dimensions: 22"L x 16-1/2"W x 30"H
- ◆ One year parts and labor warranty

ITEM	DESCRIPTION	UOM	CASE
POP-8B	Black Popcorn Popper	Set	1
POP-8R	Red Popcorn Popper, Teflon® Coated Non-Stick Kettle	Set	1
POP8-P1	Non-stick Pot for POP-8R	Each	1
POP8-P2	Replacement Pot for POP-8R	Each	1



POP-8R



POP-8B



REFRIGERATED COLD BEVERAGE DISPLAY

LED LIGHTED



The grate below door flips down to access On/Off switch

CRD-1  
White

COUNTERTOP REFRIGERATED BEVERAGE DISPLAYS

With its clear panels and 4 LED light strips, this countertop display can keep up to 100 standard 12 oz cans chilled.

- ◆ Digital temperature display from 34°F to 44°F
- ◆ 360° view of refrigerated product
- ◆ 2 double-glass doors for versatile placement and easy access
- ◆ 4 LED strips for effective product lighting
- ◆ Comfortably fits up to 100 cans (standard 12 oz) with 25 cans per shelf
- ◆ 4-level, durable PVC-coated shelves; three (3) are adjustable to fit multiple product heights
- ◆ Automatic defrost and ventilated cooling system
- ◆ 120V~60Hz, 230W, 2.7A
- ◆ Overall Dimensions: 17"L x 17"W x 39"H
- ◆ Each shelf: 13-3/4"L x 14"W
- ◆ One year parts and labor warranty

ITEM	DESCRIPTION	UOM	CASE
CRD-1	White	Set	1
CRD-1K	Black	Set	1

**IMPORTANT**

This unit is intended for use in commercial food-service operations, for the cooling and display of sealed food and beverage only.



CRD-1K  
Black

The grate below door flips down to access On/Off switch



Comfortably fits 100 cans



CRD-SERIES

**ELECTRIC HEATED PIZZA/PRETZEL MERCHANDISERS**

Passive humidity control with removable water tray.

- ◆ Interior wire shelves hold four (4) 14" pizzas
- ◆ Optional pretzel rack insert, sold separately
- ◆ Display tray/rack insert rotates when door is closed
- ◆ Lighted display panel for branding visuals
- ◆ Removable crumb tray
- ◆ 120V~60Hz, 786W, 7.2A
- ◆ Overall Dimensions: 18"L x 17-1/2"W x 31"H
- ◆ One year parts and labor warranty

ITEM	DESCRIPTION	UOM	CASE
EDM-2	Pizza/Pretzel Merchandiser	Set	1
EDM-2PR	Optional Pretzel Rack Insert	Set	1
EDM-2PRS	Pretzel Sign, 5-3/4"H x 16-1/8"W	Each	1
EDM-2PZS	Pizza Sign, 5-3/4"H x 16-1/8"W	Each	1
EDM-P58	Pizza Rack	Each	1



EDM-2PRS



EDM-2PZS

Translucent Plastic Display Signs Available for EDM-2, Sold Separately



EDM-2



EDM-2PR  
Optional Pretzel Rack

**COUNTERTOP HEATED DISPLAY MERCHANDISERS**

- ◆ Removable water pan to add and control humidity
- ◆ Three (3) adjustable shelves inside, top can also be used as a shelf
- ◆ Lighted front display for branding visuals
- ◆ Visible thermometer gauge to ensure food keeps at proper temperatures
- ◆ Adjustable thermostat from 85°F to 195°F (30°C to 90°C)
- ◆ Customer-facing front service and rear access doors
- ◆ All units are 26" tall
- ◆ HDM-13: 120V~60Hz, 800W, 7.6A
- ◆ HDM-26: 120V~60Hz, 1000W, 9.5A
- ◆ One year parts and labor warranty

ITEM	DESCRIPTION	UOM	CASE
HDM-13	13-1/2"L	Set	1
HDM-26	26-1/2"L	Set	1



HDM-13  
13.6"L X 19"W X 26"H



Control Panel



HDM-26  
26.6"L X 19"W X 26"H



HDM-SERIES

**ELECTRIC COFFEE WARMERS**  **ELECTRIC COFFEE WARMERS**

*Keep coffee fresh, hot and ready to serve at the optimal serving temperature. Coffee warmers are ideal for any self-service area.*



ECW-2S

- ◆ Low-profile for maximum product visibility and space-saving
- ◆ Durable stainless steel body with ceramic-coated plates
- ◆ Separate lighted on/off switches for convenient operation
- ◆ ETL listed for safety and sanitation
- ◆ 120V~60Hz, 100W per burner
- ◆ One year parts and labor warranty

ITEM	DESCRIPTION	UOM	CASE
ECW-1	Single Burner, 100W	Each	1/6
ECW-2	Double Burners, 200W	Each	1/6
ECW-2S	Step-Up Double Burner, 200W	Each	1



ECW-1



ECW-2



ECW-SERIES

### ELECTRIC ROUND FOOD COOKER/WARMER, 1250W

With highly efficient heating distribution, Winco's durable and reliable food cooker/warmer is a workhorse that can endure the harshest kitchen environments.

- ◆ Insulated heating compartment for maximum efficiency
- ◆ No-drip rim keeps serving area clean
- ◆ Heats up to 212°F (100°C)
- ◆ ETL listed for electrical safety, conforms to UL-197
- ◆ ETL listed for sanitation, conforms to NSF-4
- ◆ 120V~60Hz, 1250W, 10.5A
- ◆ Overall Dimensions: 12-1/2"L x 12-1/2"W x 9-5/8"H
- ◆ Inner well fits 11qt inset pot
- ◆ One year parts and labor warranty

ITEM	DESCRIPTION	UOM	CASE
FW-11R500	Round Cooker/Warmer	Set	1

### ELECTRIC 11QT ROUND FOOD COOKER/WARMER, 1250W



NEW

FITS 11QT INSET POT

ETL Intertek ETL Intertek  
FW-11R500

### ELECTRIC FOOD COOKER/WARMER, 1500W

The unique design of this multitasker meets and exceeds standard NSF-4 rethermalization testing requirements.

- ◆ Energy-efficient insulated heating compartment for maximum efficiency
- ◆ Easy control settings cook and keep food at the right temperature all day; monitor status with the indicator light
- ◆ Stainless steel body with vented sides
- ◆ 3 settings: Low = 140°F / Medium = 170°F / High = 200°F
- ◆ ETL listed for electrical safety, conforms to UL-197
- ◆ ETL listed for sanitation, conforms to NSF-4
- ◆ 120V~60Hz, 1500W, 12.5A
- ◆ Overall dimensions: 22-1/2"L x 14-5/8"W x 10-5/8"H
- ◆ Inside dimensions: 20"L x 12"W x 6"H
- ◆ Standard 20" x 12" opening; holds full-size pans up to 6" deep
- ◆ One year parts and labor warranty

ITEM	DESCRIPTION	UOM	CASE
FW-S600	Cooker/Warmer	Set	1
FWS600-P5	Power/Thermostat Knob	Each	1/50

### ELECTRIC FOOD COOKER/WARMER, 1500W



ETL Intertek ETL Intertek  
FW-S600

### ELECTRIC FOOD WARMER, 1200W

- ◆ Energy-efficient design heats faster; lower utility costs
- ◆ Heavy-duty stainless steel body for commercial use
- ◆ 3 settings: Low = 140°F / Medium = 170°F / High = 200°F
- ◆ ETL listed for electrical safety, conforms to UL-197
- ◆ ETL listed for sanitation, conforms to NSF-4
- ◆ 120V~60Hz, 1200W, 10A
- ◆ Overall Dimensions: 22-1/2" L x 14-5/8" W x 9-3/8" H
- ◆ Inside Dimensions: 20"L x 12"W x 6"H
- ◆ Standard 20" x 12" opening fits most full-size pans up to 6" deep
- ◆ One year parts and labor warranty

ITEM	DESCRIPTION	UOM	CASE
FW-S500	Warmer	Set	1
FWS500-P11	Power/Thermostat Knob	Each	1/50

### ELECTRIC FOOD WARMER, 1200W



ETL Intertek ETL Intertek  
FW-S500



## ELECTRIC STRIP HEATERS

**NEW**



ESH-24



ESH-36

Shown with undermount bracket and hanging chain



ESH-60



### ELECTRIC STRIP HEATERS

- ◆ Ideal for pass-through stations
- ◆ Each unit includes: undermount bracket set w/screws (ESH-UB), hanging chains (ESH-CH), built-in cord w/plug to easily connect to electrical outlet
- ◆ Heavy-duty aluminum construction
- ◆ Tubular sheath heating element provides constant and reliable infrared heating
- ◆ Five (5) lengths: 24"L / 36"L / 48"L / 60"L / 72"L
- ◆ One year parts and labor warranty

ITEM	DESCRIPTION	SIZE	UOM	CASE
ESH-24	120V~60Hz, 500W, 4.2A	24"L	Set	1
ESH-36	120V~60Hz, 850W, 7A	36"L	Set	1
ESH-48	120V~60Hz, 1100W, 9.1A	48"L	Set	1
ESH-60	120V~60Hz, 1400W, 12A	60"L	Set	1
ESH-72	120V~60Hz, 1750W, 14.6A	72"L	Set	1

INCLUDES HANGING CHAINS  
BUILT-IN PLUG



ESH-SERIES



Heating element



Indicator light and toggle switch

## ELECTRIC STRIP HEATER WITH STAND



ESH-1

### ELECTRIC STRIP HEATER WITH STAND

- ◆ Includes undermount bracket and bolt set (ESH-UB) for optional mounting under shelves
- ◆ Extruded aluminum body for durability and cleanliness
- ◆ Tubular sheath heating element provides constant, even, reliable infrared heating
- ◆ Stand adjusts to three height positions: 17-1/2"H, 20"H, and 22-1/2"H
- ◆ 120V~60Hz, 500W, 4.2A
- ◆ Dimensions w/base: 25-1/2"L x 14"W x various heights
- ◆ Without base: 24"L x 6"W x 2-1/2"H
- ◆ One year parts and labor warranty

ITEM	DESCRIPTION	UOM	CASE
ESH-1	Electric Strip Heater	Set	1



**PROFESSIONAL ELECTRIC FREESTANDING HEAT LAMP**

Keep prepared food warm and appetizing at ideal serving temperatures under the twin-bulb infrared heat lamp, featuring maximum adjustability and improved stability on countertop surfaces.

- ◆ Extra heavy-duty 14 gauge aluminum frame with 1-1/8" jumbo square tube
- ◆ Includes two (2) shatter-resistant, clear, infrared 250W/120V bulbs
- ◆ Lightweight all-aluminum design
- ◆ 4-position adjustable height
- ◆ 6 foot power cord
- ◆ ETL listed for electrical safety in US and Canada, conforms to UL-197 and CSA C22.2
- ◆ ETL listed for sanitation, conforms to NSF-4
- ◆ 120V~60Hz, 250W x2, 2.1A x 2
- ◆ Dimensions: 19-1/2"L x 14-1/4"W x four height positions
- ◆ Base: 16-1/4"L x 14-1/4"W
- ◆ One year parts and labor warranty

ITEM	DESCRIPTION	UOM	CASE
EHL-2	4-Position Heat Lamp	Set	1
EHL-BR	Replacement Bulb for EHL-2, 250W, 2.1A, Red	Each	1/12
EHL-BW	Replacement Bulb for EHL-2, 250W, 2.1A, Clear	Each	1/12

**PROFESSIONAL ELECTRIC FREESTANDING HEAT LAMP**



1 1/8" Square Tubing  
Larger  
Provides Extra Sturdiness & Better Stability

INCLUDES 2 CLEAR, INFRARED 250W/120V BULBS



**ELECTRIC HEAT LAMP**

Maintain ideal serving temperatures to keep prepared food warm and appetizing under this infrared twin-bulb heat lamp, featuring maximum adjustability, improved countertop stability and an easy-to-clean, scratch-resistant finish.

- ◆ Keeps plated foods at optimal serving temperatures
- ◆ Heavy-duty steel tubing
- ◆ Easy-to-clean, durable scratch-resistant electrostatic powder coated finish on hoods and frame
- ◆ 3-position adjustable height for controlling heat intensity
- ◆ Compatible with most standard-size food trays
- ◆ Includes two (2) shatter-resistant, clear, infrared 250W/120V bulbs
- ◆ 6 foot power cord
- ◆ ETL listed for electrical safety in US and Canada, conforms to UL-197 and CSA C22.2
- ◆ ETL listed for sanitation, conforms to NSF-4
- ◆ 120V~60Hz, 250W x2, 2.1A x 2
- ◆ Three height positions: 24", 26.5", or 29"
- ◆ Base: 18"L x 14"W
- ◆ One year parts and labor warranty

ITEM	DESCRIPTION	UOM	CASE
EHL-2C	3-Position Heat Lamp	Set	1

**ELECTRIC HEAT LAMP**



INCLUDES 2 CLEAR, INFRARED 250W/120V BULBS



## ELECTRIC COUNTERTOP SANDWICH GRILLS



ESG-1



ESG-2



## COUNTERTOP SANDWICH GRILLS

*Flat-top grills are great for not only sandwiches, but are widely used for breakfast eggs and meats, flat breads, quesadillas and more!*

- ◆ Stainless steel construction; flat cast iron grill surface
- ◆ Hinged balanced top plate adjusts to food thickness
- ◆ Removable crumb and grease tray
- ◆ Power and ready light(s)
- ◆ Adjustable thermostat(s) up to 600°F
- ◆ ETL listed for electrical safety in US and Canada, conforms to UL-197 and CSA C22.2
- ◆ ETL listed for sanitation, conforms to NSF-4
- ◆ One year parts and labor warranty

### SINGLE SANDWICH GRILL

- ◆ Grill surface: 14" x 9"; overall: 17"L x 12"W x 8"H
- ◆ 120V~60Hz, 1750W, 15A

ITEM	DESCRIPTION	UOM	CASE
ESG-1	Single Grill	Set	1
EP5G-P52S	Handle	Each	1
EP5G-P28	Thermostat Black Knob & Red Ring	Each	1

### DOUBLE SANDWICH GRILL

- ◆ Grill surface: 19" x 9"; overall: 22-1/2"L x 12"W x 8"H
- ◆ 120V~60Hz, 1750W x2, 15A x 2

ITEM	DESCRIPTION	UOM	CASE
ESG-2	Double Grill	Set	1
EP5G-P52D	Handle	Each	1
EP5G-P28	Thermostat Black Knob & Red Ring	Each	1

## ELECTRIC COUNTERTOP DEEP FRYERS



Cover(s) for well(s) are included



EFS-16



## COUNTERTOP DEEP FRYERS

*Countertop fryers are a great, easy addition to any food service operation. Great for chicken, fries, onion rings, tempura, shrimp, vegetables and more!*

- ◆ Commercial fry basket(s) with safe secure handle
- ◆ Expedient heat-up
- ◆ Removable stainless steel fry well(s) for easy cleaning; fry well cover(s) included
- ◆ Removable power head(s)
- ◆ ETL listed for electrical safety in US and Canada, conforms to UL-197 and CSA C22.2
- ◆ ETL listed for sanitation, conforms to NSF-4
- ◆ One year parts and labor warranty

### ELECTRIC COUNTERTOP SINGLE WELL DEEP FRYER

- ◆ 16 lb oil capacity
- ◆ 8 liters = 16 lbs = 2.3 gallons
- ◆ Overall dimensions: 11-3/4"L x 16"W x 13-5/8"H
- ◆ 120V~60Hz, 1750W, 15A

ITEM	DESCRIPTION	UOM	CASE
EFS-16	Single Well	Set	1
EFST-P30	Fry Basket	Each	1

### ELECTRIC COUNTERTOP TWIN WELL DEEP FRYER

- ◆ 32 lb oil capacity
- ◆ 2 x 8 liters (16 liters combined) = 32 lbs; total = 4.8 gallons
- ◆ Overall dimensions: 21-1/4"L x 16"W x 13-5/8"H
- ◆ 120V~60Hz, 1750W x 2, 15A x 2

ITEM	DESCRIPTION	UOM	CASE
EFT-32	Double Well	Set	1
EFST-P30	Fry Basket	Each	1



EFT-32



**COUNTERTOP SINGLE PANINI GRILL**

*This versatile grill can be used in many types of food service operation from paninis and wraps, to grilled vegetables or chicken.*

- ◆ Ribbed cast iron 14" x 12" grill surface
- ◆ Hinged balanced top plate adjusts to food thickness
- ◆ Removable crumb and grease tray
- ◆ Power and ready light(s)
- ◆ Stainless steel construction
- ◆ Adjustable thermostat(s) up to 570°F
- ◆ ETL listed for electrical safety in US and Canada, conforms to UL-197 and CSA C22.2
- ◆ ETL listed for sanitation, conforms to NSF-4
- ◆ 120V~60Hz, 1800W, 15A
- ◆ One year parts and labor warranty

ITEM	DESCRIPTION	UOM	CASE
EPG-1C	Single Grill w/Cleaning Brush	Set	1
EP5G-P52S	Handle	Each	1

**ELECTRIC COUNTERTOP PANINI GRILLS**



Closed



**NEW**

**NEW & IMPROVED QUALITY**



EPG-1C

**COUNTERTOP PANINI GRILLS**

- ◆ Ribbed cast iron grill surface
- ◆ Hinged balanced top plate adjusts to food thickness
- ◆ Removable crumb and grease tray
- ◆ Power and ready light(s)
- ◆ Stainless steel construction
- ◆ Adjustable thermostat(s) to 600°F
- ◆ ETL listed for electrical safety in US and Canada, conforms to UL-197 and CSA C22.2
- ◆ ETL listed for sanitation, conforms to NSF-4
- ◆ One year parts and labor warranty



EPG-1

**SINGLE PANINI GRILL**

- ◆ Grill surface: 14" x 9"
- ◆ Overall dimensions: 17"L x 12"W x 8"H
- ◆ 120V~60Hz, 1750W, 15A

ITEM	DESCRIPTION	UOM	CASE
EPG-1	Single Grill	Set	1

**DOUBLE PANINI GRILL**

- ◆ Grill surface: 19" x 9"
- ◆ Overall dimensions: 22-1/2"L x 12"W x 8"H
- ◆ 120V~60Hz, 1750W x 2, 15A x 2

ITEM	DESCRIPTION	UOM	CASE
EPG-2	Double Grill	Set	1



EPG-2



EPG-SERIES



## ELECTRIC COUNTERTOP CONVECTION OVENS

AVAILABLE IN MARCH 2018



ECO-250



ECO-500

### ELECTRIC COUNTERTOP CONVECTION OVENS

- ◆ Stainless steel construction
- ◆ Built-in 120 minute timer with "Stay On" feature
- ◆ Dual pane tempered glass door
- ◆ Spacious interior includes three chrome wire shelves
- ◆ Whisper quiet circulation for even heating
- ◆ ETL listed for electrical safety in US and Canada, conforms to UL-197 and CSA C22.2
- ◆ ECO-250: 120V~60Hz, 1440W, 12A
- ◆ Overall Dimensions: 18-3/4"L x 19-7/8"W x 15"H
- ◆ ECO-500: 120V~60Hz, 1600W, 13.3A
- ◆ Overall Dimensions: 22-1/2"L x 22-3/4"W x 17-3/4"H
- ◆ One year parts and labor warranty

ITEM	DESCRIPTION	UOM	CASE
ECO-250	Quarter-Size, 0.8 Cubic Ft	Set	1
ECO-500	Half-Size, 1.5 Cubic Ft	Set	1
ECO-P5-25	Wire Rack for ECO-250	Each	1
ECO-P5-50	Wire Rack for ECO-500	Each	1



Spacious interior

## COMMERCIAL ELECTRIC INDUCTION COOKER



120V



EIC-400



240V

NEW



EIC-400B



### COMMERCIAL ELECTRIC INDUCTION COOKER

*Safer than traditional gas or electric resistance burners, induction cooktops use magnetism to rapidly heat up induction cookware, which in turn heats up food. The ideal choice for tableside, catering and buffet line cooking, induction cooktops are faster and more efficient than installed gas stovetops.*

- ◆ Digitally controlled wattage and temperature
- ◆ Strong, enduring 11" x 11" German SCHOTT™ ceramic glass cooking surface
- ◆ Adjustable heat from 120°F to 460°F (50°C to 240°C)
- ◆ Durable stainless steel body construction
- ◆ Timer up to 150 min (2-1/2 hours)
- ◆ Feet are adjustable for added stability
- ◆ Auto safety shut-off at 2-1/2 hours
- ◆ EIC-400: 120V~60Hz, 1800W, 15A
- ◆ EIC-400B: 240V~60Hz, 3200W, 13.3A
- ◆ Dimensions: 16-1/2"L x 13"W x 4"H
- ◆ One year warranty

ITEM	DESCRIPTION	UOM	CASE
EIC-400	120V Induction Cooker	Each	1/2
EIC-400B	240V Induction Cooker	Each	1/2

### ELECTRIC COUNTERTOP PIZZA OVEN

- ◆ Heats up to 700°F (371°C); dual independently controlled heating elements
- ◆ 60-minute timer with bell includes "Stay On" feature
- ◆ Pizza tray handle folds for storage
- ◆ Includes crumb tray
- ◆ Easily fits a pizza up to 12" diameter
- ◆ 120V~60Hz, 1500W, 12.5A
- ◆ Dimensions: 20-7/8"L x 14-3/4"W x 9-1/4"H
- ◆ One year parts and labor warranty

ITEM	DESCRIPTION	UOM	CASE
EPO-1	Pizza Oven w/Bell Timer and "Stay On" Function	Set	1
EPO-P7	Handle & Knob for EPO-1	Each	1

### ELECTRIC PIZZA OVEN



IMPROVED QUALITY

Easily fits 12" pizza



EPO-1

### PORTABLE BUTANE STOVE

*This portable and compact butane stove is great for camping, outdoor parties or catered events.*

- ◆ Single, top-quality solid brass burner, built-in pot support and wide base for stability
- ◆ Manually adjustable heat range with up to 9,500 BTU of power
- ◆ Comes with a black impact-resistant hard plastic carrying case for easy transport
- ◆ Automatic gas shut-off safety feature
- ◆ Uses standard 8 oz Butane DOT-2P canister (sold separately)
- ◆ CSA listed for commercial and outdoor use

ITEM	DESCRIPTION	UOM	CASE
PGS-1K	Portable Gas Cooker, Black, 9500 BTUs, Brass Burner w/Case	Each	1/6

### BUTANE STOVE

SUPERIOR BRASS BURNER



Fits standard Butane canister



PGS-1K



### ELECTRIC WATER PAN

- ◆ Stands alone or fits standard full-size chafer frames for an electric alternative (food pan sold separately)
- ◆ Accommodates full-size steam table pans
- ◆ Adjustable temperature
- ◆ Powerful, efficient 900W heating element heats up fast
- ◆ 120V~60Hz, 900W, 7.5A
- ◆ Dimensions: 22-5/8"L x 13-5/8"W x 7"H
- ◆ One year parts and labor warranty

ITEM	DESCRIPTION	UOM	CASE
EWP-2	900W, Full Size	Each	1

### ELECTRIC 900W WATER PAN



Fits inside standard full-size chafer

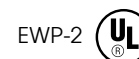

EWP-2

## ELECTRIC RICE COOKER



RC-P300



RC-SERIES

## ELECTRIC RICE COOKER

Assembled with premium electrical parts from Korea and Japan, Winco's electric rice cooker makes up to 60 cups of delicious rice.

- ◆ Holds up to 30 cups of uncooked rice
- ◆ Inner pot seals in moisture
- ◆ Includes cover, inner pot, measuring cup and serving paddle
- ◆ ETL listed for electrical safety, conforms to UL-197 and UL-1026
- ◆ ETL listed for sanitation, conforms NSF-4
- ◆ 110V~50-60Hz, 1550W, 14A
- ◆ Dimensions: 15-11/16"L x 15-11/16"W x 12-3/8"H
- ◆ One year parts and labor warranty

ITEM	DESCRIPTION	UOM	CASE
RC-P300	Rice Cooker	Set	1
RC-P300PN	Inner pot for RC-P300P	Each	1
RC-F	Fuse for RC-S300 & RC-P300 Can be used in most commercial rice cookers	Each	1/50

## ELECTRIC RICE COOKER/WARMER



RC-S300



RC-SERIES

## ADVANCED ELECTRIC RICE COOKER/ WARMER WITH HINGED COVER

Both a cooker and warmer, the Advanced Electric Rice Cooker from Winco is designed to keep rice at the ideal serving temperature and texture.

- ◆ Holds 30 cups of uncooked rice or 60 cups of cooked rice
- ◆ Fingerprint-proof satin finish; heavy-duty stainless steel body
- ◆ Non-stick inner pot seals in moisture
- ◆ Energy efficient heat absorption system
- ◆ Automatically keeps rice warm for up to 6 hours
- ◆ Major electrical parts made in Korea/Japan
- ◆ Includes inner pot, measuring cup and serving paddle
- ◆ ETL listed for electrical safety, conforms to UL-197 and UL-1026
- ◆ ETL listed for sanitation, conforms to NSF-4
- ◆ 110V~50-60Hz, 1550W, 14A
- ◆ Dimensions: 17-1/2"L x 17-1/2"W x 15"H
- ◆ One year parts and labor warranty

ITEM	DESCRIPTION	UOM	CASE
RC-S300	Rice Cooker/Warmer, Hinged Lid	Set	1
RC-S300PN	Inner pot for RC-S300	Each	1
RC-F1	Fuse for RC-S300	Each	1

**ELECTRIC 100-CUP RICE WARMER**

Premium electrical parts are the foundation for the consistent quality and dependability of this 100-cup electric rice warmer from Winco.

- ◆ Holds 100 cups of uncooked rice
- ◆ Fingerprint-proof satin finish; heavy-duty stainless steel body
- ◆ Non-stick inner pot seals in moisture
- ◆ Energy efficient heat absorption system
- ◆ Keeps contents warm for up to 24 hours
- ◆ Major electrical parts made in Korea/Japan
- ◆ ETL listed for electrical safety, conforms to UL-197 and UL-1026
- ◆ ETL listed for sanitation, conforms to NSF-4
- ◆ 120V~60Hz, 84W, 1.4A
- ◆ Dimensions: 16-13/16"L x 16-13/16"W x 17-1/2"H
- ◆ One year parts and labor warranty

ITEM	DESCRIPTION	UOM	CASE
RW-S450	Electric Rice Warmer, 100-Cup	Set	1
RW-450P	Inner pot for RW-S450	Each	1
RW-F	Fuse for RW-S450 Can be used in most commercial rice warmers	Each	48/192

**ELECTRIC 100-CUP RICE WARMER**



RW-S450



**PANASONIC 23-CUP COMMERCIAL ELECTRIC RICE COOKER**

- ◆ Stainless steel lid; removable aluminum alloy inner pot
- ◆ Built-in thermal safety fuse
- ◆ Automatic shut-off
- ◆ Keeps rice warm up to 2 hours
- ◆ ETL listed for electrical safety in US and Canada, conforms to UL-197 and CSA C22.2
- ◆ NSF Listed
- ◆ 120V~60Hz, 1550W, 13A
- ◆ Dimensions: 16-7/8"L x 14-7/8"W x 11-7/8"H
- ◆ One year manufacturer-direct warranty
- ◆ Panasonic warranty only covers purchases made in the United States

ITEM	DESCRIPTION	UOM	CASE
SR-42H2P-D	Panasonic Rice Cooker	Set	1

**PANASONIC ELECTRIC RICE COOKER**



SR-42H2P-D





**ELECTRIC SOUP WARMERS**



ESW-70

The extra large kettle-style soup warmers keep contents at safe serving temperatures for hours on end, great for serving all day.

- ◆ 10-quart capacity warms and holds soup
- ◆ Adjustable heat control keeps contents at a safe serving temperature without over-cooking
- ◆ Stainless steel hinged lid allows cover to remain attached while opened and closed during service with no drips
- ◆ Includes removable 18/8 stainless steel bain marie inner pot
- ◆ Outer surface stays cool to the touch thanks to double-wall construction
- ◆ ETL listed for electrical safety in U.S.A. and Canada, conforms to UL-197 and CSA C22.2
- ◆ ETL listed for sanitation, conforms to NSF-4
- ◆ 120V~60Hz, 400W, 3.3A
- ◆ Dimensions: 13-3/16"L x 13-3/16"W x 15"H
- ◆ One year parts and labor warranty



ESW-66

**ELECTRIC STAINLESS STEEL SOUP WARMER**

- ◆ Includes suction label holder

ITEM	DESCRIPTION	UOM	CASE
ESW-70	Soup Warmer Set	Set	1

**ELECTRIC DELUXE SOUP WARMER**

- ◆ Includes customizable magnetic label holder and a variety of pre-printed soup names

ITEM	DESCRIPTION	UOM	CASE
ESW-66	Black Soup Warmer Set	Set	1

**PARTS FOR SOUP WARMERS**

ITEM	DESCRIPTION	UOM	CASE
ESW-INS	Insert Pot	Each	2
INSH-7	Hinged Cover	Each	6/24



INSH-7



ESW-SERIES

# SPECTRUM

COUNTERTOP EQUIPMENT



**FOR THE GROWING  
ESTABLISHMENT**

By **Winco**<sup>®</sup>

COMMERCIAL STAINLESS STEEL  
**TOUCH CONTROL  
 MICROWAVE**



EMW-1000ST

MODEL	VOLTAGE	INPUT POWER (W)	OUTPUT POWER (W)	AMPS	OVEN CAPACITY	DIMENSIONS (INCHES)			LBS
						WIDTH	DEPTH	HEIGHT	
EMW-1000ST	120 V	1450 W	1000 W	12	0.9 Ft <sup>3</sup>	20.1"	17"	12.2"	32.19



A durable, attractive full **stainless steel exterior and interior** construction highlights the powerful and efficient **SPECTRUM TOUCH CONTROL MICROWAVE**. Offering 1000W of microwave power, this microwave is ideal for heating and warming grab-and-go items, soups, sandwiches, prepackaged lunches, beverages, and more at your concession stand, lunch room, snack bar, office, or quick-serve establishment. Built with the commercial user in mind, this unit accommodates 10 easy-to-program functions including defrost, and will withstand repeated use in a professional, high-volume environment. The unique motor-driven bottom antenna provides efficient energy distribution, peak performance, and consistent results to keep your establishment moving with ease. With multiple power levels and adjustable time intervals, as well as a spacious 0.9 cubic feet oven cavity, this microwave is flexible enough to accommodate a variety of items to meet all your cooking and warming needs.

- ◆ 1,000 watts of cooking power for quick heating
- ◆ Motor driven bottom antenna for efficient energy distribution and consistent results
- ◆ Engineered for commercial kitchen use
- ◆ Stainless steel interior with bottom ceramic plate
- ◆ Ample 0.9 cubic feet (25 L) oven capacity
- ◆ Accommodates 12" (30.5 cm) diameter platter
- ◆ Backlit LED display
- ◆ Interior oven light
- ◆ 3 customizable key beep volume levels
- ◆ Overall dimensions: 20.1"W x 17"D x 12.2"H
- ◆ One year warranty

ITEM	DESCRIPTION	UOM
EMW-1000ST	Spectrum Commercial Microwave, Touch, Stainless Steel, 1,000 W	Set

# COMMERCIAL STAINLESS STEEL DIAL CONTROL MICROWAVE



EMW-1000SD

MODEL	VOLTAGE	INPUT POWER (W)	OUTPUT POWER (W)	AMPS	OVEN CAPACITY	DIMENSIONS (INCHES)			LBS
						WIDTH	DEPTH	HEIGHT	
EMW-1000SD	120 V	1450 W	1000 W	12	0.9 Ft <sup>3</sup>	20.5"	17.9"	12.3"	42.55



Built with convenience, speed, operability, and durability in mind, the **SPECTRUM DIAL CONTROL MICROWAVE** provides quick heating capabilities via 1000W of microwave power, making it ideal for warming soups, sandwiches, prepackaged lunches, beverages, and more. Engineered for commercial kitchen use, this microwave features an all **stainless steel exterior and interior**, compared to competitors' painted interior units. Additionally the ceramic heating plate features a bottom energy feed system, allowing for peak performance, efficient energy distribution, and consistent results. With multiple power levels and adjustable time intervals, as well as a spacious 0.9 cubic feet oven cavity, this microwave is flexible enough to accommodate a variety of items to meet all your cooking and warming needs.

- ◆ 1,000 watts of cooking power for quick heating
- ◆ Motor driven bottom antenna for efficient energy distribution and consistent results
- ◆ Engineered for commercial kitchen use
- ◆ Stainless steel interior with bottom ceramic plate
- ◆ Ample 0.9 cubic feet (25 L) oven capacity
- ◆ Accommodates 12" (30.5 cm) diameter platter
- ◆ Customizable cooking timer up to 60 minutes
- ◆ Backlit LED display
- ◆ Interior oven light
- ◆ Overall dimensions: 20.5"W x 17.9"D x 12.3"H
- ◆ One year warranty

ITEM	DESCRIPTION	UOM
EMW-1000SD	Spectrum Commercial Microwave, Dial, Stainless Steel, 1,000 W	Set





# ROLLSRIGHT™ COMMERCIAL ROLLER GRILLS



EHD-50NS



EHD-30NS

Sneeze Guard & Bun Drawer Sold Separately

EHD-30NS with EHD-30-SG & EHD-30-BD



EHD-30NS and EHD-50NS made with

MODEL	VOLTAGE	POWER (W)	AMPS	DIMENSIONS (INCHES)			LBS
				WIDTH	DEPTH	HEIGHT	
EHD-30NS	120V	1430W	12A	23.6"	20.5"	13.1"	41.01
EHD-50NS	120V	1760W	14.6A	35.4"	20.5"	13.1"	56.33



Non-Stick Rollers



**SPECTRUM ROLLER GRILLS** are engineered to give you long lasting cooking results under the harshest applications. They are perfect for convenience stores, concession stands, cafeterias and more. All grills come with our unique noise suppression motor and chain drive system. Dual temperature controls allow for both cooking and holding areas to operate independently, reducing waste and spoilage due to excessive overheating. Xylan® RollsRight™ non stick roller surfaces are durable and easy to clean. Spectrum Roller Grills come with full size grease drip pans and are UL, CUL, and NSF listed. Warranty and national onsite service program information can be found in the user manual.

- ◆ EHD-30NS: Up to 30 hot dog capacity
- ◆ EHD-50NS: Up to 50 hot dog capacity
- ◆ Stainless steel body and drip tray
- ◆ The rollers are coated using Whitford Xylan®, a fluoropolymer coating with superior resistance to wear and to all forms of abrasion
- ◆ Two-zone front and rear heating for cooking and warming simultaneously
- ◆ Multiple power levels to support different food products
- ◆ UL-listed for compliance with UL-197
- ◆ NSF-listed for compliance with NSF-4
- ◆ One year parts and labor warranty

ITEM	DESCRIPTION	UOM
EHD-30NS	30-Dog Hot Dog Roller, Non-Stick with Xylan Coating	Set
EHD-50NS	50-Dog Hot Dog Roller, Non-Stick with Xylan Coating	Set
EHD-P12	Replacement Knob for EHD-30NS & EHD-50NS	Each



ROLLSRIGHT™ COMMERCIAL ROLLER GRILL  
**SNEEZE GUARDS & BUN DRAWERS**



EHD-50-SG



EHD-50-SGD



EHD-30-BD



EHD-30-SGD



EHD-50-BD



EHD-30NS with  
EHD-30-SG and EHD-30-BD

MODEL	ITEM	DETAIL	DIMENSIONS (INCHES)			LBS
			WIDTH	DEPTH	HEIGHT	
EHD-30-SG	Sneeze Guard	Pass-Thru	24.375"	20.625"	9"	4.37
EHD-30-SGD	Sneeze Guard	Front Open Door	24.375"	21.275"	9.375"	4.5
EHD-30-BD	Bun Drawer	Holds Up to 36 Buns	23.5"	22"	8.5"	34.17
EHD-50-SG	Sneeze Guard	Pass-Thru	35.5"	20.625"	9"	5.95
EHD-50-SGD	Sneeze Guard	Front Open Door	36.175"	21.275"	9.375"	6.5
EHD-50-BD	Bun Drawer	Holds Up to 56 Buns	35.5"	22"	8.5"	49.6



**SPECTRUM SNEEZE GUARDS** are made of durable clear polycarbonate on a strong metal base, reliable and essential additions to protect food products from contamination. **SPECTRUM BUN DRAWERS** come in handy as a sanitary holding area for plenty of buns, ready-to-serve.

Both the sneeze guards and bun drawers are NSF listed and fit perfectly with the Spectrum RollsRight™ Commercial Roller Grills. They're perfect for convenience stores, concession stands, cafeterias and more. Warranty and national onsite service program information can be found in the user manual.

- ◆ SNEEZE GUARDS increase sanitation and protect food from airborne contaminants
- ◆ Durable, protective panels allow customers a direct view of options
- ◆ BUN DRAWERS add convenience and save space on the countertop
- ◆ Provides a sanitary holding area for hot dog buns
- ◆ One year warranty

ITEM	DESCRIPTION	UOM
EHD-30-SG	Sneeze Guard to fit EHD-30NS Hot Dog Roller	Each
EHD-30-SGD	Sneeze Guard w/Hinged Door to fit EHD-30NS	Each
EHD-30-BD	Bun Drawer to fit EHD-30NS Hot Dog Roller	Each
EHD-50-SG	Sneeze Guard to fit EHD-50NS Hot Dog Roller	Each
EHD-50-SGD	Sneeze Guard w/Hinged Door to fit EHD-50NS	Each
EHD-50-BD	Bun Drawer to fit EHD-50NS Hot Dog Roller	Each

Products count for 100% of their net price value, towards free freight program.



# ELECTRIC COUNTERTOP CONVEYOR TOASTER



ECT-500 back view

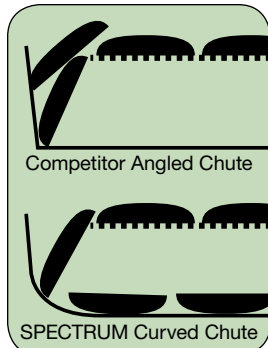

The curved return chute prevents larger food items from getting caught up.



ECT-500

MODEL	SLICES PER HOUR	VOLTAGE	POWER (W)	AMPS	DIMENSIONS (INCHES)			LBS
					WIDTH	DEPTH	HEIGHT	
ECT-500	500	208/240 V	2000/2600	9.6/10.8	14.6"	17"	15"	39.57

Dimensions do not include accessory pieces.



The **SPECTRUM CONVEYOR TOASTER** is perfect for high volume serving of bagels, toast, small pizzas and similar dough based products that need fast and consistent toasting. The conveyor toaster is easy to operate and the belt speed setting control allows for perfect doneness. The Spectrum Conveyor Toaster can utilize top and bottom heating elements simultaneously or independently. The specially designed product return ramp is extra wide for toasting oversized bagels. The conveyor toaster has front product return as well as optional rear product return. The Spectrum Conveyor Toaster is NSF, CUL and UL approved.

- ◆ Toaster makes up to 500 slices per hour
- ◆ Rounded return chute allows for extra-large bagels
- ◆ Infinite speed doneness control
- ◆ Independent 3-position heating element selector
- ◆ Multiple power and speed ("Doneness") settings to get the perfect toast
- ◆ Adjustable feet
- ◆ UL listed for compliance with UL-197
- ◆ NSF listed for compliance with NSF-4
- ◆ One year parts and labor warranty

ITEM	DESCRIPTION	UOM
ECT-500	Electric Conveyor Toaster	Set

# ELECTRIC COUNTERTOP GRIDDLES



EGD-36





EGD-24

MODEL	VOLTAGE	POWER (W)	AMPS	DIMENSIONS (INCHES)			TEMPERATURES		LBS
				WIDTH	DEPTH	HEIGHT	°C	°F	
EGD-24	208/240 V	4200/5600W	20.2/23.4A	24"	21.7"	12.9"	65°-250°C	150°-480°F	92.92
EGD-36	208/240 V	6300/8400W	30/35A	36"	21.8"	12.9"	65°-250°C	150°-480°F	123.13



**SPECTRUM ELECTRIC GRIDDLES** feature a 1/2" polished steel grill surface with extra tall steel surround wall enclosures. The electric griddles have independent zone controlled heating that allow the operator to use any variety of heat settings from maximum grilling temperature to low warming and holding temperature. Spectrum Electric Griddles are NSF, CUL and UL approved. Warranty and national service program information can be found in the user manual.

- ◆ EGD-24: Two independently controlled heat zones, 24"W x 16-1/2"D grilling surface
- ◆ EGD-36: Three independently controlled heat zones, 36"W x 16-1/2"D grilling surface
- ◆ Stainless steel body and catch tray
- ◆ Stainless steel side and rear backsplash for food containment
- ◆ Solid steel plate with a 1/2" thickness on both EGD-24 and EGD-36
- ◆ EGD-24 supplied with a plug and lead (NEMA L6-30P) for quick installation/connection
- ◆ Adjustable feet
- ◆ UL listed for compliance with UL-197
- ◆ NSF listed for compliance with NSF-4
- ◆ One year parts and labor warranty

ITEM	DESCRIPTION	UOM
 EGD-24	Electric Griddle, 24", 240 Volts, with Plug and Lead	Set
 EGD-36	Electric Griddle, 36", 240 Volts	Set
EHD-P12	Replacement Knob for EGD-24 & EGD-36	Each





# GAS COUNTERTOP HOT PLATES



GHP-4



GHP-2



Curved dome over pilot light protects from spills and food debris.



MODEL	# OF BURNERS	BTU/PER NAT/LP	TOTAL BTU/HR	PRESSURE IN. W.C	DIMENSIONS			LBS
					WIDTH	DEPTH	HEIGHT	
GHP-2	2	22,000	44,000	6 / 10	12"	26.75"	15"	58.75
GHP-4	4	22,000	88,000	6 / 10	24"	26.75"	15"	103.95

Note: Depths do not include gas inlet pipe, located at rear of the unit.



**SPECTRUM GAS HOT PLATES** come equipped with precision engineered manually controlled valves. The gas hot plates have dual pilot light assemblies that have individual gas feed lines to allow instant restarting if one pilot light goes out. Pilot lights are located away from the center of the burners and are covered under our specially designed burner trivets to keep them away from cooking debris. Spectrum Gas Hot Plates come with LP conversion kits and are ETL approved for sanitation and ANSI Z83.11 for U.S. and CSA 1.8b for Canada. Warranty and national onsite service program information can be found in the user manual.

- ◆ GHP-2: Two independently controlled burners
- ◆ GHP-4: Four independently controlled burners
- ◆ Stainless steel body, drip tray, and back splash
- ◆ Removable cast iron grills for easy cleaning
- ◆ Conversion kit allows the use of propane or natural gas
- ◆ Adjustable pilot light
- ◆ Adjustable feet
- ◆ ETL listed for safety and sanitation
- ◆ One year parts and labor warranty

ITEM	DESCRIPTION	UOM
 GHP-2	Gas 2 Open Burner Hot Plate & 1 Conversion Kit	Set
 GHP-4	Gas 4 Open Burner Hot Plate & 1 Conversion Kit	Set
GHP-P12	Replacement Knob for GHP-2 & GHP-4	Each



# GAS COUNTERTOP GRIDDLES



GGD-36M



GGD-24M



MODEL	# OF BURNERS	BTU/PER NAT/LP	TOTAL BTU/HR	PRESSURE IN. W.C	DIMENSIONS			GRILL SURFACE		LBS
					WIDTH	DEPTH	HEIGHT	WIDTH	DEPTH	
GGD-24M	2	30,000	60,000	6 / 10	24"	29.625"	15.6"	24"	20"	157.85
GGD-36M	3	30,000	90,000	6 / 10	36"	29.625"	15.6"	36"	20"	228.29

Note: Depths do not include gas inlet pipe, located at rear of the unit.



**SPECTRUM GAS GRIDDLES** come equipped with precision engineered manually controlled valves. All gas griddles have a 3/4" polished steel cook plate and full length 3" wide front rail for keeping spillage to a minimum. Spectrum Gas Griddles come with LP conversion kits and are ETL approved for sanitation and ANSI z83.11 for U.S. and CSA 1.8b for Canada. Warranty and national onsite service program information can be found in the user manual.

- ◆ GGD-24M: Two independently controlled heat zones, 24"W x 20"D grilling surface
- ◆ GGD-36M: Three independently controlled heat zones, 36"W x 20"D grilling surface
- ◆ Stainless steel body, sides, rear back splash, and catch tray
- ◆ Solid steel plate with a 3/4" thickness on both GGD-24M and GGD-36M
- ◆ Conversion kit allows the use of propane or natural gas
- ◆ Adjustable pilot light
- ◆ Adjustable feet
- ◆ ETL listed for safety and sanitation
- ◆ One year parts and labor warranty

ITEM	DESCRIPTION	UOM
 GGD-24M	Gas Griddle / Manual Controls & 1 Conversion Kit	Set
 GGD-36M	Gas Griddle / Manual Controls & 1 Conversion Kit	Set
GHP-P12	Replacement Knob GGD-24M & GGD-36M	Each



Conforms to ANSI STD  
Z83.11b-2009(R2012)  
Certified to CSA  
STD 1.8b-2009(R2012)



# GAS COUNTERTOP CHARBROILERS



GCB-36R



Plates can sit on an angle or flat for proper drainage.



Grooves direct excess oils into tray to prevent oil build up.



GCB-24R

MODEL	# OF BURNERS	BTU/PER NAT/LP	TOTAL BTU/HR	PRESSURE IN. W.C	DIMENSIONS			GRILL SURFACE		LBS
					WIDTH	DEPTH	HEIGHT	WIDTH	DEPTH	
GCB-24R	2	40,000	80,000	6 / 10	24"	27"	15.6"	24"	20"	142.31
GCB-36R	3	40,000	120,000	6 / 10	36"	27"	15.6"	36"	20"	209.22

Note: Depths do not include gas inlet pipe, located at rear of the unit.



**SPECTRUM GAS RADIANT CHARBROILERS** come equipped with precision engineered manually controlled valves. All radiant grill grids are designed to be reversible. Cooking can be done with grids leveled or reversed and placed into an angled position. Specially designed channels in the grids allow for excess cooking residue to travel easily into the grease pan. Spectrum Radiant Charbroilers come with LP conversion kits and are ETL approved for sanitation and ANSI Z83.11b for U.S. and CSA 1.8B for Canada. Warranty and national onsite service program information can be found in the user manual.

- ◆ GCB-24R: Two independently controlled burners, 24"W x 19"D grilling surface
- ◆ GCB-36R: Three independently controlled burners, 36"W x 19"D grilling surface
- ◆ Stainless steel body, drip tray, side and back splashes
- ◆ Removable cast iron grills and stainless steel baffles for easy cleaning
- ◆ Conversion kit allows the use of propane or natural gas
- ◆ Adjustable pilot light
- ◆ Adjustable feet
- ◆ Lava rock kits also available
- ◆ ETL listed for safety and sanitation
- ◆ One year parts and labor warranty

ITEM	DESCRIPTION	UOM
GCB-24R	Gas Broiler / Radiant & 1 Conversion Kit	Set
GCB-36R	Gas Broiler / Radiant & 1 Conversion Kit	Set
GCB-LRRC	Lava Rock Kit	Each
GHP-P12	Replacement Knob for GCB-24R & GCB-36R	Each



Conforms to ANSI STD Z83.11b-2009(R2012)  
Certified to CSA STD 1.8b-2009(R2012)



DINNERWARE	18
FLATWARE	41
BUFFET SERVICE	64
TABLETOP	77
DINING SERVICE	94
BEVERAGE SERVICE	114

DISPLAY	124
BAR SUPPLIES	129
PRO. CUTLERY	146
PRO. COOKWARE	165
STEAM TABLE PANS	186
POLY PANS/STORAGE	192

BAKEWARE	200
PIZZA SUPPLIES	223
FOOD PREP	232
KITCHEN UTENSILS	251
APPAREL	290
JANITORIAL	295

SHELVING & RACKS	309
BUSSING/TRANSPORT	313
COUNTERTOP EQUIPMENT	321
<b>SPECTRUM</b>	337

**Index by ITEM NUMBER**  
Red indicates NEW item

**0-9**

0001	61
0002	61
0004	60
0005	55
0006	54
0007	56
0008	57
0010	56
0012	61
0014	61
0015	55, 62
0016	57
0019	58
0021	54
0024	60
0025	59
0026	58
0030	46, 54, 62, 74
0031	47
0033	53
0034	51, 62
0035	52
0036	50
0037	49
0039	48
0081	60
0082	60
201	67
202	67
203	67
207	69
211	69
508	67
601	66
602	66
603	66
708	67
901	71, 114
902	71, 114
101A	64
101B	64
103A	64
103B	64
108A	65
308A	65
408-1	67
903A	70, 114
903B	70, 114
905A	70, 114
905B	70, 114

**A**

AAD	283
AASP	206
ABBC	318
ABP	205
ACN	126
ACP	204, 207
ACS	163
ACSD	106, 129
ACTD	106
ADB	127, 188-189
ADBC	289
ADC	126
ADD	215, 230
ADO	84
ADP	191
ADRG	217, 227
ADRK	312
AES	285
AFD	306
AFP	177, 181, 252
AFPI	176
AGP	182
AHC	289
AICD	260

ALB	180
ALBC	318
ALBH	180
ALBP	181
ALD	261
ALDB	183
ALDP	214, 228
ALHP	180
ALO	243
ALPC	180
ALRC	202, 203, 314, 315, 318
ALRK	202, 203, 314, 315
ALRP	181
ALSB	183
ALSP	184
ALST	180
ALXP	101, 181, 200
ALZK	203, 315
AM	222, 271
AMF	208
AMS	225
AMT	286
AP	116, 241
APCD	216, 250
APHS	230
APL	84
APM	207
APP	226, 288
APPL	207
APRK	117
APS	183
APSK	116
APSP	116
APZC	223
APZK	223
APZN	223
APZP	224
APZS	225
APZT	223, 225
ARP	215, 229
AS	280
ASDR	312
ASET	180
ASFB	280
ASFP	182
ASFT	91, 104, 125
ASP	176, 182
ASS	276
AST	126
ATC	105
ATCH	95
AWRK	202, 314
AWZK	203, 315
AXAP	179
AXBZ	179
AXHA	178
AXHB	178
AXHH	178
AXPE	201
AXS	176, 178-180
AXSI	176
AXST	179
AXTI	176

**B**

BA	292, 293
BAM	191
BAMC	191
BAMIN	190, 256
BC	129
BCH	133
BCS	89
BFM	252
BGDV	109, 231, 319
BGPZ	109, 231, 319
BHKF	263
BHKP	263
BHKS	263
BHON	259
BHOP	263
BHPN	259

BHPP	263
BHSN	259
BHSP	263
BL	130, 143
BLS	131
BM	143
BML	143
BPS	131
BR-10, -21, -27, -30	231, 304
BR-15	307
BR-24, -28	303
BR-25	122, 303
BR-319, -500	305
BR-36W, -60W	231, 300, 304
BR-7B, -7S	305
BR-9, -12, -31	304
BRF	300
BRM	109, 300
BRN	303
BRP	303
BS	120, 130
BSFK	263
BSOB	263
BSON	259
BSOT	263
BSPB	263
BSPN	259
BSPT	263
BSSB	263
BSSN	259
BSST	263
BST	131
BTGP	144, 302
BTH	144, 302
BTM	144, 302
BTW	144, 302
BW	74
BXC	301

**C**

C-1080	68
C-2080B	68
C-2F, -3F	69
C-3080B	68
C-4080	68
C-5080	66
CAST	175
CB	248
CBBN	249
CBBU	249
CBEL	105
CBF	248, 249
CBGR	249
CBH	248
CBI	248
CBN	247, 251
CBPP	249, 251
CBR	249, 303
CBRD	249
CBS	137
CBST	249
CBWT	132, 248
CBXH	248
CBYL	249
CC	212
CCB	275
CCH	129
CCK	108
CCM	323
CCOD	243
CCP	206
CCS	275
CD	122
CDB	122, 303
C-DCF, -DCH	188
CDIC	123
CDP	129
C-DP1, -DP2	126, 193
C-DPF1, -DPF2	126, 193
C-DPFH	126, 193
CDR	123

CDT	211
CDTC	211
CEP	173
CF	119
C-F1	64-69
C-F2, -F4, -F6	69
CGS	111
CGSF	111
CH	292
CHB	110
C-HDC, -HFC1	188
CHH	110
CHK	105
CJ	90
CKM	204
CKS	126, 210
CKSR	210
CL	107
CLO	123
CLR	107
CLSO	123
CMF	208
CMM	81, 130
CMT	73, 99
CO	133, 236
COD	243
CODS	275
CPSF	206
C-RCF	127, 188
CRD	324
CRK	125, 198
CRKC	125, 198
C-RTC	66
CS	105, 163, 209, 284
CSF	298
CSFP	174
CSP	122
CSPP	79, 174
CST	212
CSW	79
CT	316
C-WPF, -WPP	66-68, 187
C-WPF6, -WPP	187
CXP	201

**D**

DB	209
DCA	313
DCCR	77
DCFP	77
DCH	292
DCL	77
DCSC	77
DCSP	77
DCWA	78
DCWB	78
DCWC	78
DCWD	78
DCWE	78
DDSA	81
DDSB	79
DDSC	78
DDSD	81
DDSE	81, 130
DDSF	106
DDSG	89
DDSH	82
DDSI	82
DLR	297
DM	299
DP	109, 300
DRG	217, 227
DSC	214, 229, 251
DT	71, 118
DWAB	124
DWCC	97, 141
DWR	199, 228, 296, 316

**E**

ECO	332
ECT	342





ECW	122, 326
EDM	325
EFS	330
EFT	330
EGD	343
EGR	289
EGRS	289
EHD	340-341
EHL	329
EIC	332
EMW	338-339
EPG	331
EPO	333
ESG	330
ESH	328
ESW	336
EWP	69, 333

<b>F</b>	
FAUCET	70, 114
FB	185
FBM	80
FBR	184
FBRs	184
FC	109, 313
FCS	240
FCW	136, 198, 297
FF	185, 289
FFB	185, 289
FFC	236
FFT	100, 200
FGMT	127
FGT	100
FGTT	100
FMC	295
FN	266
FPCM	81, 122
FPP	252, 261
FPPN	258
FPS	252, 261
FPSN	258
FQP	207
FS	84, 175, 289
FSC	298, 300
FSP	287
FSS	298
FST	160, 272
FSW	109, 300
FVS	233
FW	327
FWS	233

<b>G</b>	
G	86-87
GBH	305
GBK	305
GBS	89
GCB	346
GCR	157
GGD	345
GH	143
GHC	143
GHP	344-346
GHT	120
GLC	108, 293, 301
GLP	301
GOB	86
GP	285
GR	131
GRTS	103, 163, 282
GS	120
GSH	305
GSN	305
GT	103, 282
GTP	120
GWB	144, 303

<b>H</b>	
HAC	207, 224
HAG	175
HCD	234
HDH	175
HDM	325
HFC	232
HFS	308
HHP100S	192
HHP104	192
HHP106	192
HHP10DS	192
HHP200S	192
HHP204	192

HHP206	192
HHP20DS	192
HHP300S	192
HHP304	192
HHP306	192
HHP30DS	192
HHP400S	192
HHP404	192
HHP406	192
HHP40DS	192
HHP600S	192
HHP604	192
HHP606	192
HHP60DS	192
HLF	204, 208
HP	286
HPO	72, 124
HPR	72, 124
HPS	72, 124
HRCPP	204
HRS	72, 124
HSCP	204
HSP	206
HTS	111

<b>I</b>	
IB	197, 319
ICB	141
ICC	88
ICCP	135
ICCT	135
ICD	252, 260
ICH	135
ICOP	260
ICP	136
ICR	209
ICS	260
ICT	75, 135, 265
IFPC	320
IFT	320
IGD	175
IGL	175
IIC	136, 319
INS	69, 191
INSC	69, 190-191, 256
INSH	69, 191, 336
INSN	190, 256
IS	280
ISP	84, 175
ISS	260
IT	75, 135, 265

<b>J</b>	
J	131
JB2920	120
JB2932	120
JC	132, 241, 283
JST	131

<b>K</b>	
K-12S thru -54S	155
K-35W thru -438W	63, 164
K-40P	158
K-4G	155
K-50P thru -85P	63, 164
KB	63, 164
KBG	159
KBP	159
KC	158
KCC	162
KCL	162, 287
KCP	163
KCS	103, 163
KDB	79
KFP	146-149, 155, 158, 288
KGD	156
KPF	158, 288
KPP	162, 226
KR	158
KS	157, 284
KSP	156
KWP	150-154, 253, 266

<b>L</b>	
LC	104, 285, 287
LDC	252, 261
LDCN	257
LDI	261
LDIN	257
LDS	261

LDT	261
LE	74
LED	111
LMD	94
LMF	94
LMS	94
LMTD	94
LMTT	94
LS	132, 283

<b>M</b>	
MAS	107, 144
MB	113, 128, 283
MBAF	113, 128
MBB	113, 128
MBBE	113, 128
MBM	113, 128
MBPM	113, 128
MCP	130, 222, 271
MCPP	222, 270
MDL	239
MH	73, 96
MHH	300
MMB	38-39
MMPO	38
MMPR	38
MMPT	38
MMSC	39
MMU	39
MOP	299
MOPH	299
MPB	298
MPD	221, 228, 268
MPF	184, 274
MPN	184, 274
MPS	132, 241
MS2K	131, 217, 277
MS3A	277
MSB	277
MSH	277
MSL	222, 270
MSP	222, 270
MSPD	222, 270
MSPP	222, 270
MSS	276
MST	277
MSTF	277
MT	286
MWP	266
MXB	242
MXBH	242
MXBS	242
MXBT	242
MXHV	242
MXRU	242

<b>N</b>	
NACP	206
NB	218
NC	267
NH	106
NLG	301
NLGH	301
NPM	237
NS	221, 268
NSP	221, 268
NTHM	206

<b>O</b>	
OC	278
ODR	105
OGZ	109, 313
OM	218
OMF	219
OMS	219
OMT	219
OP	144, 308
OPL	84, 99
OS	235

<b>P</b>	
PBB	91, 125
PBC	211
PBD	115
PBDW	115, 198
PBM	132
PBST	218, 278
PC	137
PCB	109, 313
PCM	207
PCRC	195

PCSC	194
PDG	217, 227
PDS	214, 229, 251
PDT	121
PECC	194, 252
PESC	194
PF	216, 278, 308
PFB	93, 101
PFBT	139
PFFV	196
PFFW	196
PFSF	196
PFSH	196
PGS	333
PGW	189, 201
PGWS	189, 201
PH	172, 181, 219
PK	102, 129
PKT	139
PKTS	88, 102, 237
PL	109, 199, 214, 228, 313, 317
PLB	93, 101
PLD	76, 264
PLK	284
PLP	317
PLSP	238
PLTC	317
PLW	317
PMB	158
PMC	95
PMCD	95
PMCF	95
PMCP	221, 271
PMCT	95
PMG	157, 287
PMP	85
PMSB	85
PMU	221, 271
PN	266
POA	284, 308
POB	93, 101
POP	323
PP	137-138
PPA	138
PPB	139
PPC	162, 215, 226
PPG	225
PPH	89
PPL	302
PPM	105, 137
PPR	138
PPRC	195
PPT	76, 264
PR	87, 266
PRTS	103, 163, 282
PS	280
PSB	102, 279
PSBW	91, 125
PSC	220, 269
PSD	220, 269
PSG	220, 269
PSGE	220, 269
PSH	220, 251, 269
PSM	286
PSN	88
PSR	302
PSS	76, 264
PSSB	76, 264
PST	215
PSTCO	215
PSUD	89, 279
PSW	102, 279
PT	75, 265
PTC	296-297
PTCB	296
PTCL	296-297
PTCP	296
PTM	266
PTMP	266
PTOS	75, 265
PTP	121
PTRC	195
PTS	80
PTSC	194
PTSN	121
PTW	85
PUT	76, 264
PUTF	76, 264
PWBK	92, 127
PWBN	92, 127
PWC	162, 226

PZG ..... 227  
PZP ..... 226

**R**

RBM ..... 295  
RBMH ..... 295  
RBMH ..... 295  
RBMH ..... 295  
RC ..... 334  
RD ..... 215, 230  
RFM ..... 39, 88  
RFS ..... 216, 230  
RP ..... 39, 88  
RS ..... 90  
RSB ..... 308  
RVS ..... 105  
RW ..... 335

**S**

SAF ..... 216, 278  
SAP ..... 172  
SAS ..... 107, 144  
SB ..... 219, 267  
SBD ..... 118  
SBF ..... 205  
SBM ..... 132  
SBMW ..... 82  
SBR ..... 90  
SBS ..... 201, 251  
SBW ..... 90, 104  
SC ..... 276  
SCAL ..... 238  
SCB ..... 109, 313  
SCC ..... 283  
SCD ..... 122  
SCF ..... 276  
SCLH ..... 238  
SCPH ..... 106  
SCP ..... 88  
SCR ..... 305  
SCS ..... 276  
SCT ..... 89  
SCU ..... 207  
SD ..... 90, 306  
SDA ..... 287  
SDC ..... 210  
SDP ..... 106, 129  
SES ..... 285  
SF ..... 216, 250, 278, 308  
SFC ..... 80  
SFCW ..... 80  
SFR ..... 91, 104, 125  
SGN ..... 71, 111-112, 118  
SGNB ..... 112  
SHHD ..... 261  
SIK ..... 308  
SIV ..... 216  
SIZ ..... 84  
SK ..... 63, 164  
SKO ..... 286  
SLO ..... 243  
SMB ..... 222, 242  
SMT ..... 101  
SND ..... 90, 104  
SP ..... 83, 302  
SP7-Series ..... 193  
SPB ..... 70, 114  
SPBR ..... 279  
SPC ..... 173, 283  
SPCF ..... 188  
SPCH ..... 188  
SPCN ..... 188  
SPCQ ..... 188  
SPCS ..... 188  
SPCT ..... 188  
SPCTT ..... 188  
SPF1 ..... 186  
SPF2 ..... 64-68, 186, 187  
SPF4 ..... 186  
SPF6 ..... 186  
SPFB ..... 189  
SPFD2 ..... 187  
SPFP2 ..... 187  
SPFP4 ..... 187  
SPFP6 ..... 187  
SPG ..... 302  
SPH1 ..... 186  
SPH2 ..... 186  
SPH4 ..... 186  
SPH6 ..... 186  
SPHP2 ..... 187

SPHP4 ..... 187  
SPHP6 ..... 187  
SPJH ..... 186-187  
SPJL ..... 186-187  
SPJM ..... 186  
SPJP ..... 186  
SPM ..... 213, 254  
SPN2 ..... 186  
SPN4 ..... 186  
SPP ..... 224  
SPQ2 ..... 186  
SPQ4 ..... 186  
SPQ6 ..... 186  
SPR ..... 140  
SPS ..... 255  
SPS2 ..... 186  
SPS4 ..... 186  
SPS6 ..... 186  
SPSCF ..... 188  
SPSCH ..... 188  
SPSCN ..... 188  
SPSCQ ..... 188  
SPSCS ..... 188  
SPSCT ..... 188  
SPSCTT ..... 188  
SPT2 ..... 186  
SPT4 ..... 186  
SPT6 ..... 186  
SPTT2 ..... 186  
SPTT4 ..... 186  
SPTT6 ..... 186  
SQG ..... 282  
SR ..... 335  
SRS ..... 59, 74, 283  
SRT ..... 285  
SS ..... 155  
SSBD ..... 115  
SSC ..... 280  
SSD ..... 217  
SSDB ..... 173  
SSET ..... 171  
SSFP ..... 172  
SSLB ..... 171  
SSOP ..... 172  
SSS ..... 276  
SSSP ..... 171  
SST ..... 171  
SSTC ..... 171 - 173  
ST ..... 75, 265  
STB ..... 120  
STH ..... 75, 265  
STN ..... 250, 288  
STR ..... 209  
STRS ..... 99, 142  
STS ..... 74  
SUC ..... 318  
SVM ..... 240  
SWA ..... 286  
SWS ..... 286  
SWU ..... 84

**T**

T ..... 90  
TB ..... 185  
TBC ..... 108  
TBCO ..... 108  
TBCS ..... 108  
TBH ..... 96  
TBN ..... 96  
TCD ..... 73, 96  
TCHS ..... 80  
TCK ..... 98, 142  
TCT ..... 235  
TD ..... 306-307  
TDS ..... 72, 124  
TDSF ..... 72, 124  
TFG ..... 98, 142  
TGAP ..... 167  
TGBZ ..... 170  
TGET ..... 168  
TGFP ..... 166  
TGSP ..... 169  
TIM ..... 219  
TKP ..... 161, 227, 273  
TKPO ..... 161, 210, 273  
TKPS ..... 161, 210, 273  
TLC ..... 234  
TMT ..... 244-246  
TN165 ..... 160, 272  
TN166 ..... 160, 272  
TN249 ..... 160, 272

TN32 ..... 160, 272  
TN409 ..... 160, 272  
TN43 ..... 160, 272  
TN44 ..... 160, 272  
TN46 ..... 160, 272  
TN48 ..... 160, 272  
TN526 ..... 160, 272  
TN54 ..... 160, 272  
TN56 ..... 160, 272  
TN713 ..... 160, 272  
TN719 ..... 160, 272  
TNH ..... 160, 272  
TNS ..... 160, 210, 272  
TOS ..... 160, 210, 272  
TP ..... 307  
TPC ..... 85, 237  
TR ..... 98  
TRH ..... 98, 142  
TSC ..... 283, 307  
TSY ..... 98  
TT ..... 105  
TTG ..... 255  
TTG5 ..... 287  
TTH ..... 307  
TTS ..... 232  
TW ..... 107  
TWP ..... 154, 161, 253, 273  
TWPO ..... 161, 210, 253, 273  
TWPS ..... 161, 210, 253, 273

**U**

UC ..... 318  
UNF ..... 290-291  
UP ..... 250  
USF ..... 307  
UT ..... 262, 265  
UTLK ..... 265  
UTPH ..... 252, 262  
UTS ..... 265

**V**

VC ..... 310, 312  
VCB ..... 310  
VCCD ..... 309  
VCH ..... 309  
VCS ..... 309  
VEX ..... 311  
VEXB ..... 311  
VEXS ..... 309  
VM ..... 312  
VP ..... 162-163, 226, 281, 285, 287  
VSS ..... 119  
VSW ..... 119  
VTS ..... 240

**W**

W612 ..... 120  
W632 ..... 120  
W670 ..... 120  
WA ..... 108, 293  
WB ..... 97, 140  
WBKG ..... 93  
WBKH ..... 80, 86  
WBR ..... 218  
WBRP ..... 218  
WBS ..... 137  
WC ..... 97, 141  
WCB ..... 82, 103, 248  
WCH ..... 108  
WCS ..... 298  
WDL001 ..... 37  
WDM001 ..... 29  
WDM002 ..... 37  
WDM003 ..... 35  
WDM004 ..... 36  
WDM005 ..... 35  
WDM006 ..... 37  
WDM007 ..... 36  
WDM008 ..... 30  
WDM009 ..... 34  
WDM010 ..... 37  
WDM011 ..... 31  
WDM012 ..... 33  
WDM013 ..... 34  
WDM014 ..... 33  
WDM015 ..... 31  
WDM016 ..... 31  
WDM017 ..... 30  
WDM018 ..... 32  
WDM019 ..... 32  
WDM020 ..... 28

WDP001 ..... 23  
WDP002 ..... 23  
WDP003 ..... 22  
WDP004 ..... 19  
WDP005 ..... 21  
WDP006 ..... 21  
WDP007 ..... 21  
WDP008 ..... 22  
WDP009 ..... 20  
WDP010 ..... 20  
WDP011 ..... 20  
WDP012 ..... 26  
WDP013 ..... 25  
WDP014 ..... 27  
WDP015 ..... 27  
WDP016 ..... 27  
WDP017 ..... 24, 25  
WDP018 ..... 25  
WDP019 ..... 22  
WDP020 ..... 25  
WDP021 ..... 26  
WDP022 ..... 19  
WDP023 ..... 23  
WFB ..... 218  
WG10 ..... 130  
WH ..... 86  
WHW ..... 280, 301  
WKCS ..... 174  
WKR ..... 174  
WLC ..... 207  
WMB ..... 158  
WMW ..... 132  
WOK ..... 174  
WP ..... 122  
WPB ..... 120  
WPC ..... 121  
WPCB ..... 121  
WPCT ..... 121  
WPG ..... 120  
WPIT ..... 121  
WPM ..... 83  
WPMMP ..... 83  
WPP ..... 226  
WPS ..... 121  
WPST ..... 275  
WR ..... 297  
WRP ..... 215, 229  
WS ..... 298  
WSK ..... 286  
WSP ..... 221, 268  
WSS ..... 298  
WWB ..... 91  
WWP ..... 221, 268

**X**

XLB ..... 134, 322

**Z**

Z-AR ..... 45  
Z-AZ ..... 42  
Z-CL ..... 43  
Z-CR ..... 44  
Z-IS ..... 41  
Z-MC ..... 40

DINNERWARE	18
FLATWARE	41
BUFFET SERVICE	64
TABLETOP	77
DINING SERVICE	94
BEVERAGE SERVICE	114

DISPLAY	124
BAR SUPPLIES	129
PRO. CUTLERY	146
PRO. COOKWARE	165
STEAM TABLE PANS	186
POLY PANS/STORAGE	192

BAKEWARE	200
PIZZA SUPPLIES	223
FOOD PREP	232
KITCHEN UTENSILS	251
APPAREL	290
JANITORIAL	295

SHELVING & RACKS	309
BUSSING/TRANSPORT	313
COUNTERTOP EQUIPMENT	321
<b>SPECTRUM</b>	<b>337</b>

**Index by ITEM NAME**

Red indicates **NEW** item

**A**

Adaptor Bars..... 127, 188  
 Adaptor Plates..... 191  
 Air Freshener, Automatic..... 306  
 Airpot Rack..... 117  
 Airpots..... 116  
 Allergen Free..... 194, 252  
 Allergen Line..... 220, 251, 269  
 Allergen-Free Utensils.....  
 214, 220, 252, 253, 273  
 Apple Corer..... 283  
 Apple Peeler..... 241  
 Apron, Full-Length..... 108, 293  
 Apron, Waist..... 108, 293  
 Aprons, Bib..... 292  
 Ashtrays..... 107, 144  
 Au Gratin Dishes..... 84

**B**

Bags, Delivery..... 109, 231, 319  
 Bags, Pizza..... 109, 231, 319  
 Baguette Pan, Alu..... 205  
 Bain Marie Covers..... 190, 191, 256  
 Bain Maries..... 191  
 Bain Maries, S/S..... 191  
 Bain Maries, S/S, NSF..... 190, 256  
 Bake Pans, Aluminum..... 181  
 Bake Pans, Layer Cake..... 204  
 Baking Mats, Silicone..... 201, 251  
 Bar Liners..... 143  
 Bar Shakers..... 130  
 Bar Spoon..... 131  
 Bar Strainer..... 131  
 Basket, Cutlery..... 109, 313  
 Baskets, Bread..... 93  
 Baskets, Fast Food..... 93, 101  
 Baskets, Fruit..... 93  
 Baskets, Oval, Plastic..... 93, 101  
 Baskets, Platter, Plastic..... 93, 101  
 Baskets, Woven, Poly..... 92  
 Baster, Plastic..... 218, 278  
 Basting Forks..... 263  
 Basting Spoons..... 259, 263  
 Batter Dispenser..... 216, 250  
 Beer Layering Spoon..... 131  
 Beer Mug Washer..... 144, 303  
 Beer Pitcher..... 121  
 Bell Pitchers..... 120  
 Beverage Dispensers.....  
 115, 198, 297  
 Bev Dispensers, Insulated..... 118  
 Bev Dispensers, Plastic..... 198, 297  
 Bev Server, Insulated..... 119  
 Beverage Server, S/S..... 120  
 Bin, Cutlery Organizer..... 109, 313  
 Bin, Mini..... 317  
 Bins, Ingredient..... 197, 319  
 Bins, Shelf Ingredient..... 197  
 Blender..... 134, 322  
 Blenders, Pastry..... 215  
 Blini Pan..... 79  
 Booster Seats..... 110  
 Bottle Cap Holder..... 133  
 Bottle Openers..... 133  
 Bottle Stopper..... 137  
 Bottles, Juice Pour..... 139  
 Bottles, Liquor Pour..... 137  
 Bowl, Kady..... 79  
 Bowl, Shell..... 91, 125  
 Bowl, Sugar..... 90  
 Bowls, Angled Display..... 124  
 Bowls, Measuring..... 222, 242

Bowls, Mixing..... 242  
 Bowls, Pebbled..... 91, 125  
 Bowls, Salad..... 91  
 Bowls, Salsa..... 85  
 Box Cutter..... 301  
 Brazier Covers, S/S..... 171  
 Braziers, Alu..... 178  
 Braziers, S/S..... 170, 171  
 Bread Baskets, Wire..... 93  
 Bread Board..... 82, 103, 248  
 Bread Form, Silicone..... 205  
 Broom Organizer..... 300  
 Broom Racks..... 300  
 Brooms..... 109, 300  
 Brush Handle..... 231, 300, 304  
 Brush Head, Floor..... 300  
 Brush, Broiler..... 304  
 Brush, Butcher Block..... 304  
 Brush, Coffee Urn..... 122, 303  
 Brush, Decanter..... 122, 303  
 Brush, Fryer..... 303  
 Brush, Glass..... 144, 303  
 Brush, Grill..... 304  
 Brush, Kettle Valve..... 303  
 Brush, Oven..... 231, 304  
 Brush, Pizza Oven..... 231, 304  
 Brush, Pot..... 303  
 Brush, Toilet..... 307  
 Brush, Utility..... 305  
 Brush, Wire..... 305  
 Brushes, Cutting Board..... 249, 303  
 Brushes, Pastry..... 218  
 Buckets, Cleaning..... 302  
 Buffet Servers..... 74  
 Buffet Spoons, PC..... 76, 264  
 Bulk Knives, Paring..... 154  
 Bulk Knives, Spreader..... 154, 273  
 Bun Drawers..... 341  
 Bus Box Cart..... 318  
 Bus Box Covers..... 317  
 Bus Boxes..... 317  
 Bus Boxes, Divided..... 317  
 Butane Stove..... 333  
 Butter Curler..... 281  
 Butter Spreader..... 279  
 Butter Warmer..... 90, 104

**C**

Cake Markers, Alu..... 207  
 Cake Markers, Plastic..... 207  
 Cake Markers, S/S..... 204  
 Cake Pan, Anodized Alu..... 207  
 Cake Pan, Fluted..... 206  
 Cake Pans, Aluminized Steel..... 204  
 Cake Pans, Angel..... 206  
 Cake Pans, Angel Food..... 206  
 Cake Pans, Springform..... 206  
 Cake Pans, Turk Head Mold..... 206  
 Cake Stand & Cover..... 126, 210  
 Cake Stand, Revolving..... 210  
 Call Bells..... 105  
 Can Openers..... 133  
 Carafe Lid..... 119  
 Carafes..... 119  
 Cart, Lug Box..... 318  
 Cast Iron Skillet..... 175  
 Cast Iron Wok..... 79  
 Caster, Dish Caddy..... 313  
 Caster, Ice Caddy..... 136, 319  
 Caster, Mixing Bowl Stand..... 242  
 Casters..... 316  
 Casters, Dolly..... 297  
 Casters, Food Pan..... 320  
 Casters, Ingredient Bin..... 197, 319  
 Casters, S/S Trolley..... 318

Casters, Sheet Pan Rack.....  
 202, 314, 318  
 Casters, Shelving..... 312  
 Casters, Universal Plate..... 316  
 Caution Signs..... 298  
 Chafer Covers..... 66  
 Chafer Fuel Can..... 69  
 Chafer Stand..... 69  
 Chafers..... 64  
 Chain Signs..... 71, 118  
 Char Broilers, Gas..... 346  
 Check Caddy..... 105  
 Check Holder..... 105  
 Check Spindle..... 105  
 Cheese Board..... 103, 248  
 Cheese Grater, Rotary.....  
 103, 163, 282  
 Cheese Graters.....  
 103, 161, 163, 273, 282  
 Cheese Knives..... 103, 163  
 Cheese Plane..... 163, 281  
 Cheese Slicer..... 163, 284  
 Cheese Slicer, Alu..... 163  
 Cheese Slicer, Countertop..... 235  
 Chef Hats..... 292  
 Chef Jackets..... 291  
 Chef Pants..... 291  
 Chef Shirts..... 290  
 Cherry Corer..... 283  
 Chopper/Dicers..... 234  
 Citrus Squeezers..... 132  
 Cleaning Buckets..... 302  
 Cleavers..... 158  
 Coat Check Tickets..... 108  
 Coat Hangers..... 108  
 Cocktail Picks..... 102, 129  
 Cocktail Shakers..... 130  
 Cocktail Strainer..... 131, 217  
 Coffee Decanters..... 122  
 Coffee Knock Box..... 122  
 Coffee Press, French..... 81, 122  
 Coffee Scoop..... 122  
 Coffee Servers..... 122  
 Coffee Urns..... 70, 114  
 Coffee Warmer, Electric.....  
 122, 326  
 Colanders..... 243  
 Condiment Caddy, Wire..... 86  
 Condiment Dispenser.....  
 88, 102, 237  
 Condiment Holders..... 86  
 Condiment Jar Covers..... 90  
 Condiment Jars..... 90  
 Condiment Organizers..... 129  
 Condiment Servers..... 129  
 Convection Oven..... 332  
 Cookie Cutters..... 212  
 Cookie Sheet..... 209  
 Cooking Tools, Nylon.....  
 221, 267, 268  
 Cookware Set, S/S..... 173  
 Corer, Apple..... 281, 283  
 Corer, Cherry..... 283  
 Corer, Pineapple..... 283  
 Corer, Tomato..... 283  
 Corkscrews..... 133  
 Cotton Candy Machine..... 323  
 Counterfeit Pen..... 105  
 Coupler Set..... 211  
 Cover, Dough Box..... 199, 214, 228  
 Cover, Hamburger..... 289  
 Cover, Liquor Pourer..... 137  
 Covers, Bain Marie..... 190, 191, 256  
 Covers, Bus Box..... 317  
 Covers, Deli Crock..... 125, 198  
 Covers, Dish Box..... 317

Covers, Double Boilers, S/S.....  
 171-173  
 Covers, Food Storage Box, PP..... 196  
 Covers, Food Storage, PC..... 194  
 Covers, Food Storage, PP..... 195  
 Covers, Fry Pans, S/S..... 171, 172  
 Covers, Grill Basting..... 289  
 Covers, High Heat..... 192  
 Covers, Inset..... 69, 190, 191, 256  
 Covers, Mini Bin..... 317  
 Covers, Sauce Pans, Alu..... 176, 182  
 Covers, Sauce Pots, Alu..... 176, 182  
 Covers, Stock Pot, Alu..... 176-180  
 Covers, Stock Pot, S/S..... 171-173  
 Covers, Trash Can..... 296  
 Covers, Wok, S/S..... 174  
 Creamer, Insulated..... 119  
 Creamers, S/S..... 89  
 Crocks, Deli..... 125, 198  
 Cruet, Oil/Vinegar..... 86  
 Culinary Baskets..... 277  
 Cup & Lid Organizers..... 123  
 Cup Dispensers..... 123  
 Cutlery Bin..... 109, 313  
 Cutlery Organizer..... 109, 313  
 Cutter Acces, French Fry..... 232  
 Cutters, French Fry..... 232  
 Cutters, Pizza..... 162, 226  
 Cutting Board..... 132, 248, 249, 251  
 Cutting board with Hook..... 247  
 Cutting Board, Wooden.....  
 82, 103, 248  
 Cutting Mats..... 248, 249  
 Cylinders, Flatware..... 109, 313

**D**

Decanters..... 122  
 Decanters, PC..... 121  
 Decorating Combs..... 210  
 Decorating Tip Set..... 211  
 Decorative Picks..... 102, 129  
 Deep Fryers..... 330  
 Deli Crock Covers..... 125, 198  
 Deli Crocks..... 125, 198  
 Delivery Bags..... 109, 231, 319  
 Dinnerware, Melamine..... 28  
 Dinnerware, Porcelain..... 19  
 Dipper, Alu..... 261  
 Dish Box Cart..... 318  
 Dish Box Covers..... 317  
 Dish Boxes..... 317  
 Dish Boxes, Divided..... 317  
 Dish Caddy..... 313  
 Dish, Ice Cream..... 88  
 Dish, Sherbet..... 90  
 Dishes, Portion Control..... 260  
 Dispenser, Syrup..... 89, 279  
 Dispenser, Toilet Seat Cover..... 307  
 Dispensers, Paper Towel..... 306  
 Dispensers, Toilet Paper..... 307  
 Display Cases, Acrylic..... 126  
 Display Merchandisers..... 325  
 Display Trays, Acrylic..... 126  
 Dividers, Dough..... 215, 230  
 Dollies..... 297  
 Dolly, Food Pan..... 320  
 Dolly, Wire..... 296  
 Double Boilers, Alu..... 183  
 Double Boilers, S/S..... 173  
 Dough Box..... 199, 214, 228  
 Dough Box Cover..... 199, 214, 228  
 Dough Roller Dockers..... 215, 230  
 Dough Scraper, S/S..... 214, 229  
 Dough Scrapers, Plastic..... 214, 229  
 Dough Scrapers, S/S..... 214, 229  
 Doughnut Cutter..... 212



Doughnut Basket.....209  
**Drain Shelves, High Heat** ..... 192  
**Drain Shelves, PC**.....193  
Dredges, Alu.....217, 227  
Dredges, PC.....217, 227  
Dredges, S/S.....217, 227  
Drip Trays.....71, 118  
Dunnage Racks.....312  
Dust Mop.....299  
Dust Pan.....109, 300

**E**

Easels, Marker Board .....113, 128  
Egg Poacher.....173  
Egg Ring, S/S.....289  
Egg separator.....285  
Egg Slicers.....285  
Eraser, Marker Board.....113, 128

**F**

Fajita Servers.....84  
False Bottoms.....189  
Fast Food Baskets.....93, 101  
Fast Food Trays.....100  
Faucet, Bev Dispenser.....115, 198  
Faucet, Coffee Urn.....70, 114  
Faucet, Juice Dispenser.....71, 114  
Filter Cones, Fryer Stand.....185, 289

**Fish Bone Tweezers**.....287  
Fish Scaler, S/S.....287  
Fish Spatula.....160, 272  
Flair Bottle.....139  
Flatware.....41  
Flatware Cylinders.....109, 313  
Floor Mats.....295  
Floor Sweeper.....109, 300  
Food Chopper.....240  
Food Containers.....198, 297  
Food Cooker/Wmr, Full Size.....327  
**Food Cooker/Warmer, Rnd**.....327  
Food Marker.....252  
Food Mill.....240  
Food Pan Carriers, Insulated.....320  
Food Pan Covers, PC.....193  
Food Pan, Divided.....64-66, 187  
Food Pans.....64  
**Food Pans, High Heat** .....192  
**Food Pans, PC**.....193  
Food Portioners.....252  
Food Storage Box Covers, PC 196  
Food Storage Boxes, PC.....196  
Food Storage Boxes, PP.....196  
Food Storage Covers, Rnd, PC. 195  
Food Storage Covers, Rnd, PP. 195  
Food Storage Covers, Sq, PE.....194, 252  
Food Storage Covers, Sq, PE.. 194  
Food Storage, Round, PC.....195  
Food Storage, Round, PP.....195  
Food Storage, Square, PC.....194  
Food Storage, Square, PP.....194  
Food Warmer, Electric Pan.. 69, 333  
Fork, Carving.....148, 288  
Fork, Pot.....74  
Fork, Serving.....74  
Forks, Basting.....263  
**Forks, Forged Cook's**.....148, 288  
Forks, Nylon.....267  
French Fry Bagggers.....185, 289  
French Fry Cutters.....232  
French Fry Holder.....80  
French Press.....81, 122  
Frothing Pitchers.....122  
Fruit Baskets, Wire.....93  
Fruit/Vegetable Slicer.....233  
**Fry Basket Presses**.....185  
**Fry Baskets**.....184, 185  
Fry Baskets, Mini.....80  
Fry Cups.....80  
Fry Pan Sleeves.....181  
Fry Pan, Carbon Steel.....174  
Fry Pan, French Style.....174  
Fry Pans, Alu.....177  
Fry Pans, Induction Ready.....176  
Fry Pans, S/S.....166, 172

Fryer Filter Stand.....185, 289  
Fryer Pans.....184  
Fryer Screen.....289  
Fuel Holder.....64-69  
Funnel Strainers, S/S.....216, 278, 308  
Funnel, Confectionary.....216, 250  
Funnel, S/S.....216, 278, 308  
Funnels, Plastic.....216, 278, 308  
Funnels, Spun Alu.....216, 278  
Fuse, Rice Cooker.....334

**G**

Garlic Press.....285  
Gas Cooker, Portable.....333  
Glass Polishing Towel.....144, 302  
Glass Rimmer.....131  
Glass Teapot.....120  
Glove Box Holder.....301  
Gloves, Cotton, White.....108, 293, 301  
Gloves, Cut Resistant.....157  
Gloves, Latex.....301  
Gloves, Mesh, S/S.....157, 287  
Gloves, PE Textured.....301  
Grapefruit Spoon.....59  
Grater, Box.....282  
Graters.....103, 282  
Gravy Boats.....89  
Gravy Ladle.....74  
**Gray Lug Box, Cover**.....317  
Griddle Holder.....305  
Griddle Screen.....305  
Griddle Screen Holder.....305  
Griddle, Cast Iron.....175  
Griddle, Hard Anodized, Alu...175  
Grids, Electric.....343  
Grids, Gas.....345  
Grill Brick.....305  
**Grill Pan, Cast Iron**.....175  
Grinder.....83  
Grippers, Pizza Pan.....225  
**Gyro Pan**.....182

**H**

Hamburger Press.....286  
Handle Holders.....175  
Handles, Wide Floor.....298, 300  
Hanger, Wine Glass.....143  
Heat Lamp, Electric.....329  
Heat Sink, Pizza.....230  
Herb Shears.....157, 284  
High Chair Strap.....110  
High Chairs.....110  
Holders, Knife.....158  
Holloware, Stainless Steel.....40  
Hood Filters.....308  
Hostess Sign.....111  
Hot Dog Roller Grills.....340  
Hot Plate Burners.....344  
Hottle, Glass.....120

**I**

Ice Buckets.....141  
Ice Caddy, Insulated.....136, 319  
Ice Chipper.....135  
Ice Container.....136  
Ice Cream Cone Holder.....126  
Ice Cream Dippers, Alu.....260  
Ice Cream Dishers.....252, 260  
Ice Cream Spade.....260  
Ice Crusher.....136  
**Ice Cube Trays**.....135  
Ice Pick.....135  
Iced Tea Dispensers.....115  
**Induction Cooker**.....332  
Ingredient Bins.....197, 319  
Inserts, Condiment Holder.....129  
Inset Covers.....69, 190, 191, 256  
Inset Covers, Hinged.....69, 191  
Insets.....69, 191  
Insets, NSF.....190, 256

**J**

Jiggers.....131  
Juice Dispensers.....71, 114  
Juice Pour Bottles.....139

Juice Squeezers.....132, 241  
Juicer, Hand Squeeze.....132, 283

**K**

**KATTEX**.....232-235  
**Knife Bag**.....159  
**Knife Guard**.....156  
Knife Holder, Magnetic.....158  
**Knife Block Set**.....149  
**Knife Kit**.....149, 154  
Knife, Nakiri.....146  
Knife, Peeling.....146  
Knife, Tomato.....146  
Knives, Boning.....146  
Knives, Bread.....148, 253  
Knives, Cheese.....103, 163  
Knives, Chef.....147  
Knives, Chopping.....162  
Knives, Cimeter.....150  
Knives, Cook's.....149, 155, 253  
Knives, Hollow Ground.....147  
Knives, Oyster.....162, 281, 287  
Knives, Paring.....146, 253  
Knives, Pizza.....162, 226  
Knives, Santoku.....146  
Knives, Short Bolster.....147  
Knives, Slicer.....148  
Knives, Steak.....63, 164  
Knives, Utility.....146

**L**

Ladles, One Piece, S/S.....252  
Ladle, Mini.....222, 270  
Ladle, Nylon.....267  
Ladles, Black Hd, NSF.....257  
Ladles, Color-Coded.....261  
Ladles, Color-Coded, NSF.....257  
Ladles, Measuring.....222, 270  
Ladles, One Piece, S/S.....257, 261  
Ladles, PC.....76, 264  
Ladles, Serving.....74  
Ladles, Two Piece, S/S.....261  
LED Signs.....111  
Lettuce Cutter.....234  
Lettuce Knife.....284  
Lids, Dredge, PC.....217, 227  
Lids, Food Container.....136, 197, 198, 297, 319  
**Lids, Trash Can**.....296, 297  
Liquor Pour Bottles.....139  
Liquor Pourers.....139  
Loaf Pans, Aluminized Steel.....204  
**Loan Pan, Mini**.....208  
Lobster Crackers.....104, 287  
Lug Box Cart.....318

**M**

Magnetic Knife Holders.....158  
Malt Cup.....130  
Mandoline Slicers.....239  
Marker Boards.....113, 128  
Markers, Cake.....204  
Markers, Neon.....113, 128  
Masher, Nylon.....267  
Mashers, Potato.....266  
Mats, Bar.....143  
Mats, Carpet Floor.....295  
Mats, Cutting.....248  
Mats, Floor, Rubber.....295  
Mats, Service.....143  
Measured Pourers.....138  
Measures, Alu.....222, 271  
Measuring Bowls, S/S.....222, 242  
Measuring Cups, PC.....221, 271  
Measuring Cups, Plstc.....222, 271  
Measuring Cups, S/S.....222, 271  
Measuring Spoons, S/S.....222, 271  
Meat Tenderizers, Alu.....286  
Melamine Dinnerware.....28  
Melon Baller.....281, 283  
Menu Covers.....94  
Menu Holders.....73, 96  
Microwaves.....338  
Mini Cookware, Copper.....77  
Mini Cookware, S/S.....77  
Mini Loaf Pan.....208

Mini Sereware, S/S.....78  
Mixing Bowl Stand.....242  
Mixing Bowls.....242  
Mixing Glass.....130  
Mixing Paddles, Nylon.....221, 268  
Mixing Paddles, S/S.....221, 228, 268  
Molds, Pastry.....213, 254  
Mop Bucket.....298  
Mop Head.....299  
Mortar & Pestle.....132, 241  
Moscow Mule Mugs.....81, 130  
Mounting Strap, Bar Speed Rail 140  
Muddler, Polycarbonate.....132  
Muddler, Wooden.....132  
Muddlers.....132  
Muffin Pans.....208  
Mugs.....81, 130

**N**

Napkin Dispenser, S/S.....106  
**Nesting Sheet Pan Racks**.....203, 315  
Non-Slip Trays.....98, 142

**O**

Oil Can.....278  
Oil Mop.....218  
Onion Slicers.....235  
Order Racks.....105  
Oven Mitts.....219  
Oven, Convection.....332  
Oven, Pizza.....333  
Overflow Pipes.....144, 308  
Oyster Opener.....162, 287

**P**

Paella Pan.....174  
Pail Opener.....284, 308  
Pail, Double.....302  
Pan Grabber.....181  
Pan, Omelet.....171  
Pancake Dispenser.....216, 250  
**Panini Grills**.....331  
Paper Towel Dispenser.....306  
Pasta Baskets.....184, 274  
Pasta Cooker.....173  
Pasta Maker.....237  
Pastry Bags.....211  
Pastry Blenders.....215  
Pastry Brushes, Nylon.....218  
**Pastry Brush, Silicone**.....219, 267  
Pastry Mold.....213, 254  
Pastry Wheel.....215  
Peeler, Apple.....241  
Peelers.....281  
Peelers, Vegetable.....285  
Peelers, Y.....281  
Pepper Mill, Replacement Knob...83  
Pepper Mills.....83  
Pepper Refiller.....87  
Pestle, Wooden.....275  
Pie Cutters.....207  
Pie Plates.....207  
Pie Servers.....160, 161, 253, 272, 273  
Pineapple Corer.....283  
Pitcher, Beer.....121  
Pitcher, Syrup.....88  
Pitchers, Bell.....120  
Pitchers, Frothing.....122  
Pitchers, PC.....121  
Pitchers, S/S.....120  
Pitchers, Water.....121  
Pizza Bags.....109, 231, 319  
Pizza Cutters.....162, 226  
Pizza Disk.....224  
Pizza Knives.....162, 226  
Pizza Oven.....333  
Pizza Pan Grippers.....225  
Pizza Pans.....223  
Pizza Pans, Sicilian.....224  
Pizza Peels, Alu.....226, 288  
Pizza Peels, Wooden.....226  
Pizza Popper.....226  
Pizza Screens.....225  
Pizza Server.....227  
Pizza Tray Rack.....225





Pizza Tray Stand..... 225  
 Pizza Trays..... 223  
 Plate, Salsa..... 85  
 Plating Spoons..... 255  
 Plating Tongs..... 255  
 Platters, Oval, S/S..... 84, 99  
 Platters, Sizzling..... 84  
 Platters, Underliner..... 84  
 Poly Woven Baskets..... 92  
 Popcorn Maker..... 323  
 Porcelain Dinnerware..... 19  
 Pot Holders..... 219  
 Pot Hook..... 172  
 Pot, Rice Cooker..... 334  
 Potato Ricer..... 266  
 Pourers..... 137, 138  
 Pourers, Flexible..... 138  
 Pourers, Free Flow..... 138  
 Pourers, Metal..... 137  
 Pourers, Screened..... 138  
 Powdered Sugar Strainer..... 131, 217  
 Proofing Pans..... 214, 228  
 Pump Kit..... 139  
 Punch Bowl..... 70, 114

**Q**  
 Quiche Pans..... 207

**R**  
 Rack, Glass Hanger..... 143  
 Rack, Icing/Cooling..... 209  
 Rack, Knife..... 158  
 Racks, Broom..... 300  
 Racks, Cup Dispensing..... 123  
 Racks, Cutting Board..... 248  
 Racks, Mop..... 300  
 Racks, Oil/Vinegar Cruet..... 86  
 Racks, Order..... 105  
 Racks, Seafood Tray... 91, 104, 125  
 Racks, Steamer..... 209  
 Ramekins..... 39, 88  
 Refiller, Salt/Pepper..... 87  
 Refrigerator..... 324  
 Retarding Pans..... 214, 228  
 Rice Cookers..... 334  
 Rice Warmers..... 334, 335  
 Risers, Display..... 72, 124  
 Roasting Pans, Alu..... 181  
 Roll Top Cover..... 188  
 Rolling Pins, Alu..... 215  
 Rolling Pins, French..... 215, 229  
 Rolling Pins, Wooden..... 215, 229  
 Rubber Scrap Block..... 308

**S**  
 Salad Bowls..... 91  
 Salt Refiller..... 87  
 Sandwich Grills..... 330  
 Sandwich Spreaders..... 160, 253, 272  
 Sauce Cups, S/S..... 88  
 Sauce Pans Covers, Alu..... 182  
 Sauce Pans, Alu..... 182  
 Sauce Pans, S/S..... 167, 171  
 Sauce Pots, Alu..... 178  
 Sauté Pans, Alu..... 179, 180  
 Sauté Pans, S/S..... 168, 171  
 Scales..... 238  
 Scoop Holder..... 280  
 Scoop, Coffee..... 122  
 Scoop, Ice..... 280  
 Scoops, Alu..... 280  
 Scoops, Flat Bottom, Alu..... 280  
 Scoops, PC..... 280  
 Scoops, Plastic..... 280  
 Scoops, Utility, S/S..... 280  
 Scouring Pads..... 302  
 Scraper, Pizza Oven..... 231, 304  
 Scrapers, Dough, Plastic..... 214, 229, 251  
 Scrapers, Grill..... 305  
 Scrapers, Plastic..... 220, 269  
 Scrapers, S/S..... 160, 272  
 Scrapers, Silicone..... 220, 251, 269  
 Seafood Pick..... 104, 287  
 Seafood Tray Racks... 91, 104, 125

Seafood Trays..... 91, 104, 125, 287  
 Serrator..... 285  
 Server, Coffee, S/S..... 119  
 Servers, Relish..... 90  
 Serving Boards..... 82  
 Serving Spoons, PC..... 76, 264  
 Shakers, Glass..... 86  
 Sharpening Guide..... 155  
 Sharpening Steel..... 155  
 Sharpening Stones..... 155  
 Shears, Herbs..... 157, 284  
 Shears, Kitchen..... 157, 284  
 Shears, Poultry..... 157, 284  
 Sheet Pan Covers..... 201  
 Sheet Pan Extenders..... 201  
 Sheet Pan Grates..... 127, 188  
 Sheet Pan Racks..... 202, 314  
 Sheet Pan Racks, Nesting..... 203, 315  
 Sheet Pans, Alu..... 101, 181, 200  
 Sheet Trays, Plastic..... 200  
 Shelf Ingredient Bins..... 197  
 Shelves, Wire, Chrome Plated... 310  
 Shelves, Wire, Epoxy Coated... 311  
 Shelving Mats..... 312  
 Shelving Sets, Wire, Chrome Plated..... 309  
 Shelving Sets, Wire, Epoxy Coated..... 309  
 Shelving, Accessories..... 310  
 Shelving, Brackets..... 310  
 Shelving, Extend Handle..... 309  
 Short Handle Ladles..... 261  
 Shrimp Deveiner..... 287  
 Sieves..... 216  
 Sifter..... 216, 230  
 Signs, Braille..... 112  
 Signs, Caution Floor..... 298  
 Signs, Information..... 112  
 Signs, Information, 3" x 9"..... 112  
 Signs, Information, 6" x 9"..... 112  
 Signs, Stanchion Frame..... 111  
 Signs, Wet Floor..... 298  
 Silicone Brush..... 219, 267  
 Sink Strainer..... 308  
 Sizzle Platters Set..... 84  
 Skewers, Bamboo..... 286  
 Skewers, S/S..... 286  
 Skimmer, Nylon..... 267  
 Skimmers..... 275  
 Snail Service..... 90, 104  
 Sneez Guards..... 341  
 Soap Dispenser..... 306  
 Soup Warmer, Electric..... 336  
 Soup Warmers, S/S..... 69  
 Spaghetti Servers..... 74  
 Spaghetti Tongs..... 76, 264  
 Spatulas..... 160, 161, 210, 253, 273  
 Spatulas, Bakery..... 160, 161, 210, 272, 273  
 Spatulas, Fish..... 160, 253, 272  
 Spatulas, Grill..... 160, 161, 272, 273  
 Spatulas, Nylon..... 267  
 Spatulas, Offset..... 160, 161, 210, 272, 273  
 Spatulas, S/S..... 161, 273  
 Spectrum..... 338, 340-346  
 Speed Rails..... 140  
 Spillage Pans..... 187  
 Sponge, S/S..... 302  
 Spoon, Wooden..... 221, 268  
 Spoons, Basting..... 259, 263  
 Spoons, Buffet, PC..... 76, 264  
 Spoons, Nylon..... 221, 267, 268  
 Spoons, Serving..... 74  
 Spoons, Serving, PC..... 76, 264  
 Spoons, Serving, S/S..... 74  
 Spoons, Stirring..... 221, 268  
 Spray Bottle..... 302  
 Springform Pans, Anodized, Alu..... 206  
 Squeegees..... 298  
 Squeeze Bottles..... 102, 279  
 Stainless Steel Holloware..... 40  
 Stanchion Frame Signs..... 111  
 Stanchion Posts..... 111  
 Stanchion Signs..... 111

Stand, Mixing Bowl..... 242  
 Stand, Wine Bucket..... 97, 14  
 Steak Knives..... 63, 164  
 Steak Markers..... 286  
 Steak Markers, Allergen-Free..... 252  
 Steak Platter..... 84, 175  
 Steak Weights..... 286  
 Steam Pan Cover..... 188  
 Steam Table Pan Covers..... 187  
 Steam Table Pans, Anti-jamming..... 186  
 Steam Table Pans, GN..... 186  
 Steam Table Pans, Half Long..... 187  
 Steam Table Pans, Handles..... 68, 187  
 Steam Table Pans, Perforated... 187  
 Steam Table Pans, Straight-Sided..... 64-68, 186  
 Steamer Baskets..... 183  
 Steamer Racks..... 209  
 Stir Fry Pans..... 182  
 Stirring Paddles..... 221, 268  
 Stirring Spoons..... 221, 268  
 Stock Pot Covers, Alu..... 176-180  
 Stock Pots, Alu..... 178  
 Stock Pots, Induction Ready... 176  
 Stock Pots, S/S..... 169, 171  
 Strainer, Julep..... 131  
 Strainers, Bouillon..... 275  
 Strainers, China Cap..... 275  
 Strainers, Mesh, S/S..... 276  
 Strainers, Mesh, Tin..... 277  
 Strainers, Spaghetti..... 276  
 Straw Dispenser..... 106, 129  
 Strip Heater, Freestanding..... 328  
 Strip Heater, Undermount..... 328  
 Stripe Herringbone Towel..... 144, 302  
 Sugar Bowl, S/S..... 90  
 Sugar Dispenser, S/S..... 217  
 Sugar Packet Holders, Plastic..... 89

**T**  
 Table Cloth Clip..... 108  
 Table Cloths..... 108  
 Table Crumbers, Alu..... 105  
 Table Number Holders..... 96  
 Table Numbers, Plastic..... 96  
 Table Sign Clips..... 73, 96  
 Table Sign Holders..... 73, 96  
 Table Sign Holders, Acrylic..... 95  
 Table Wedge..... 107  
 Taco Basket..... 185  
 Taco Holders, S/S..... 80  
 Taco Salad Bowls..... 185  
 Taco Server..... 80  
 Tea Ball Infuser..... 120  
 Tea Light..... 107  
 Tea Lights, Rechargeable..... 107  
 Tea Pot, Gooseneck..... 120  
 Teapot, Glass..... 120  
 Teller Sign..... 111  
 Tent Signs..... 71, 118  
 Thermometer, Frothing..... 244  
 Thermometer, Grill..... 245  
 Thermometer, Instant-Read... 244  
 Thermometers, Deep Fryer... 245  
 Thermometers, Digital..... 245  
 Thermometers, Digital, Waterproof..... 246  
 Thermometers, Meat..... 244  
 Thermometers, Oven..... 244  
 Thermometers, Pocket Test... 244  
 Thermometers, Refrigerator/Freezer..... 245  
 Tiered Display Servers..... 72, 124  
 Timers..... 219  
 Tip Tray..... 105  
 Toaster..... 342  
 Toilet Paper Dispensers..... 307  
 Toilet Plunger..... 307  
 Toilet Seat Covers..... 307  
 Toilet Tissue Holders..... 307  
 Tomato Corer..... 281  
 Tomato Slicers..... 232  
 Tongs, Flat, PC..... 76, 264

Tongs, Ice..... 75, 135, 265  
 Tongs, Pastry..... 75, 265  
 Tongs, Pizza..... 227  
 Tongs, Pom..... 75, 265  
 Tongs, Salad..... 75, 265  
 Tongs, Scissor..... 75, 265  
 Tongs, Spaghetti, PC..... 76, 264  
 Tongs, Spaghetti, S/S..... 75, 265  
 Tongs, Tweezer..... 255  
 Tongs, Utility S/S... 75, 252, 262, 265  
 Tongs, Utility, PC..... 76, 264  
 Toothpick Dispenser..... 106  
 Tortilla Press..... 85, 237  
 Tortilla Warmer..... 85  
 Tostada Basket..... 185  
 Towels..... 144, 302  
 Towels, Cleaning..... 144, 302  
 Trash Can..... 296, 297  
 Tray Stand..... 98  
 Tray, Fiberglass, Trapezoid..... 100  
 Tray, Non-Slip Fiberglass..... 98, 142  
 Trays, Cork..... 98, 142  
 Trays, Display, S/S..... 72, 124  
 Trays, Fiberglass, Market..... 127  
 Trays, Fiberglass, Rectangular 100  
 Trays, Mess..... 101  
 Trays, Rubber-Lined Easy Hold..... 98, 142  
 Trays, Seafood..... 91, 104, 125  
 Trays, Serving, Chrome Plated..... 73, 99  
 Trays, Serving, S/S..... 99, 142  
 TRI-GEN™ Cookware..... 166-170  
 Trolley, S/S..... 318  
 Tumblers..... 121  
 Turner, Pancake..... 250, 288  
 Turners..... 160, 161, 253, 272, 273  
 Turners, Cutting Edge..... 160, 272  
 Turners, Serving..... 288  
 Turning Slicer..... 240  
 Tweezers, Fish Bone..... 287

**U**  
 Underliners..... 84  
 Underliners, Platter..... 84  
 Urinal Screen..... 307  
 Utility Cart Accessories..... 318  
 Utility Carts..... 318  
 Utility Pan..... 250

**W**  
 Wall Bracket, Stanchion..... 111  
 Waste Receptacle..... 297  
 Water Pans..... 64-68, 187  
 Water Pitchers..... 121  
 Water Pitchers, Plastic..... 121  
 Wheel, Mop Bucket..... 298  
 Whip, Kettle..... 266  
 Whip, Mayonnaise..... 266  
 Whips, French..... 266  
 Whips, Piano..... 266  
 Whisk, Nylon..... 267  
 Window Squeegee..... 298  
 Wine Buckets..... 97, 141  
 Wine Coaster..... 97, 141  
 Wine Cooler..... 97, 141  
 Wiper Bracket Mount..... 301  
 Wire Cake Leveler..... 207  
 Wire Cart..... 309  
 Wire Cart, Trash Can..... 296  
 Wire Pan Grates..... 127, 188, 201  
 Wok Covers, S/S..... 174  
 Wok Stand..... 174  
 Woks..... 174  
 Wood Block Set, Knives..... 149  
 Wringer, Mop Bucket..... 298

**Z**  
 Zester..... 281

## LIMITED WARRANTY ~ ELECTRIC AND GAS EQUIPMENT



WINCO®/DWL Industries Co. warrants to the original purchaser of new electrical and gas equipment of our manufacture, when installed properly within USA and Canada, and subjected to normal use, is free from defects in material or workmanship for a period of one (1) year. Coverage for customers outside of the USA and Canada will be for parts only.

Determination of repair or replacement will be at the sole discretion of Winco.

**EXCLUSIONS:** Light bulbs, blades or coatings are not covered under said warranty. The labor warranty is one (1) year from original purchase date from dealer, or 18 months from Winco shipment date, whichever date occurs first.

**WINCO'S OBLIGATION AND LIABILITY UNDER THIS WARRANTY IS EXPRESSLY LIMITED TO REPAIRING AND REPLACING EQUIPMENT THAT PROVES TO BE DEFECTIVE IN MATERIAL OR WORKMANSHIP, WITHIN THE APPLICABLE WARRANTY PERIOD.**

**IN NO EVENT SHALL WINCO BE LIABLE FOR INCIDENTAL OR CONSEQUENTIAL DAMAGES TO BUYER OR ANY THIRD PARTY, INCLUDING AND WITHOUT LIMITATION: LOSS OF PROPERTY, PERSONAL INJURY, LOSS OF BUSINESS OR PROFITS, OTHER ECONOMIC LOSSES, OR STATUTORY OR EXEMPLARY DAMAGES, WHETHER IN NEGLIGENCE, WARRANTY, STRICT LIABILITY, OR OTHERWISE.**

This warranty applies only to the first purchaser from a retail dealer. No warranty is given to subsequent transferees. A copy of the original receipt or proof of purchase directly from Winco or Winco's authorized dealer/distributor is required for warranty coverage. **This warranty is not in force until such time as a properly completed and digitally signed Installation/Warranty Registration has been received by WINCO within 30 days from the date of installation.**

This warranty does not cover damage caused by improper installation and/or use, neglect, failure to properly maintain, modifications, damage due to excess water or fire, or normal wear. Periodic maintenance is not covered.

DO NOT send unit to WINCO without first contacting our customer service department.

## LIMITED WARRANTY ~ SHELVING

WINCO®/DWL Industries Co. warrants that shelving products of our manufacture, when properly installed within USA and Canada, and subjected to normal use, are free from defects in material or workmanship for a period of up to ten (10) years.

Determination of repair or replacement will be at the sole discretion of Winco.

This warranty does not cover damage caused by improper installation and/or use, overloading, accident, improper storage, or neglect, alterations, modifications, or additions.

## LIMITED LIFETIME WARRANTY ~ CUTLERY AND TURNERS

All Winco®/DWL Industries Co. Acero™, Stal™ and Coolheat™ products are guaranteed against defects in workmanship and material for the life of the product.

Our products are designed to last when used as intended. The sole and exclusive remedy under this warranty is the replacement or repair of the defective product. Winco® reserves the right to inspect products for misuse.

### WARRANTY EXCLUSIONS

This warranty does not cover against misuse or any other subsequent conditions such as those attributable to the use of the product for purposes other than in accordance with generally accepted best industry practices. This includes, but is not limited to neglect, accident, alterations, surface markings, minor imperfections and normal wear.



To submit a warranty claim, contact Winco®/DWL Industries Co. at: [support@wincous.com](mailto:support@wincous.com)

# 2018

01/18



DWL Industries Co.

---

**East Coast**

65 Industrial Road  
Lodi, NJ 07644

Tel. 1.888.946.2682  
Fax. 1.888.946.2632

**West Coast**

14950-14952 Valley View Ave  
La Mirada, CA 90638

Tel. 1.888.946.2652  
Fax. 1.562.926.5678

*Check your order status online at [www.wincous.com](http://www.wincous.com)*